

Tropical Intersection Products and Families of Tropical Curves

Georges François

Vom Fachbereich Mathematik
der Technischen Universität Kaiserslautern
zur Verleihung des akademischen Grades
Doktor der Naturwissenschaften
(Doctor rerum naturalium, Dr. rer. nat.)
genehmigte Dissertation

1. Gutachter: Professor Andreas Gathmann
2. Gutachter: Assistant Professor Sam Payne

Vollzug der Promotion: 15.11.2012

D 386

Contents

Preface	5
Chapter 1. Preliminaries – the existing tropical intersection theory	7
1.1. Tropical cycles in vector spaces and morphisms	7
1.2. Intersecting with rational functions	14
1.3. Intersecting cycles in vector spaces	18
1.4. Rational and numerical equivalence	20
Chapter 2. Piecewise polynomials and tropical cocycles	23
2.1. Intersecting with piecewise polynomials	23
2.2. Abstract tropical cycles	33
2.3. Intersecting with tropical cocycles	35
Chapter 3. Intersection theory on matroid varieties	39
3.1. Matroid varieties	40
3.2. Matroid quotients and rational functions	47
3.3. The intersection product on matroid varieties	51
3.4. Dividing out the lineality space	58
3.5. Intersection product on smooth varieties	64
3.6. Pull-back of cycles	65
3.7. Rational equivalence on matroid varieties	72
3.8. Cocycles on smooth varieties and more pull-backs	76
Chapter 4. Intersection theory on the moduli space \mathcal{M}_n and families of curves	81
4.1. Intersection product on the moduli space of rational curves	81
4.2. Tropical fibre products I	85
4.3. Families of curves and the forgetful map	89
4.4. Morphisms into \mathcal{M}_n induce families of curves	92
4.5. Tropical fibre products II	94
Bibliography	97

Preface

Tropical geometry

Tropical geometry is a rather new field of algebraic geometry that uses combinatoric methods to study algebro-geometric questions. A certain tropicalisation process assigns a pure-dimensional polyhedral complex in \mathbb{R}^n to each algebraic variety. The resulting tropical objects inherit many properties from the initial varieties and are often easier to work with; therefore, the aim is to transfer results back from the tropical to the algebraic side. Tropical geometry has been successfully applied to many areas of algebraic geometry such as enumerative geometry, elimination theory [ST08], Brill-Noether theory [CDPR12], and the study of real inflection points of real algebraic curves [BLdM12].

The starting point for the success of tropical methods in enumerative geometry has been Mikhalkin's correspondence theorem [Mik05] which states that, in many cases, counting tropical curves leads to the same result as counting algebraic curves. Thereafter, tropical geometry has been used to achieve many new insights and results in both complex and real enumerative geometry including [GM07b, BBM, SS] in the complex case and [IKS09, GMS, IKS] in the real case.

As in classical algebraic geometry, an elaborated intersection theory is expected to become an extremely important tool in tropical enumerative geometry. This is why this thesis aims to extend and generalise the existing tropical intersection theory as well as to apply intersection theory to gain new insights about tropical moduli spaces. We take a combinatorial approach to tropical geometry, which means that we work with tropical objects regardless of whether they are tropicalisations of algebraic varieties. However, tropicalisations are an important class of examples, and the classical theory often serves as a guide to its tropical counterpart.

Results of this thesis

The following is a list of the main results of this thesis:

- In proposition 2.1.6 we show the connection between tropical intersection products with rational functions and intersection products of piecewise polynomials with complete fans, which describe the canonical map from equivariant to ordinary Chow cohomology groups of the corresponding toric varieties.
- We use piecewise polynomials as local ingredients to establish the notion of tropical cocycles and define an intersection product of cocycles with (abstract) tropical cycles in section 2.3. Using the connection to toric geometry, we prove the Poincaré duality for vector spaces in theorem 2.3.10. Furthermore, we show in theorem 3.8.1 that each subcycle of a matroid variety can be cut out by a cocycle. If the subcycle has dimension 0 or codimension 1, then there is exactly one such cocycle (cf. corollary 3.8.8).

- For any matroid variety contained in another matroid variety, corollary 3.2.15 gives explicit rational functions whose inductive intersection product with the bigger matroid variety is the smaller one.
- In definition 3.3.3 we construct an intersection product of cycles on matroid varieties (and hence also on smooth varieties) via intersection with the diagonal, thus generalising the intersection products of [AR10] and [All12]. By theorem 3.7.9 our intersection product of cycles also agrees with the recursive intersection product constructed in [Sha].
- In section 3.6 we generalise the construction of the pull-back of cycles given in [All12] to morphisms whose domain and target space locally look like matroid varieties and relate our pull-back to tropical modifications and to pull-backs of cohomology classes on complete toric varieties.
- Theorem 3.7.6 states that every cycle in a matroid variety is rationally equivalent to a unique fan cycle and thus generalises the corresponding result for vector spaces in [AR].
- We show in theorem 4.1.5 that moduli spaces of n -marked abstract rational curves are matroid varieties (modulo lineality spaces) and thus admit an intersection product of cycles.
- We introduce a tropical fibre product in sections 4.2 and 4.5 .
- Sections 4.3 and 4.4 are devoted to defining families of curves over smooth varieties and showing that every morphism from a smooth variety to the moduli space of abstract rational curves induces a family of curves. Furthermore, corollary 4.5.8 states that one can pull back families of curves along morphisms of smooth varieties.
- We introduce an alternative, inductive way of constructing moduli spaces of n -marked abstract rational curves in section 4.4; this is done by taking the modification along the diagonal of the fibre product of two copies of the moduli space over the forgetful maps.

The thesis contains material from my articles [FR], [Fra] and [FH]. In particular, part of the thesis is the outcome of joint work with Johannes Rau and Simon Hampe. The introduction of each chapter contains information about the contributions each of us made.

Financial support

I am grateful for the financial support I received from the Fonds National de la Recherche Luxembourg under the framework of its AFR PhD programme (grant reference: PHD-09-073).

Acknowledgement

I thank my advisor Andreas Gathmann for his support and his great supervision.

I thank my coauthors Johannes Rau and Simon Hampe for the excellent collaboration.

I thank my present and former colleagues Lars Allermann, Jens Demberg, Joke Frels, Simon Hampe, Matthias Herold, Henning Meyer, Dennis Ochse, Johannes Rau, Kirsten Schmitz, Carolin Torchiani and Anna Lena Winstel as well as my advisor Andreas Gathmann for the superb atmosphere in our working group.

I thank my parents for their boundless support.

我感谢我的爱人刘璐。

Preliminaries – the existing tropical intersection theory

In this introductory chapter we recall the main constructions and results of the previously existing tropical intersection theory. The chosen approach is purely tropical and does not rely on any classical or toric results. The intersection product of rational functions with tropical cycles constitutes the heart of the theory outlined in this chapter and is the main ingredient for the construction of an intersection product of cycles in vector spaces. A remarkable difference to the classical theory is that tropical rational functions can be restricted to any subcycle, without risking to become identically $-\infty$ (the tropical zero) on a component. This leads to the pleasant situation that tropical intersection products can be computed on the level of cycles, rather than only on classes modulo rational equivalence.

This chapter mainly covers the theory developed by Lars Allermann and Johannes Rau in [AR10, AR]. However, our presentation of the material follows to a great extent the presentation used in [Rau09].

1.1. Tropical cycles in vector spaces and morphisms

In this section we recall the very basic definitions and constructions of tropical intersection theory. In particular, the section covers tropical cycles, sums of cycles, stars of cycles around cells as well as tropical morphisms and push-forwards of cycles.

Notation 1.1.1. In this thesis $V = \Lambda \otimes_{\mathbb{Z}} \mathbb{R}$ will always denote the real vector space associated to a lattice (that is a free \mathbb{Z} -module of finite rank) Λ .

Definition 1.1.2. A (rational convex) polyhedron in V is a set of the form

$$\sigma = \{x \in V : \lambda_1(x) = a_1, \dots, \lambda_r(x) = a_r, \lambda_{r+1}(x) \geq a_{r+1}, \dots, \lambda_s(x) \geq a_s\},$$

for some integer linear forms λ_i in the dual lattice Λ^\vee and some $a_i \in \mathbb{R}$. Faces τ of a polyhedron σ are strict subsets of σ that are obtained by changing some of the defining inequalities into equalities; in this situation we write $\sigma > \tau$. (We sometimes use the notation $\sigma \geq \tau$ if we do not want to exclude $\sigma = \tau$.) We denote by V_σ the linear subspace of V generated by (differences of vectors in) a polyhedron σ . Accordingly we set $\Lambda_\sigma := \Lambda \cap V_\sigma$. The dimension of a polyhedron σ is just the vector space dimension of V_σ . A cone is a polyhedron whose defining equalities and inequalities can be chosen to satisfy $a_i = 0$ for all i .

Definition 1.1.3. A polyhedral complex \mathcal{X} is a finite set of polyhedra in V satisfying

- Every face of a polyhedron in \mathcal{X} is again in \mathcal{X} .
- The intersection of two polyhedra in \mathcal{X} is a face of both (and thus again in \mathcal{X}).

Following [Rau09] we often refer to elements of a polyhedral complex as cells. A polyhedral complex is pure-dimensional if all its maximal cells have the same dimension; its dimension is then the dimension of its maximal cells. We denote the set of d -dimensional cells in \mathcal{X} by $\mathcal{X}^{(d)}$, and set $\mathcal{X}^{(\leq d)} := \cup_{i=0}^d \mathcal{X}^{(i)}$. Top-dimensional cells are called facets, whereas one- and zero-dimensional cells are called edges and vertices respectively. A fan is a polyhedral complex all of whose cells are cones.

Example 1.1.4. Let \mathcal{X}, \mathcal{Y} be polyhedral complexes in V and let \mathcal{X}' be a polyhedral complex in V' . Then the intersection

$$\mathcal{X} \cap \mathcal{Y} := \{\sigma \cap \alpha : \sigma \in \mathcal{X}, \alpha \in \mathcal{Y}\}$$

is a polyhedral complex in V and the cross product

$$\mathcal{X} \times \mathcal{X}' := \{\sigma \times \sigma' : \sigma \in \mathcal{X}, \sigma' \in \mathcal{X}'\}$$

is polyhedral complex in $V \times V'$. If \mathcal{X}, \mathcal{Y} (resp. $\mathcal{X}, \mathcal{X}'$) are fans, then so is their intersection (resp. cross product). The cross product of pure-dimensional polyhedral complexes is again pure-dimensional, whereas the intersection of pure-dimensional polyhedral complexes is in general not pure-dimensional.

Example 1.1.5. Let λ be an integer linear form and let $a \in \mathbb{R}$. Then the set

$$\mathcal{H}_{(\lambda, a)} := \{\{x \in V : \lambda(x) \geq a\}, \{x \in V : \lambda(x) \leq a\}, \{x \in V : \lambda(x) = a\}\}$$

is a polyhedral complex in V . If $a = 0$, then $\mathcal{H}_\lambda := \mathcal{H}_{(\lambda, 0)}$ is a complete fan (that is a fan the union of whose cones is equal to the whole vector space V).

Definition 1.1.6. A weighted polyhedral complex is a pure-dimensional polyhedral complex together with a weight function $\omega_{\mathcal{X}} : \mathcal{X}^{(\dim \mathcal{X})} \rightarrow \mathbb{Z}$ on its facets. The support $|\mathcal{X}| \subseteq V$ of a weighted polyhedral complex is the union of the facets of non-zero weight.

Definition 1.1.7. Let τ be a face of codimension 1 of a polyhedron σ . We call $v_{\sigma/\tau} \in \Lambda$ a (representative of the) primitive normal vector of σ modulo τ if the following conditions hold:

- The class of $v_{\sigma/\tau}$ generates $\Lambda_\sigma/\Lambda_\tau$, that means $\mathbb{Z} \cdot v_{\sigma/\tau} + \Lambda_\tau = \Lambda_\sigma$.
- If λ is a linear form whose minimal locus on σ is τ , then $\lambda(v_{\sigma/\tau}) > 0$.

Definition 1.1.8. A weighted polyhedral complex \mathcal{X} is called balanced (or tropical) if it satisfies the following balancing condition for every codimension one cell $\tau \in \mathcal{X}^{(\dim \mathcal{X}-1)}$:

$$\sum_{\sigma \in \mathcal{X} : \sigma > \tau} \omega_{\mathcal{X}}(\sigma) \cdot v_{\sigma/\tau} \in V_\tau.$$

The following pictures show a 1-dimensional tropical polyhedral complex (with vertices $(0, 0)$, $(1, 1)$, $(5/2, 3/2)$) and the 2-dimensional tropical fan \mathcal{L}_2^3 defined in the next example.

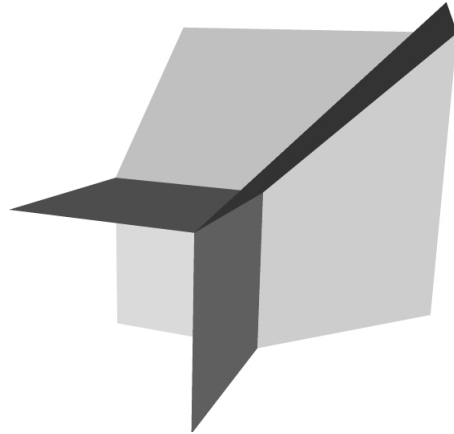
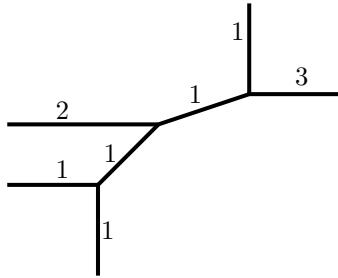

Example 1.1.9. Let $\Lambda = \mathbb{Z}^n$ and let $\{e_1, \dots, e_n\}$ be the standard basis of \mathbb{R}^n and $e_0 := -(e_1 + \dots + e_n)$. For $I \subsetneq \{0, 1, \dots, n\}$ we define the $|I|$ -dimensional cone

$$\sigma_I := \langle -e_i : i \in I \rangle := \left\{ \sum_{i \in I} \lambda_i (-e_i) : \lambda_i \geq 0 \right\}.$$

For $k \in \{0, 1, \dots, n\}$ the pure-dimensional fan \mathcal{L}_k^n consists of cones σ_I , with $|I| \leq k$. By assigning each maximal cone of \mathcal{L}_k^n the trivial weight 1, we obtain a balanced fan: If $|I| = k - 1$, then the maximal cones around σ_I in \mathcal{L}_k^n are $\sigma_{I \cup \{i\}}$, with $i \notin I$. Moreover, we have $v_{\sigma_{I \cup \{i\}}/\sigma_I} = -e_i$. Since

$$\sum_{i \notin I} -e_i = \sum_{i \in I} e_i \in V_{\sigma_I}$$

we can conclude that \mathcal{L}_k^n is balanced. Note that the support of \mathcal{L}_k^n is the set of points (x_1, \dots, x_n) in \mathbb{R}^n such that the maximum $\max\{x_1, \dots, x_n, 0\}$ is attained at least $n - k + 1$ times.

Definition 1.1.10. Let \mathcal{X}, \mathcal{Y} be two weighted polyhedral complexes in V . Then \mathcal{Y} is a refinement of \mathcal{X} if the following hold:

- There is an equality of supports $|\mathcal{X}| = |\mathcal{Y}|$.
- Every cell $\alpha \in \mathcal{Y}$ with $\alpha \subseteq |\mathcal{Y}|$ is contained in a cell of \mathcal{X} .
- If σ is the unique facet in \mathcal{X} containing the facet $\alpha \in \mathcal{Y}$ (of non-zero weight), then their weights agree: $\omega_{\mathcal{X}}(\sigma) = \omega_{\mathcal{Y}}(\alpha)$.

Definition 1.1.11. Note that the previous definitions only give conditions on cells of non-zero weight. Cells of weight zero solely exist for technical reasons (for example to be able to define the sum of two tropical cycles).

Remark 1.1.12. Let \mathcal{X}, \mathcal{Y} be two weighted polyhedral complexes of dimension d with $|\mathcal{X}| \subseteq |\mathcal{Y}|$. Assigning their intersection the weight function of \mathcal{X} , i.e. setting

$$\omega_{\mathcal{X} \cap \mathcal{Y}}(\sigma \cap \alpha) := \omega_{\mathcal{X}}(\sigma),$$

for cells $\sigma \in \mathcal{X}, \alpha \in \mathcal{Y}$ whose intersection is of dimension d , turns $\mathcal{X} \cap \mathcal{Y}$ into a refinement of \mathcal{X} . If $|\mathcal{X}| = |\mathcal{Y}|$, then $\mathcal{X} \cap \mathcal{Y}$ is a common refinement of \mathcal{X} and \mathcal{Y} if and only if we have $\omega_{\mathcal{X}}(\sigma) = \omega_{\mathcal{Y}}(\alpha)$ for every facets whose intersection $\sigma \cap \alpha$ is of dimension d . Therefore,

$$\mathcal{X} \sim \mathcal{Y} :\Leftrightarrow \mathcal{X} \cap \mathcal{Y} \text{ is a refinement of } \mathcal{X} \text{ and } \mathcal{Y}$$

is an equivalence relation of weighted polyhedral complexes.

Remark 1.1.13. Let \mathcal{Y} be a refinement of \mathcal{X} . Let $\sigma \in \mathcal{X}$ be the inclusion-minimal cell containing the codimension 1 cell $\alpha \in \mathcal{Y}$. If $\dim \sigma > \dim \alpha$, then all $\beta \in \mathcal{Y}$ with $\beta > \alpha$ have to be contained in σ ; it follows that there are exactly two such cells and that they have opposite primitive normal vectors. As they have the same weight by the definition of refinement, we see that \mathcal{Y} is balanced around α in this case. If $\dim \sigma = \dim \alpha$, then there is a bijection between facets in \mathcal{Y} around α and facets in \mathcal{X} around σ which preserves weights and primitive normal vectors. It follows that \mathcal{Y} is balanced if and only if \mathcal{X} is balanced.

Definition 1.1.14. A tropical cycle X in a vector space V is an equivalence class of balanced polyhedral complexes (in V) modulo refinement. If \mathcal{X} is a representative of the tropical cycle X , then we say that \mathcal{X} is a polyhedral structure of X and that X is the cycle associated to \mathcal{X} . The support $|X|$ and the dimension $\dim X$ of a tropical cycle X are just the support and the dimension of a polyhedral structure of X . Note that the dimension of the cycle $X = \emptyset$ is not well-defined. A fan cycle X is the cycle associated to a balanced fan, which in turn is called a fan structure of X . A tropical (fan) cycle associated to a balanced polyhedral complex all of whose weights are non-negative is called tropical (fan) variety.

Example 1.1.15. The fan cycle associated to \mathcal{L}_k^n (cf. example 1.1.9) is denoted by L_k^n .

Example 1.1.16. Let $\mathcal{X}, \mathcal{X}'$ be polyhedral structures of tropical cycles X, X' in vector spaces V, V' . Then it is easy to see that the polyhedral complex $\mathcal{X} \times \mathcal{X}'$ together with the weight function

$$\omega_{\mathcal{X} \times \mathcal{X}'}(\sigma \times \sigma') := \omega_{\mathcal{X}}(\sigma) \cdot \omega_{\mathcal{X}'}(\sigma')$$

is a balanced polyhedral complex. We denote by $X \times X'$ the cycle associated to $\mathcal{X} \times \mathcal{X}'$. We easily see that $|X \times X'| = |X| \times |X'|$.

The following remark introduces an important class of tropical varieties – tropicalisations of algebraic varieties.

Remark 1.1.17. The algebraically closed field of Puiseux series $K := \mathbb{C}\{\{t\}\}$ over \mathbb{C} has elements $\sum_{i \in \mathbb{N}} c_i t^{a_i}$, where the c_i are non-zero complex numbers and $a_1 < a_2 < a_3 < \dots$ are rational numbers having a common denominator. It comes with the natural valuation

$$\text{val} : K^* \rightarrow \mathbb{Q} \subseteq \mathbb{R}, \quad \sum_{i \in \mathbb{N}} c_i t^{a_i} \mapsto a_1.$$

Componentwise taking the negative of this valuation gives the map

$$\text{Val} : (K^*)^n \rightarrow \mathbb{R}^n, \quad (x_1, \dots, x_n) \mapsto (-\text{val}(x_1), \dots, -\text{val}(x_n)).$$

Now let $I \subseteq K[x_1, x_1^{-1}, \dots, x_n, x_n^{-1}]$ be a prime ideal and $V(I) \subseteq (K^*)^n$ the associated irreducible algebraic variety in the torus. Then the closure in \mathbb{R}^n of the image of $V(I)$ under the valuation map Val is the support of a $(\dim V(I))$ -dimensional tropical variety $\text{Trop}(V(I))$, i.e. we have

$$\overline{\text{Val}(V(I))} = |\text{Trop}(V(I))|.$$

The tropical variety $\text{Trop}(V(I))$ can be obtained in the following way: For a polynomial $f = \sum b_u x^u \in K[x_1, x_1^{-1}, \dots, x_n, x_n^{-1}]$ and a point $p \in \mathbb{R}^n$ one sets

$$W_p := \max \left\{ \text{val}(b_u) + \sum_{i=1}^n p_i u_i : b_u \neq 0 \right\},$$

as well as

$$U_p := \left\{ u : b_u \neq 0, \text{val}(b_u) + \sum_{i=1}^n p_i u_i = W_p \right\},$$

and defines the initial form of f with respect to p to be

$$\text{in}_p(f) := \sum_{u \in U_p} h(b_u) x^u \in \mathbb{C}[x_1, x_1^{-1}, \dots, x_n, x_n^{-1}],$$

where $h(\sum_{i \in \mathbb{N}} c_i t^{a_i}) := c_1 \in \mathbb{C}$. The initial ideal of I with respect to p is

$$\text{in}_p(I) := \langle \text{in}_p(f) : f \in I \rangle.$$

The fundamental theorem of tropical geometry states that we have an equality

$$\{p \in \mathbb{R}^n : \text{in}_p(I) \neq \langle 1 \rangle\} = \overline{\text{Val}(V(I))}.$$

It turns out that this set is the support of a (not canonically defined) pure-dimensional rational polyhedral complex \mathcal{X} such that $\text{in}_p(I)$ is constant on the relative interior of every cell. It has been shown that the polyhedral complex \mathcal{X} can be made balanced by giving it the weight function

$$\omega_{\mathcal{X}}(\sigma) = \sum_{P \in \text{Ass}(\text{in}_p(I))} \text{mult}(P, \text{in}_p(I)),$$

where p is any point in the relative interior of σ and the sum runs over the associated prime ideals of $\text{in}_p(I)$. Now $\text{Trop}(V(I))$ is the tropical variety associated to \mathcal{X} and is called the tropicalisation of $V(I)$. If I can be generated by polynomials whose coefficients are in \mathbb{C} (rather than in K), then $\text{Trop}(V(I))$ is a fan variety; this is often referred to as the constant coefficient case. More details about tropicalisations of algebraic varieties can be

found in numerous articles (using various approaches) such as [EKL06], [Spe05, chapter 2], [SS04, section 2], [Dra08, section 4], [Kat09, lemma 4.15], [JMM08], [Pay09, Pay] and [MS, chapter 3].

Definition 1.1.18. A cycle Y is a subcycle of the cycle X if $|Y| \subseteq |X|$. The set of k -dimensional subcycles of X is denoted by $Z_k(X)$. If X is a fan cycle, then $Z_k^{\text{fan}}(X)$ is the set of its k -dimensional fan subcycles.

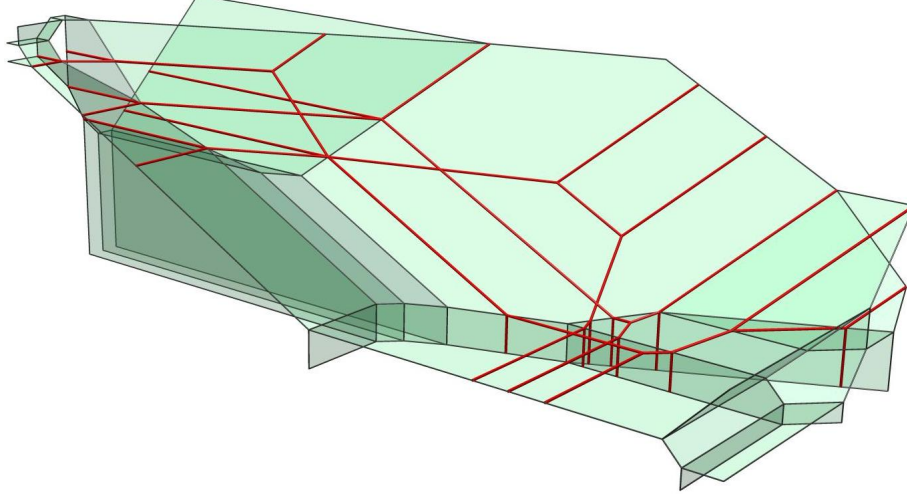

A curve in a tropical surface

In order to be able to define a sum of tropical cycles we need the following lemma.

Lemma 1.1.19. Let Y_1, Y_2 be subcycles of a cycle X . Then there are polyhedral structures $\mathcal{Y}_1, \mathcal{Y}_2, \mathcal{X}$ of Y_1, Y_2, X such that the underlying polyhedral complexes satisfy

$$\mathcal{Y}_i = \mathcal{X}^{(\leq \dim Y_i)}.$$

If Y_1, Y_2, X are fan cycles, then they also have fan structures fulfilling the above property.

PROOF. We choose arbitrary polyhedral structures $\tilde{\mathcal{Y}}_i, \tilde{\mathcal{X}}$ of Y_i, X . Let $\lambda_1, \dots, \lambda_s$ be integer linear forms and a_1, \dots, a_s real numbers such that every cell in the union $\tilde{\mathcal{Y}}_1 \cup \tilde{\mathcal{Y}}_2 \cup \tilde{\mathcal{X}}$ can be written as

$$\{x \in V : \lambda_j(x) = a_j, \lambda_p(x) \geq a_p : j \in J, p \in P\}$$

for suitable subsets $J, P \subseteq \{1, \dots, s\}$. Now we define for $\mathcal{Z} \in \{\mathcal{Y}_1, \mathcal{Y}_2, \mathcal{X}\}$ that

$$\bar{\mathcal{Z}} := \tilde{\mathcal{Z}} \cap \mathcal{H}_{(\lambda_1, a_1)} \cap \dots \cap \mathcal{H}_{(\lambda_s, a_s)}$$

(cf. example 1.1.5 and remark 1.1.12). By construction, $\bar{\mathcal{Y}}_1, \bar{\mathcal{Y}}_2, \bar{\mathcal{X}}$ are polyhedral structures of Y_1, Y_2, X , and every cell of $\bar{\mathcal{Y}}_i$ is also a cell of $\bar{\mathcal{X}}$. Finally, we set $\mathcal{X} := \bar{\mathcal{X}}$ and define \mathcal{Y}_i to be the polyhedral complex $\mathcal{X}^{(\leq \dim Y_i)}$ with the weight function

$$\omega_{\mathcal{Y}_i}(\sigma) := \begin{cases} \omega_{\bar{\mathcal{Y}}_i}(\sigma), & \text{if } \sigma \in \bar{\mathcal{Y}}_i \\ 0, & \text{else} \end{cases}.$$

It is obvious that the whole construction can be performed on the level of fans if all involved cycles are fan cycles. \square

Construction 1.1.20. Let $Y_1, Y_2 \in Z_k(X)$ be two subcycles of X . Lemma 1.1.19 allows us to choose polyhedral structures $\mathcal{Y}_1, \mathcal{Y}_2$ of Y_1, Y_2 which are equal as polyhedral complexes. (Note that in general these \mathcal{Y}_i have cells of weight zero.) Then the sum $Y_1 + Y_2$ is just the cycle associated to the above polyhedral complex with weight function $\omega_{\mathcal{Y}_1} + \omega_{\mathcal{Y}_2}$. As $|Y_1 + Y_2| \subseteq |Y_1| \cup |Y_2| \subseteq |X|$, $Y_1 + Y_2$ is again a subcycle of X . It follows that the

addition of cycles turns $Z_k(X)$ into a group with neutral element \emptyset . One can see in the same way that $Z_k^{\text{fan}}(X)$ is a group if X is a fan cycle.

Remark 1.1.21. By linearly extending the tropicalisation process of remark 1.1.17, one can define the tropicalisation of a pure-dimensional algebraic cycle $\sum_{i=1}^p \lambda_i X_i$ in $(K^*)^n$ to be the tropical cycle $\sum_{i=1}^p \lambda_i \text{Trop}(X_i)$ in \mathbb{R}^n .

Let \mathcal{X} be a polyhedral structure of a tropical cycle X . The next construction shows how to turn the neighbourhood $U(\tau) := \cup_{\sigma \in \mathcal{X}: \sigma \geq \tau} \text{Int}(\sigma)$ of a cell $\tau \in \mathcal{X}$ into a tropical cycle. Here $\text{Int}(\sigma)$ denotes the relative interior of the cell σ . This will be very useful to perform intersection-theoretic computations locally.

Definition and Construction 1.1.22. Let \mathcal{X} be a polyhedral structure of a cycle X and let $\tau \in \mathcal{X}$ be a cell. Consider the quotient map $q: V \rightarrow V_\tau$. For a cell $\sigma \geq \tau$ we denote by $\bar{\sigma}$ the cone generated by the image $q(\{x - y : x \in \sigma, y \in \tau\})$. The star of \mathcal{X} around τ is the weighted fan

$$\text{Star}_{\mathcal{X}}(\tau) := \{\bar{\sigma} : \sigma \in \mathcal{X}, \sigma \geq \tau\}, \text{ with } \omega_{\text{Star}_{\mathcal{X}}(\tau)}(\bar{\sigma}) := \omega_{\mathcal{X}}(\sigma).$$

The balancing of \mathcal{X} clearly implies the balancing of $\text{Star}_{\mathcal{X}}(\tau)$; so one can denote its associated fan cycle by $\text{Star}_X(\tau)$.

If p is a point in X , then we see that the support $|\text{Star}_X(p)|$ consists of vectors $v \in V$ such that $p + \epsilon v \in |X|$ for small, positive ϵ .

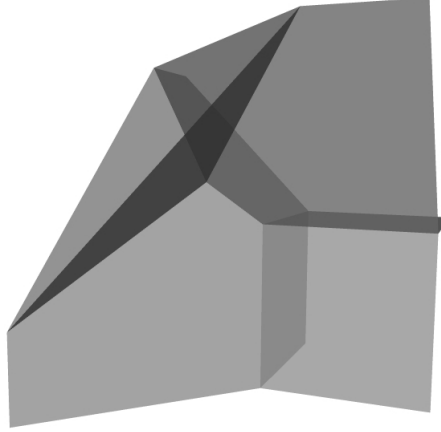

The star of $\max\{0, x, y, z, x + y + z - 1\} \cdot \mathbb{R}^3$ around the origin is L_2^3 .

Remark 1.1.23. The star around a point of the tropicalisation of an algebraic variety is again the tropicalisation of an algebraic variety, namely

$$\text{Star}_{\text{Trop}(V(I))}(p) = \text{Trop}(V(\text{in}_p(I))).$$

This was proved in [Spe05, proposition 2.2.3] and [MS, proposition 3.3.5].

Definition 1.1.24. A cycle X is called irreducible if every $(\dim X)$ -dimensional subcycle of X is an integer multiple of X . A balanced polyhedral complex is locally irreducible if the greatest common divisor of all its (non-zero) weights is 1 and for all $\tau \in \mathcal{X}^{(\dim \mathcal{X} - 1)}$ the star $\text{Star}_{\mathcal{X}}(\tau)$ is either a multiple of a vector space or an irreducible curve. It is an easy consequence of [Rau09, remark 1.2.11] that local irreducibility is preserved under refinement; this allows us to call a tropical cycle locally irreducible if it has a locally irreducible polyhedral structure.

Definition 1.1.25. A pure-dimensional polyhedral complex \mathcal{X} is connected in codimension 1 if for any maximal cells $\sigma, \alpha \in \mathcal{X}$ there is a sequence of maximal cells $\sigma = \sigma_1, \sigma_2, \dots, \sigma_r = \alpha$ in \mathcal{X} such that the intersection of two consecutive cells $\sigma_i \cap \sigma_{i+1}$

is of codimension 1. A tropical cycle X is called connected in codimension 1 if some (and thus any) polyhedral structure of X is connected in codimension 1.

Proposition 1.1.26 ([Rau09, lemma 1.2.29]). *Let X be a locally irreducible cycle which is connected in codimension 1. Then X is also irreducible.*

Definition 1.1.27. A map $V \supseteq A \rightarrow V'$ is called integer affine linear if it is a sum $l + v'$, where $v' \in V'$ and l is induced by a \mathbb{Z} -linear map $\Lambda \rightarrow \Lambda'$ on the associated lattices. Let X, Y be tropical cycles. A morphism $f : X \rightarrow Y$ is a map from $|X|$ to $|Y|$ which is locally integer affine linear. We call polyhedral structures \mathcal{X}, \mathcal{Y} of X, Y compatible with respect to the morphism f if $f(\sigma) \in \mathcal{Y}$ for all $\sigma \in \mathcal{X}$. A morphism f is an isomorphism if there is a morphism $g : Y \rightarrow X$ such that $f \circ g = \text{id}_Y$, $g \circ f = \text{id}_X$ and $\omega_{\mathcal{X}}(\sigma) = \omega_{\mathcal{Y}}(f(\sigma))$ for all cells $\sigma \in \mathcal{X}$ for some (and thus any) compatible polyhedral structures \mathcal{X}, \mathcal{Y} of X, Y . Note that each morphism admits compatible polyhedral structures (cf. [Rau09, lemma 1.3.4]).

Remark 1.1.28. Let $f : X \rightarrow Y$ be a morphism and let \mathcal{X}, \mathcal{Y} be compatible polyhedral structures of X, Y . Let $\tau \in \mathcal{X}$. The morphism f is affine linear in a neighbourhood around τ (cf. [Rau09, remark 1.3.2]). As $\sigma > \tau$ in \mathcal{X} implies that $f(\sigma) \geq f(\tau)$ in \mathcal{Y} the linear part of f around τ induces a morphism $f^\tau : \text{Star}_X(\tau) \rightarrow \text{Star}_Y(f(\tau))$.

Definition 1.1.29. Let $f : X \rightarrow Y$ be a morphism of tropical cycles X in V and Y in V' . Let \mathcal{X}, \mathcal{Y} be polyhedral structures of X, Y which are compatible with respect to f . Then the push-forward $f_*X \in Z_{\dim X}(Y)$ of X along f is the cycle associated to the polyhedral complex

$$f_*\mathcal{X} := \{f(\sigma) : \sigma \in \mathcal{X} \text{ is contained in a maximal cell of } \mathcal{X} \text{ on which } f \text{ is injective}\},$$

with weight function

$$\omega_{f_*\mathcal{X}}(\alpha) := \sum_{\substack{\sigma \in \mathcal{X}(\dim X) \\ f(\sigma) = \alpha}} \omega_{\mathcal{X}}(\sigma) \cdot |\Lambda'_\alpha / f_\sigma(\Lambda_\sigma)|,$$

where the second term in the sum is the cardinality of the finite group $\Lambda'_\alpha / f_\sigma(\Lambda_\sigma)$ and f_σ is the linear part of f around σ . Note that it was shown in [Rau09, lemma 1.3.6] (and in [GKM09, proposition 2.25] in the case of fan cycles) that the weighted polyhedral complex $f_*\mathcal{X}$ is balanced. The push-forward of a subcycle C of X along f is defined to be the push-forward of the restriction of f to C , i.e. $f_*C := (f|_C)_*C$. This gives us a homomorphism of groups

$$f_* : Z_d(X) \rightarrow Z_d(Y), C \mapsto f_*C.$$

Example 1.1.30. Let $\pi : \mathbb{R}^2 \rightarrow \mathbb{R}$ be the projection to the first coordinate. We want to compute the push-forward π_*C of the curve C depicted below. Note that the depicted polyhedral structures of C and \mathbb{R} are compatible with respect to the morphism π and that all weights are assumed to be 1, unless told otherwise.

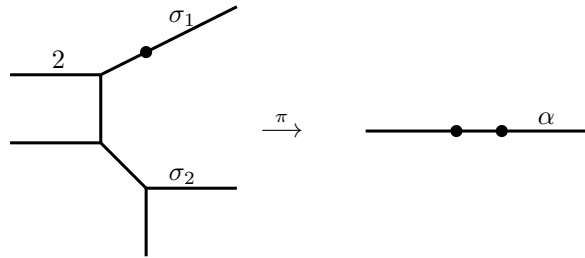

Then $\pi_*C = 3 \cdot \mathbb{R}$: For example

$$\omega_{\pi_*C}(\alpha) = \omega_C(\sigma_1) \cdot |\mathbb{Z}/2\mathbb{Z}| + \omega_C(\sigma_2) \cdot |\mathbb{Z}/\mathbb{Z}| = 2 + 1 = 3,$$

where \mathcal{C} is the polyhedral structure of C shown in the picture. In the same way we can compute that the push-forward of C along the projection to the second coordinate is equal to $1 \cdot \mathbb{R}$.

Proposition 1.1.31. *Let $f : X \rightarrow Y, g : Y \rightarrow Z, f' : X' \rightarrow Y'$ be morphisms of tropical cycles. Let C, D, C' be subcycles of X, Y, X' . Then the following hold:*

- $|f_*C| \subseteq |f(C)|$
- $(g \circ f)_*C = g_*(f_*C)$
- $(f \times f')_*(C \times C') = f_*C \times f'_*C'$.
- *Push-forwards are local in the following sense: If \mathcal{X}, \mathcal{Y} are compatible polyhedral structures of X, Y and $\alpha \in \mathcal{Y}^{(k)}$, then*

$$\text{Star}_{f_*\mathcal{X}}(\alpha) = \sum_{\sigma \in \mathcal{X}^{(k)}: f(\sigma)=\alpha} |\Lambda'_\alpha / f_\sigma(\Lambda_\sigma)| \cdot f_*^\sigma \text{Star}_{\mathcal{X}}(\sigma).$$

PROOF. Proofs of the second and fourth statement can be found in [Rau09, remark 1.3.9] and [Rau09, lemma 1.3.7]. The other statements are obvious. \square

1.2. Intersecting with rational functions

In this section we outline the construction of intersecting tropical cycles with rational functions introduced in [AR10, section 3]. We also state the main properties of this intersection product, most notably the projection formula which connects the notions of pull-back and push-forward.

Definition 1.2.1. Let X be a tropical cycle. A rational function on X is a piecewise affine linear function $\varphi : |X| \rightarrow \mathbb{R}$; that means there is a polyhedral structure \mathcal{X} of X such that φ is integer affine linear on every cell of \mathcal{X} . In other words, the restriction of φ to each cell $\sigma \in \mathcal{X}$ is a sum $\varphi|_\sigma = \varphi_\sigma + a_\sigma$ of an integer linear form $\varphi_\sigma \in \Lambda_\sigma^\vee$ and a real constant a_σ . We define $\mathbb{R}(X)$ to be the (additive) group of rational functions on X .

A rational fan function on a fan cycle X is a rational function which is linear on the cones of some fan structure of X . The group of rational fan functions is denoted by $\mathbb{R}^{\text{fan}}(X)$.

Definition 1.2.2. Let φ be a rational function on the cycle X and let \mathcal{X} be a polyhedral structure of X such that φ is affine linear on every cell of \mathcal{X} . We define the weighted polyhedral complex $\varphi \cdot \mathcal{X}$ to be the polyhedral complex $\mathcal{X} \setminus \mathcal{X}^{(\dim X)}$ together with the weight function (on the codimension 1 cells in \mathcal{X})

$$\omega_{\varphi \cdot \mathcal{X}}(\tau) := \sum_{\sigma \in \mathcal{X}: \sigma > \tau} \omega_{\mathcal{X}}(\sigma) \cdot \varphi_\sigma(v_{\sigma/\tau}) - \varphi_\tau \left(\sum_{\sigma \in \mathcal{X}: \sigma > \tau} \omega_{\mathcal{X}}(\sigma) \cdot v_{\sigma/\tau} \right).$$

It was shown in [AR10, proposition 3.7] and [Rau09, proposition 1.2.13] that $\varphi \cdot \mathcal{X}$ is balanced; we denote the associated cycle by $\varphi \cdot X \in Z_{\dim X - 1}(X)$. Note that $\varphi \cdot X$ does not depend on the choices of the polyhedral structure of X (use the argument of remark 1.1.13) and representatives of primitive normal vectors $v_{\sigma/\tau}$.

Remark 1.2.3. Let φ be a rational function which is affine linear on the cells of the polyhedral structure \mathcal{X} of X . Then the graph $\tilde{\Gamma}_{\varphi, \mathcal{X}} := \{\tilde{\sigma} : \sigma \in \mathcal{X}\}$, with $\tilde{\sigma} := \{(x, \varphi(x)) : x \in \sigma\}$ and inherited weights, is a weighted polyhedral complex in $V \times \mathbb{R}$. In general, $\tilde{\Gamma}_{\varphi, \mathcal{X}}$ is not balanced at codimension 1 cells $\tilde{\tau}$. It was shown in [AR10, construction 3.3, proposition 3.7] and [Rau09, construction 1.2.5, proposition 1.2.13] that the graph of φ can be made balanced by adding cells of the form $\tilde{\tau} + (\{0\} \times \mathbb{R}_{\leq 0})$ (with $\tau \in \mathcal{X} \setminus \mathcal{X}^{(\dim X)}$) and assigning the new top-dimensional cells the weights $\omega(\tilde{\tau}) := \omega_{\varphi \cdot \mathcal{X}}(\tau)$. The intersection product $\varphi \cdot \mathcal{X}$ can thus be seen as the intersection of (the closure of) the completed graph of φ with the hyperplane at infinity $V \times \{-\infty\}$. This coincides with the classical (that is

algebraic-geometric) idea that the intersection with a rational function describes its zeroes and poles because $-\infty$ is the tropical zero and cells of negative weights can be interpreted as poles.

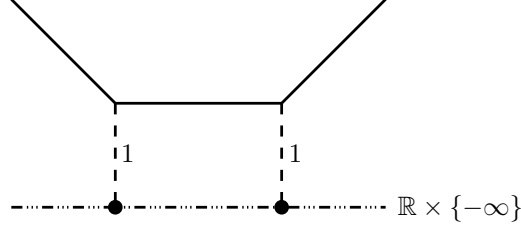

Completed graph of $\max\{-x, x, 1\}$ and its intersection with $\mathbb{R} \times \{-\infty\}$.

Remark 1.2.4. It is easy to see that intersections with rational functions have the following properties:

- The restriction of a rational function φ on X to a subcycle Y is a rational function on Y . Therefore, we can define $\varphi \cdot Y := \varphi|_Y \cdot Y$.
- If φ is an affine linear function, then $\varphi \cdot X = 0$.
- We denote by $|\varphi|$ the domain of non-linearity of the rational function φ (which means that $|\varphi|$ is the set of points $x \in |X|$ around which φ is not affine linear). Then we have $|\varphi \cdot X| \subseteq |\varphi|$.
- Definition 1.2.2 gives rise to a multilinear intersection product

$$\begin{aligned} \mathbb{R}(X) \times \dots \times \mathbb{R}(X) \times Z_k(X) &\rightarrow Z_{k-p}(X), \\ (\varphi_1, \dots, \varphi_p, C) &\mapsto \varphi_1 \cdots \varphi_p \cdot C. \end{aligned}$$

- If X is fan cycle and $\varphi \in \mathbb{R}^{\text{fan}}(X)$, then $\varphi \cdot X$ is a fan cycle.

Remark 1.2.5. The intersection product of a rational function with a tropical cycle is again a well-defined cycle. This is an important difference to the classical case where intersection products are only defined on cycle classes modulo rational equivalence. Another distinction is that tropical rational functions can always be restricted to subcycles which will prove useful to compute self-intersections.

Example 1.2.6. Consider the rational function $\varphi = \max\{x_1, \dots, x_n, 0\}$ on \mathbb{R}^n . In order to compute the intersection product $\varphi \cdot L_k^n$ we first notice that φ is linear on the cones of \mathcal{L}_k^n . For a subset $I \subsetneq \{0, 1, \dots, n\}$ with $|I| = k - 1$ we obtain by example 1.1.9 and definition 1.2.2 that

$$\begin{aligned} \omega_{\varphi \cdot \mathcal{L}_k^n}(\sigma_I) &= \sum_{i \notin I} \varphi_{\sigma_{I \cup \{i\}}}(-e_i) - \varphi_{\sigma_I} \left(\sum_{i \notin I} -e_i \right) \\ &= \sum_{i \notin I} \varphi(-e_i) + \sum_{i \in I} \varphi(-e_i) \\ &= \varphi(-e_0) = 1. \end{aligned}$$

This means that $\varphi \cdot L_k^n = L_{k-1}^n$ and $L_k^n = \max\{x_1, \dots, x_n, 0\}^{n-k} \cdot \mathbb{R}^n$.

Example 1.2.7. Let φ be a rational function on a cycle X which is affine linear on the cells of the polyhedral structure \mathcal{X} of X . We saw in remark 1.2.3 that the completed graph $\Gamma_{\varphi, \mathcal{X}}$ of φ is a balanced polyhedral complex in $V \times \mathbb{R}$. Its associated cycle (which does not depend on the chosen polyhedral structure of X) is denoted by $\Gamma_{\varphi, X}$ and called the modification of X along φ . (Sometimes one is only interested in the codimension 1 cycle along which the modification is performed, rather than in the actual function. In that case, one speaks of the modification of X along the cycle $\varphi \cdot X$, although this is not quite well-defined.) Modifications which have been introduced in [Mik06, section 3.3] often

inherit some properties of their underlying cycle (see for example [All10, theorems 4.2.5 and 4.2.6]). We claim that modifications can be expressed as

$$\Gamma_{\varphi, X} = \max\{\varphi \circ \pi, y\} \cdot X \times \mathbb{R},$$

where $\pi : X \times \mathbb{R} \rightarrow X$ is the projection to X and y is the \mathbb{R} -coordinate in $X \times \mathbb{R}$. To see this, we first notice that $\max\{\varphi \circ \pi, y\}$ is affine linear on the cells of the polyhedral structure

$$\mathcal{Z} := \{\tilde{\sigma} + (\{0\} \times \mathbb{R}_{\geq 0}) : \sigma \in \mathcal{X}\} \cup \{\tilde{\sigma} + (\{0\} \times \mathbb{R}_{\leq 0}) : \sigma \in \mathcal{X}\} \cup \{\tilde{\sigma} : \sigma \in \mathcal{X}\}$$

of $X \times \mathbb{R}$, where $\tilde{\sigma} = (\text{id} \times \varphi)(\sigma)$ was defined in remark 1.2.3. There are two kinds of codimension 1 cells in \mathcal{Z} whose weights we want to compute:

- If $\sigma \in \mathcal{X}^{(\dim X)}$, then the facets in \mathcal{Z} adjacent to $\tilde{\sigma}$ are $\tilde{\sigma} + (\{0\} \times \mathbb{R}_{\geq 0})$ and $\tilde{\sigma} + (\{0\} \times \mathbb{R}_{\leq 0})$ with respective (representatives of) primitive normal vectors $(p, \varphi(p) + 1)$ and $(p, \varphi(p) - 1)$, where p is a point in σ . It follows that the weight of $\tilde{\sigma}$ in $\max\{\varphi \circ \pi, y\} \cdot \mathcal{Z}$ is 1.
- If $\tau \in \mathcal{X}^{(\dim X - 1)}$, then π induces one-to-one correspondences between the facets in \mathcal{Z} adjacent to $\tilde{\tau} + (\{0\} \times \mathbb{R}_{\geq 0})$ resp. $\tilde{\tau} + (\{0\} \times \mathbb{R}_{\leq 0})$ and the facets in \mathcal{X} adjacent to τ , as well as between their primitive normal vectors. Since $\max\{\varphi \circ \pi, y\}$ is equal to the linear function y on each facet around $\tilde{\tau} + (\{0\} \times \mathbb{R}_{\geq 0})$, and equal to the rational function $\varphi \circ \pi$ on each facet adjacent to $\tilde{\tau} + (\{0\} \times \mathbb{R}_{\leq 0})$, we can conclude that

$$\omega_{\max\{\varphi \circ \pi, y\} \cdot \mathcal{Z}}(\tilde{\tau} + (\{0\} \times \mathbb{R}_{\geq 0})) = 0,$$

as well as

$$\omega_{\max\{\varphi \circ \pi, y\} \cdot \mathcal{Z}}(\tilde{\tau} + (\{0\} \times \mathbb{R}_{\leq 0})) = \omega_{\varphi \cdot \mathcal{X}}(\tau).$$

Definition and Construction 1.2.8. Let φ be a rational function on a cycle X and let \mathcal{X} be a polyhedral structure such that φ is affine linear on every cell of \mathcal{X} . For a cell $\tau \in \mathcal{X}$ we choose an affine linear function l on X such that $(\varphi - l)|_{\tau} = 0$. Then $\varphi^{\tau} \in \mathbb{R}^{\text{fan}}(\text{Star}_X(\tau))$ is the rational fan function on $\text{Star}_X(\tau)$ induced by $\varphi - l$ (see [Rau09, section 1.2.3] for more details). Note that in fact φ^{τ} depends on the chosen affine linear function l and is thus only defined up to adding a linear function; however this does not affect intersection products with φ^{τ} (cf. remark 1.2.4). If $\tau = p$ is a point, then φ^p can be obtained by restricting φ to a small neighbourhood of p , composing it with the translation by $-p$, normalising (such that 0 maps to 0) and finally extending it linearly to $\text{Star}_X(p)$.

Proposition 1.2.9. *Let φ, ψ be rational functions on a cycle X . Let \mathcal{X} be a polyhedral structure of X such that φ is affine linear on every cell of \mathcal{X} . Then the following properties hold:*

- $\text{Star}_{\varphi \cdot X}(\tau) = \varphi^{\tau} \cdot \text{Star}_X(\tau)$,
- $\varphi \cdot (\psi \cdot X) = \psi \cdot (\varphi \cdot X)$.

PROOF. The first property has been proved in [Rau09, proposition 1.2.12] and used to reduce the second statement to the case of two-dimensional fan cycles X . The commutativity was then showed in [Rau09, proposition 1.2.13] and [AR10, proposition 3.7]. \square

We have seen in remark 1.2.4 that the support of $\varphi \cdot X$ is contained in the domain of non-linearity of φ . The following example illustrates that it is not an equality in general.

Example 1.2.10. Let \mathcal{X} be the balanced fan in \mathbb{R}^2 consisting of cones $\langle \pm e_i \rangle$ (all of them having weight 1), where e_1, e_2 forms the standard basis of \mathbb{R}^2 . Let φ be the function which is linear on the cones of \mathcal{X} and satisfies $\varphi(e_1) = 1, \varphi(e_2) = -1, \varphi(-e_i) = 0$. Then the weight of the origin in $\varphi \cdot \mathcal{X}$ is 0; thus we see that $|\varphi \cdot \mathcal{X}| = \emptyset \subsetneq \{0\} = |\varphi|$.

The following proposition gives two sufficient conditions for equality.

Proposition 1.2.11 ([Rau09, lemmas 1.2.25 and 1.2.31]). *Let φ be a rational function on a tropical cycle X . Then the following hold:*

- *If φ is convex (i.e. it is locally the restriction of a convex function on V) and X is a tropical variety (i.e. has only non-negative weights), then $|\varphi \cdot X| = |\varphi|$, and $\varphi \cdot X$ has only non-negative weights.*
- *If X is locally irreducible, then $|\varphi \cdot X| = |\varphi|$.*

Remark 1.2.12. Example 1.2.10 shows that in general the assignment

$$\mathbb{R}(X)/L(X) \rightarrow Z_{\dim X-1}(X), \quad \bar{\varphi} \mapsto \varphi \cdot X,$$

where $L(X)$ denotes the group of affine linear functions on X , is not injective. The easiest example of the assignment not being surjective is the example of a point (with weight 1) in the cycle $X = 2 \cdot \mathbb{R}$ (i.e. the cycle \mathbb{R} with weight 2). An example which cannot be fixed by allowing rational slopes is $(\mathbb{R} \cdot e_1) \times \{0\}$ in the cycle $(\mathbb{R} \cdot e_1 + \mathbb{R} \cdot e_2) \times \mathbb{R}$, where $\{e_1, e_2\}$ is the standard basis of \mathbb{R}^2 and the sum is a sum of tropical cycles.

We use proposition 1.2.11 to prove a lemma that will be useful in later sections.

Lemma 1.2.13. *Let x_1, \dots, x_n be a basis of the dual lattice Λ^\vee . If X is a non-zero tropical fan variety in V , then $\max\{x_1, \dots, x_n, 0\} \cdot X$ is again a non-zero tropical fan variety.*

PROOF. As $\max\{x_1, \dots, x_n, 0\}$ is convex we know by proposition 1.2.11 that the intersection product $\max\{x_1, \dots, x_n, 0\} \cdot X$ is a tropical fan variety whose support is the domain of non-linearity $|\max\{x_1, \dots, x_n, 0\}|_X$. The balancing condition and the positivity of the weights of X imply that X cannot be fully contained in a cone of \mathcal{L}_n^n . This allows us to conclude that $|\max\{x_1, \dots, x_n, 0\}|_X$ contains the origin and is thus not empty. Therefore, $\max\{x_1, \dots, x_n, 0\} \cdot X$ is not the zero cycle. □

We now give the definition of the pull-back of a rational function along a morphism.

Definition 1.2.14. Let $f : X \rightarrow Y$ be a morphism of tropical cycles and let φ be a rational function on Y . Then the pull-back of φ along f is the rational function $f^*\varphi := \varphi \circ f \in \mathbb{R}(X)$. Note that if φ is affine linear on the cells of the polyhedral structure \mathcal{Y} , and \mathcal{X}, \mathcal{Y} are compatible with respect to f , then $f^*\varphi$ is affine linear on the cells of \mathcal{X} . The pull-back of a rational fan function along a linear morphism of fan cycles is again a rational fan function.

Lemma 1.2.15 ([AR10, lemma 9.6], [Rau09, lemma 1.5.4]). *Let X, X' be tropical cycles in V, V' . Let φ be a rational function on X and $\pi : V \times V' \rightarrow V$ the projection to the first factor. Then we have*

$$(\varphi \cdot X) \times X' = \pi^*\varphi \cdot (X \times X').$$

The projection formula connects the notions of push-forward and pull-back and is an extremely valuable tool for computations.

Proposition 1.2.16 ([AR10, proposition 4.8], [Rau09, theorem 1.3.11]). *Let $f : X \rightarrow Y$ be a morphism of tropical cycles. Let C be a subcycle of X and let φ be a rational function on Y . Then the following equation holds in $Z_{\dim C-1}(Y)$:*

$$\varphi \cdot f_*C = f_*(f^*\varphi \cdot C).$$

Remark 1.2.17. One can define a Cartier divisor on a tropical cycle X to be an open cover $\{U_i\}$ of X together with rational functions φ_i on the open sets U_i whose differences $\varphi_i - \varphi_j$ are (locally) affine linear functions on the overlaps $U_i \cap U_j$. By gluing together the

local intersection products (which are defined as in definition 1.2.2), one obtains a well-defined codimension 1 subcycle of X – the associated Weil divisor. The affine linearity condition on the overlaps ensures that the associated Weil divisor does not depend on any choices. As this intersection product is local, proposition 1.2.11 and the projection formula immediately extend to Cartier divisors. We will introduce a more general construction in the next chapter, so we will not give more details here; instead we refer to [AR10, section 6] and [Rau09, section 1.2.5] where Cartier divisors are discussed in great detail.

1.3. Intersecting cycles in vector spaces

We summarise the construction of an intersection product of tropical cycles in vector spaces in this section. This was presented in [AR10, section 9] and is based on the idea to intersect the the cross product of the cycles, whose intersection product one wants to compute, with rational functions that cut out the diagonal of the vector space.

Definition 1.3.1. The diagonal Δ_X of a tropical cycle X is the push-forward

$$\Delta_X := d_* X \in Z_{\dim X}(X \times X)$$

along the morphism $d : X \rightarrow X \times X$, $x \mapsto (x, x)$.

Notation 1.3.2. For a vector space $V = \Lambda \otimes_{\mathbb{Z}} \mathbb{R}$ of dimension n we fix a basis x_1, \dots, x_n of the dual lattice Λ^\vee . When we consider the product $V \times V$, in order to differentiate between the two factors, we denote the coordinate functions of the first factor V by x_i and the coordinate functions of the second factor by y_i .

Lemma 1.3.3. *The diagonal of the vector space V can be cut out by the rational functions $\max\{x_i, y_i\}$, which means that*

$$\Delta_V = \max\{x_1, y_1\} \cdots \max\{x_n, y_n\} \cdot V \times V.$$

Furthermore, $\max\{x_1, y_1\} \cdots \max\{x_n, y_n\} \cdot X \times Y$ is a subcycle of the diagonal Δ_V for any cycles X, Y in V .

PROOF. The first statement is obvious for $n = 1$; for greater n it follows by induction using lemma 1.2.15. We see by remark 1.2.4 that

$$|\max\{x_1, y_1\} \cdots \max\{x_n, y_n\} \cdot X \times Y| \subseteq |\max\{x_1, y_1\} \cap \dots \cap \max\{x_n, y_n\}| = |\Delta_V|,$$

which implies the second claim. \square

Definition 1.3.4. Let $\pi : V \times V \rightarrow V$ be the projection to the first factor. The intersection product of two cycles $X \in Z_{n-r}(V)$ and $Y \in Z_{n-s}(V)$ in the n -dimensional ambient space V is defined to be

$$X \cdot Y := \pi_*(\max\{x_1, y_1\} \cdots \max\{x_n, y_n\} \cdot X \times Y) \in Z_{n-r-s}(V).$$

Remark 1.3.5. We can immediately conclude that the intersection product of cycles has the following properties:

- It follows by lemma 1.3.3 that the definition of the intersection product does not depend on the chosen projection (i.e. we could as well project to the second factor). As the rational functions $\max\{x_i, y_i\}$ are symmetric, this implies that the intersection product is commutative, i.e.

$$X \cdot Y = Y \cdot X.$$

- Lemma 1.3.3 also implies that

$$|X \cdot Y| \subseteq \pi(|X \times Y| \cap |\Delta_V|) = |X| \cap |Y|.$$

- Definition 1.3.4 gives a bilinear intersection product

$$Z_{n-r}(V) \times Z_{n-s}(V) \rightarrow Z_{n-r-s}(V), (X, Y) \mapsto X \cdot Y,$$

which can be restricted to the class of fan cycles (that means that the intersection of two fan cycles is again a fan cycle).

- It follows by the projection formula (proposition 1.2.16), proposition 1.2.15 and the commutativity of intersecting with rational functions that

$$\varphi \cdot (X \cdot Y) = (\varphi \cdot X) \cdot Y$$

for every rational function φ on X .

- If \mathcal{X}, \mathcal{Y} are polyhedral structures of X, Y , then $(\mathcal{X} \cap \mathcal{Y})^{(n-\text{codim } X - \text{codim } Y)}$ together with a certain weight function (which might assign weight 0 to some maximal cells) is a polyhedral structure of the intersection product $X \cdot Y$.
- The intersection product of two tropical varieties (i.e. cycles with only non-negative weights) is again a tropical variety. This is an easy consequence of proposition 1.2.11 as the functions $\max\{x_i, y_i\}$ are convex.

Theorem 1.3.6. *Let X, Y, Z be arbitrary cycles of respective codimension r, s, p in V . Then the following hold:*

- The intersection product is associative, i.e. $(X \cdot Y) \cdot Z = X \cdot (Y \cdot Z)$.
- $V \cdot X = X$.
- If there are rational functions φ_i such that $X = \varphi_1 \cdots \varphi_r \cdot V$, then

$$X \cdot Y = \varphi_1 \cdots \varphi_r \cdot Y.$$

- The intersection product is local; this means that for any $\tau \in \mathcal{X} \cap \mathcal{Y}$ of dimension smaller or equal to $n - r - s$ we have

$$\text{Star}_{X \cdot Y}(\tau) = \text{Star}_X(\tau) \cdot \text{Star}_Y(\tau),$$

where \mathcal{X}, \mathcal{Y} are any polyhedral structures of X, Y .

PROOF. This was proved in [Rau09, proposition 1.5.9, proposition 1.5.3, corollary 1.5.6, proposition 1.5.8] as well as in [AR10, theorem 9.10, corollary 9.5, corollary 9.8]. \square

Remark 1.3.7. The third part of the previous theorem implies that we have indeed

$$X \cdot Y = \pi_*(\Delta_V \cdot (X \times Y)),$$

which was the initial idea for the definition of the intersection product. Furthermore, it follows that the intersection product does not depend on the choice of rational functions that cut out the diagonal. In particular, it is independent of the choice of coordinate functions in notation 1.3.2.

Remark 1.3.8. The intersection product of two cycles is again a well-defined cycle, rather than a cycle class modulo rational equivalence as it is in the classical case. Note that this is also true for self-intersections.

We use the intersection product of cycles to define the degree of a cycle in \mathbb{R}^n .

Definition 1.3.9. The degree of a zero-dimensional cycle $C = \sum_{i=1}^m \lambda_i P_i$ in \mathbb{R}^n is defined to be $\deg(C) := \sum_{i=1}^m \lambda_i \in \mathbb{Z}$. The degree of a cycle $C \in Z_k(\mathbb{R}^n)$ is $\deg(C) := \deg(C \cdot L_k^n)$, where L_k^n is the fan cycle of example 1.1.15.

Remark 1.3.10. It follows from theorem 1.3.6 and example 1.2.6 that a k -dimensional subcycle C of \mathbb{R}^n has degree $\deg(\max\{x_1, \dots, x_n, 0\}^k \cdot C)$ and that the fan cycles L_k^n have degree 1. We also know from lemma 1.2.13 that non-zero tropical fan varieties have a positive degree.

Remark 1.3.11. Most of the intersection theory presented so far has been implemented by Simon Hampe in [Ham]. His programme can also graphically display tropical curves and surfaces. In particular, all surfaces that are coloured green in this work have been created using [Ham]. (The grey surfaces have been produced using [All2].)

Next we introduce an alternative (and equivalent) intersection product of tropical fan cycles, which originates from toric intersection theory. Therefore, we need the following notation.

Notation 1.3.12. Tropical subfans (i.e. subfans that fulfil the balancing condition) of a tropical fan \mathcal{X} are called Minkowski weights in \mathcal{X} . We denote by $Z_k(\mathcal{X})$ the additive group of k -dimensional Minkowski weights in \mathcal{X} .

Remark 1.3.13. Let $X \in Z_{n-k}^{\text{fan}}(V)$, $Y \in Z_{n-p}^{\text{fan}}(V)$ be fan cycles in the n -dimensional vector space V . We choose fan structures $\mathcal{X}, \mathcal{Y}, \Delta$ of X, Y, V such that \mathcal{X} and \mathcal{Y} are Minkowski weights in Δ (cf. lemma 1.1.19). We know by [FS97, theorem 2.1] that the Minkowski weights \mathcal{X}, \mathcal{Y} correspond to Chow cohomology classes $\gamma_{\mathcal{X}} \in A^k(X(\Delta))$, $\gamma_{\mathcal{Y}} \in A^p(X(\Delta))$ of the complete toric variety $X(\Delta)$. This is particularly nice as it turns out that the fan displacement rule given in [FS97, proposition 3.1, theorem 3.2] to compute the cup product $\gamma_{\mathcal{X}} \cup \gamma_{\mathcal{Y}} \in A^{k+p}(X(\Delta))$ can also be used to compute the tropical intersection product $X \cdot Y \in Z_{n-k-p}^{\text{fan}}(V)$ of the corresponding tropical cycles (see [Kat12, theorem 4.4] or [Rau09, theorem 1.5.17]). That means that for $\tau \in (\mathcal{X} \cap \mathcal{Y})^{(n-k-p)}$ and a generic vector $v \in V$ we have

$$\omega_{\mathcal{X}, \mathcal{Y}}(\tau) = \sum |\Lambda / \Lambda_{\sigma} + \Lambda_{\sigma'}| \cdot \omega_{\mathcal{X}}(\sigma) \cdot \omega_{\mathcal{Y}}(\sigma'),$$

where the sum runs over all maximal cells $\sigma \in \mathcal{X}, \sigma' \in \mathcal{Y}$ which contain τ and satisfy $\sigma \cap (\sigma' + v) \neq \emptyset$. The underlying tropical idea is to slightly move one of the cycles in order to make the two cycles intersect transversally and then simply read off their intersection product. We refer to [RGST05, section 4], [Mik06, definition 4.4], [Rau09, corollary 1.5.16] for more details.

The following remark states that, under some assumptions, computing intersection products commutes with tropicalisation.

Remark 1.3.14. Let K be the field of Puiseux series (cf. remark 1.1.17) and let X, Y be algebraic varieties in $(K^*)^n$ whose tropicalisations $\text{Trop}(X)$ and $\text{Trop}(Y)$ meet properly, i.e. the intersection of polyhedral structures of $\text{Trop}(X)$ and $\text{Trop}(Y)$ is a polyhedral complex of pure dimension $\dim X + \dim Y - n$. Then [OP, corollary 5.1.2] states that

$$\text{Trop}(X \cdot Y) = \text{Trop}(X) \cdot \text{Trop}(Y),$$

where the right-hand side is an intersection product of tropical varieties in \mathbb{R}^n and the left-hand side is the tropicalisation of the refined intersection cycle $X \cdot Y$ (cf. [Ful98, sections 8.1 and 8.2]). Note that the assumption that the tropicalisations meet properly is really needed: The curves $V(x + y + 1)$ and $V(tx + y + 1)$ do not intersect in $(K^*)^2$. However, their tropicalisations, L_1^2 and the translation of L_1^2 by the vector $(-1, 0)$, intersect set-theoretically in the unbounded line segment $(-\infty, -1] \times \{0\}$ and intersection-theoretically in the point $(-1, 0)$ with multiplicity 1.

1.4. Rational and numerical equivalence

In this section we state the main results about tropical rational equivalence. Although tropical intersection products are well-defined on the level of cycles, it is nevertheless often useful to intersect rationally equivalent cycles in order to simplify the computations. The concept of tropical rational equivalence, which was introduced in [AR10, chapter 8] and

[AR], is especially useful in enumerative geometry where one is usually only interested in the number of objects satisfying given conditions, rather than the actual objects.

Definition 1.4.1. A subcycle C of a cycle X is rationally equivalent to 0 on X if there exist a morphism $f : C' \rightarrow X$ and a bounded rational function φ on C' such that $C = f_*\varphi \cdot C'$. Two subcycles of X are rationally equivalent on X if their difference is rationally equivalent to 0 on X . Note that rational equivalence is clearly reflexive and symmetric; the transitivity follows from gluing together the morphisms $f_i : C'_i \rightarrow X$ as well as the bounded rational functions φ_i to obtain a morphism $C'_1 \dot{\cup} C'_2 \rightarrow X$ and a bounded rational function φ on the disjoint union $C'_1 \dot{\cup} C'_2$. We call $A_d(X) := Z_d(X) / \sim_{\text{rat}}$ the d -dimensional Chow group of X .

Remark 1.4.2. It follows immediately from the definition that two cycles that are rationally equivalent on X are also rationally equivalent on every cycle Y with $X \in Z_{\dim X}(Y)$.

Remark 1.4.3. Definition 1.4.1 is somewhat different from its classical counterpart and therefore requires some explanation: First, the requirement that C is a push-forward $f_*\varphi \cdot C'$ rather than just an intersection product $\varphi \cdot C'$ makes rational equivalence compatible with push-forwards. This adjustment is indeed needed as was demonstrated in [AR10, remark 8.6]. Second, the reason why one requests the rational function φ to be bounded is that one does not want it to have non-zero slope in the boundary of C' . Otherwise, $\varphi \cdot C'$ might have hidden boundary components which our intersection theory does not capture as our tropical cycles are, in general, not compact. For example, $\max\{x, 0\} \cdot \mathbb{R}$ can be regarded to have a hidden simple pole in plus infinity since $\max\{x, 0\}$ approaches this point with slope 1. In the absence of this boundary point, one obviously does not want $\{0\} = \max\{x, 0\} \cdot \mathbb{R}$ to be rationally equivalent to zero on \mathbb{R} . We refer to [Mey10, section 2.3] for a detailed study of intersection theory on compact tropical toric varieties and note that in [Mey10, section 2.4] the definition of rational equivalence on these compact varieties does not require the rational function to be bounded.

Definition 1.4.4. The cycles $C, D \in Z_d(X)$ are numerically equivalent on X if

$$\deg(\varphi_1 \cdots \varphi_d \cdot C) = \deg(\varphi_1 \cdots \varphi_d \cdot D)$$

for all rational functions φ_i on X .

Lemma 1.4.5 ([AR, lemma 2]). *Let C be rationally equivalent to 0 on X . Then the following hold:*

- If φ is a rational function on X , then $\varphi \cdot C$ is rationally equivalent to 0 on X .
- If Y is a cycle, then $C \times Y$ is rationally equivalent to 0 on $X \times Y$.
- If $f : X \rightarrow Y$ is a morphism, then f_*C is rationally equivalent to 0 on Y .
- If $X = V$ and D is a cycle in V , then $C \cdot D$ is rationally equivalent to 0 on V .
- If C is zero-dimensional, then $\deg(C) = 0$.
- If A, B are rationally equivalent on X , then they are also numerically equivalent on X .

Definition 1.4.6. Let σ be a polyhedron in V . Then the recession cone of σ is

$$\text{rc}(\sigma) := \{v \in V : \exists x \in \sigma \text{ such that } x + \mathbb{R}_{\geq 0} \cdot v \subseteq \sigma\}.$$

Let X be a cycle in V and let \mathcal{X} be a polyhedral structure of X such that $\{\text{rc}(\sigma) : \sigma \in \mathcal{X}\}$ is a fan (cf. [Rau09, lemma 1.4.10]). The recession cycle $\delta(X) \in Z_{\dim X}^{\text{fan}}(V)$ of X is the fan cycle associated to the fan $\{\text{rc}(\sigma) : \sigma \in \mathcal{X}\}$ with weight function

$$\omega(\alpha) := \sum_{\sigma \in \mathcal{X} : \text{rc}(\sigma) = \alpha} \omega_{\mathcal{X}}(\sigma).$$

We refer to [Rau09, section 1.4.3] for more details about recession cones and cycles.

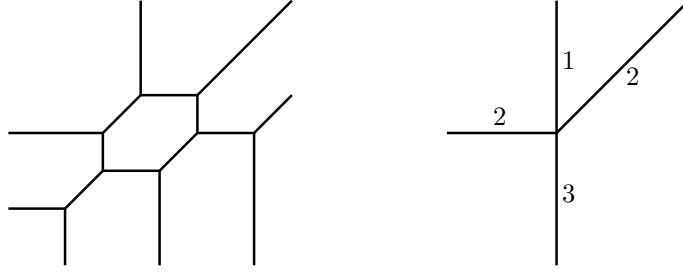

A curve of degree 3 and its recession cycle.

Theorem 1.4.7. *The morphism of groups $Z_d(V) \rightarrow Z_d^{\text{fan}}(V)$, $X \mapsto \delta(X)$ induces an isomorphism $A_d(V) \rightarrow Z_d^{\text{fan}}(V)$. In other words, the recession cycle $\delta(X)$ is the only fan cycle which is rationally equivalent in V to the cycle X . For all cycles X, Y in V , one has $\delta(X \cdot Y) = \delta(X) \cdot \delta(Y)$. Furthermore, two cycles in V are rationally equivalent if and only if they are numerically equivalent.*

PROOF. The first part was proved in [AR, theorems 6 and 7, remark 9]. The second is an immediate consequence of [Rau09, proposition 1.4.15]. \square

Remark 1.4.8. The fact that translating a cycle in V does not change its equivalence class justifies why the fan displacement formula in remark 1.3.13 does not depend on the chosen translation vector.

Remark 1.4.9. It follows from remark 1.3.10 and theorem 1.4.7 that non-zero tropical varieties in \mathbb{R}^n have positive degree.

Proposition 1.4.10 ([All10, proposition 2.2.2]). *Let $X \in Z_{\dim X}^{\text{fan}}(V)$ be a fan cycle. Then every subcycle C of X is numerically equivalent (on X) to its recession cycle $\delta(C)$.*

Piecewise polynomials and tropical cocycles

In this chapter we use piecewise polynomials to define tropical cocycles, generalising the notion of tropical Cartier divisors to higher codimensions. Groups of cocycles are tropical analogues of Chow cohomology groups. We introduce an intersection product of cocycles with tropical cycles – the counterpart of the classical cap product – and prove that this gives rise to a Poincaré duality on vector spaces.

Piecewise polynomials are used in toric geometry to describe equivariant Chow cohomology rings. In [KP08] the authors describe a method to assign a Minkowski weight in a complete fan Δ to a piecewise polynomial on Δ and therefore suggest using piecewise polynomials in tropical geometry. If Δ is unimodular (i.e. corresponds to a smooth toric variety), their assignment is even an isomorphism.

We show that the assignment of [KP08], which describes the canonical map from equivariant to ordinary Chow cohomology rings of the corresponding toric variety, agrees with the (inductive) intersection product of tropical rational functions introduced in definition 1.2.2. This motivates us to use piecewise polynomials as local ingredients for tropical cocycles. It turns out that each piecewise polynomial on an arbitrary tropical fan cycle is a sum of products of rational functions; this can be used to intersect cocycles with tropical cycles. One should note that, in contrast to the classical cap product, our intersection product is well-defined on the level of cycles, not only on classes modulo rational equivalence. We deduce a Poincaré duality on vector spaces from the isomorphism between the groups of piecewise polynomials and Minkowski weights on complete, unimodular fans.

A construction similar to piecewise polynomials on fans has been introduced independently in [Est]: Esterov defines tropical varieties with (degree k) polynomial weights and their (codimension 1) corner loci which are tropical varieties with (degree $k - 1$) polynomial weights.

This chapter mainly consists of the material of my article [Fra].

2.1. Intersecting with piecewise polynomials

In this section we define intersection products of piecewise polynomials with tropical fan cycles using the known intersection products of rational functions and representations of piecewise polynomials as sums of products of rational functions. This intersection product agrees with the intersection product of [KP08] emerging from toric geometry and inherits the expected properties from the intersection product with rational functions.

In order to fix our notation we start by recalling the definition of a piecewise polynomial on a (not necessarily tropical) fan F .

Definition 2.1.1. Let σ be a (rational) cone in the vector space $V = \Lambda \otimes_{\mathbb{Z}} \mathbb{R}$ corresponding to a lattice Λ . We define $P^k(\sigma)$ to be the set of functions $g : \sigma \rightarrow \mathbb{R}$ that extend to a homogeneous polynomial of degree k on the subspace V_σ having integer coefficients (that means $g \in \text{Sym}^k(\Lambda_\sigma^\vee)$ – the degree k part of the symmetric algebra $\text{Sym}(\Lambda_\sigma^\vee)$). A piecewise polynomial of degree k on a (rational) fan F in V is a continuous function

$h : |F| \rightarrow \mathbb{R}$ on the support of F such that the restriction $h|_{\sigma} \in P^k(\sigma)$ for each cone $\sigma \in F$. The sum of two degree k piecewise polynomials h, h' on F is defined pointwise, i.e. $(h + h')(x) := h(x) + h'(x)$. As the $P^k(\sigma)$ are additive groups, the sum $h + h'$ is again a piecewise polynomial on F . The (additive) group of piecewise polynomials of degree k on the fan F is denoted by $PP^k(F)$. Since products of homogeneous integer polynomials are again homogeneous integer polynomials, the pointwise multiplication of two piecewise polynomials $h \in PP^k(F), h' \in PP^l(F)$ is in $PP^{k+l}(F)$. We call $PP^*(F) := \bigoplus_{k \in \mathbb{N}} PP^k(F)$ the graded ring of piecewise polynomials on F . Finally, we define $LPP^{k-1}(F) := \langle \{l \cdot h : l \text{ linear}, h \in PP^{k-1}(F)\} \rangle$ to be the subgroup of $PP^k(F)$ generated by linear functions.

Remark 2.1.2. Note that piecewise polynomials of degree 1 are the same as rational fan functions and that restrictions of piecewise polynomials to subfans are again piecewise polynomials (of the same degree).

We are ready to state the above-mentioned result of Katz and Payne, which was proved in chapter 1, proposition 1.2, theorem 1.4 of [KP08].

Definition and Theorem 2.1.3. Let Δ be a complete, unimodular (i.e. every cone is generated by a part of a lattice basis) fan in the n -dimensional vector space V . If $\{v_1, \dots, v_n\}$ is a basis of Δ , then we can regard the elements v_1^*, \dots, v_n^* of its dual basis as integer linear functions on V , which means $v_i^* \in P^1(V)$. For two cones $\tau < \sigma \in \Delta^{(n)}$, with σ generated by v_1, \dots, v_n , one can thus define $e_{\sigma, \tau} := \prod_{i: v_i \notin \tau} \frac{1}{v_i^*}$ to be the inverse of the product $\prod_{v_i \notin \tau} v_i^* \in P^{n-\dim(\tau)}(V)$. Let $1 \leq k \leq n$ and $h \in PP^k(\Delta)$. For a maximal cone $\sigma \in \Delta$, h_{σ} denotes the polynomial on V that agrees with h on σ . Then for any $\tau \in \Delta^{(n-k)}$

$$c_{h, \Delta}(\tau) := \sum_{\sigma \in \Delta^{(n)}: \sigma > \tau} e_{\sigma, \tau} h_{\sigma}$$

is an integer. Furthermore,

$$h \cdot \Delta := \left(\Delta^{(\leq n-k)}, c_{h, \Delta} \right)$$

is a tropical fan, and the assignment

$$PP^k(\Delta) / LPP^{k-1}(\Delta) \rightarrow Z_{n-k}(\Delta), \quad h \mapsto h \cdot \Delta$$

is an isomorphism of groups. The fan cycle associated to $h \cdot \Delta$ is independent under refinement of Δ and is denoted by $h \cdot V$.

Remark 2.1.4. All previous notions have counterparts in toric intersection theory: As we have already mentioned in remark 1.3.13, [FS97, theorem 2.1] states that for any complete n -dimensional fan Δ , the groups $Z_{n-k}(\Delta)$ of Minkowski weights are canonically isomorphic to (ordinary) Chow cohomology groups $A^k(X(\Delta))$ of the complete toric variety $X(\Delta)$. Furthermore, groups of piecewise polynomials $PP^k(F)$ on any fan F are canonically isomorphic to equivariant Chow cohomology groups $A_T^k(X(F))$ of the associated toric variety $X(F)$ [Pay06, theorem 1]. Katz and Payne showed in [KP08, theorem 1.4] that, under these identifications, the canonical map $A_T^k(X(\Delta)) \rightarrow A^k(X(\Delta))$ is given by intersections with piecewise polynomials $h \mapsto h \cdot \Delta$.

Example 2.1.5. Let $\{e_1, e_2\}$ be the standard basis of \mathbb{R}^2 and let Δ be the complete fan with maximal cones $\langle -e_1, e_1 + e_2 \rangle, \langle -e_2, e_1 + e_2 \rangle$ and $\langle -e_1, -e_2 \rangle$. We write $x := e_1^*$, $y := e_2^*$ and see that the dual bases are given by $\{y, y - x\}, \{x, x - y\}$ and $\{-x, -y\}$ respectively. Let $h \in PP^2(\Delta)$ be the piecewise polynomial shown in the picture.

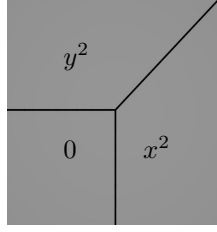

Then $h \cdot \Delta$ is the origin with weight

$$c_{h \cdot \Delta}(\{0\}) = \frac{y^2}{y(y-x)} + \frac{x^2}{x(x-y)} + \frac{0}{(-x)(-y)} = \frac{-xy^2 + yx^2}{xy(x-y)} = 1.$$

Note that $h = (\max\{x, y, 0\})^2 = \max\{x, y\} \cdot \max\{x, y, 0\}$ is a product of rational functions and that $\max\{x, y, 0\} \cdot \max\{x, y, 0\} \cdot \Delta$ and $\max\{x, y\} \cdot \max\{x, y, 0\} \cdot \Delta$ (as product of rational functions with cycles defined in the previous section) give the origin with weight 1 too.

If a piecewise polynomial on a complete fan Δ is a product of rational (i.e. piecewise linear) functions φ_i , then there are two ways of defining its intersection product with Δ : we can either intersect inductively with the rational functions φ_i or use the formula of theorem 2.1.3. In the previous example both ways led to the same result. We show in the following proposition that this is true in general:

Proposition 2.1.6. *Let Δ be a complete, unimodular fan in V , and let $\varphi_1, \dots, \varphi_k$ be rational functions on V which are linear on every cone of Δ . Let $h = \varphi_1 \cdots \varphi_k \in \text{PP}^k(\Delta)$. Then $h \cdot V = \varphi_1 \cdots \varphi_k \cdot V$, where the products on the right-hand side are products of rational functions with cycles (cf. definition 1.2.2).*

In order to prove this proposition we need the following lemma.

Lemma 2.1.7. *Let φ be a rational fan function on a fan cycle X which is linear on the cones of the unimodular fan structure \mathcal{X} of X . For a ray r of \mathcal{X} with primitive integral vector v_r , let Ψ_r be the function which is linear on the cones of \mathcal{X} , satisfies $\Psi_r(v_r) = 1$, and maps the primitive integral vectors of all other rays of \mathcal{X} to 0. Then $\varphi = \sum_{r \in \mathcal{X}(1)} \varphi(v_r) \cdot \Psi_r$.*

PROOF. As φ and $\sum_{r \in \mathcal{X}(1)} \varphi(v_r) \cdot \Psi_r$ are both linear on the cones of \mathcal{X} it suffices to compare their values on the primitive integral vectors of the rays of \mathcal{X} where they agree by construction. \square

PROOF OF PROPOSITION 2.1.6. Let $\tau \in \Delta^{(n-k)}$ be an arbitrary codimension k cone in Δ . By adding an appropriate linear function l , we can assume that the restriction $\varphi_1|_{\tau}$ is identically zero. This does not change $h \cdot V$ since $l \cdot \varphi_2 \cdots \varphi_k$ is in $\text{LPP}^{k-1}(\Delta)$. In the following r, r_i denote rays of Δ with respective primitive integral vector v, v_i . If $\alpha < \sigma$ are cones in the unimodular fan Δ , then σ is the Minkowski sum of α and the $\dim(\sigma) - \dim(\alpha)$ rays of σ that are not in α . We first assume that $k = 1$. The fact that $\varphi_1|_{\tau} = 0$ implies that

$$\omega_{\varphi_1 \cdot \Delta}(\tau) = \sum_{r: \tau+r \in \Delta^{(n)}} \varphi_1(v) = \sum_{r: \tau+r \in \Delta^{(n)}} \frac{1}{v^*} (\varphi_1)_{\tau+r} = c_{\varphi_1 \cdot \Delta}(\tau),$$

where the sums run over Minkowski sums $\tau + r$. Here the middle equality follows from lemma 2.1.7 and the facts that $\varphi_1|_{\tau} = 0$ and $(\Psi_r)_{\tau+r} = v^*$.

Now we assume that $k > 1$ and set $g := \varphi_2 \cdots \varphi_k$. As $\varphi_1|_{\tau} = 0$ the definition of

intersecting with a rational function implies that τ has weight

$$\omega_{\varphi_1 \cdots \varphi_k \cdot \Delta}(\tau) = \sum_{r: \tau+r \in \Delta^{(n-k+1)}} \omega_{\varphi_2 \cdots \varphi_k \cdot \Delta}(\tau+r) \cdot \varphi_1(v)$$

in $\varphi_1 \cdots \varphi_k \cdot \Delta$. By induction on the degree of f this is equal to

$$\begin{aligned} & \sum_{r: \tau+r \in \Delta^{(n-k+1)}} c_{(\varphi_2 \cdots \varphi_k) \cdot \Delta}(\tau+r) \cdot \varphi_1(v) \\ &= \sum_{r: \tau+r \in \Delta^{(n-k+1)}} \sum_{\sigma \in \Delta^{(n)}: \sigma > \tau+r} e_{\sigma, \tau+r} \cdot g_{\sigma} \cdot \varphi_1(v) \\ &= \sum_{\substack{\sigma > \tau \text{ in } \Delta^{(n)} \\ \sigma = \tau + r_1 + \dots + r_k}} \sum_{i=1}^k \varphi_1(v_i) \cdot e_{\sigma, \tau+r_i} \cdot g_{\sigma} \\ &= \sum_{\substack{\sigma > \tau \text{ in } \Delta^{(n)} \\ \sigma = \tau + r_1 + \dots + r_k}} \sum_{i=1}^k \varphi_1(v_i) \cdot v_i^* \cdot e_{\sigma, \tau} \cdot g_{\sigma} \\ &= \sum_{\substack{\sigma > \tau \text{ in } \Delta^{(n)} \\ \sigma = \tau + r_1 + \dots + r_k}} e_{\sigma, \tau} \cdot \left(g \cdot \sum_{i=1}^k \varphi_1(v_i) v_i^* \right)_{\sigma}. \end{aligned}$$

As in the induction start, we use $\varphi_1|_{\tau} = 0$ to conclude that the above agrees with

$$\sum_{\substack{\sigma > \tau \text{ in } \Delta^{(n)} \\ \sigma = \tau + r_1 + \dots + r_k}} e_{\sigma, \tau} \cdot (g \cdot \varphi_1)_{\sigma} = c_{h \cdot \Delta}(\tau).$$

□

Remark 2.1.8. There is an alternative way of deducing the $k > 1$ case of proposition 2.1.6 from the $k = 1$ case: As the canonical map $A_T^*(X(\Delta)) \rightarrow A^*(X(\Delta))$ is a ring homomorphism it follows from remark 2.1.4 that

$$(\varphi_1 \cdots \varphi_k) \cdot \Delta = (\varphi_1 \cdot \Delta) \cup \dots \cup (\varphi_k \cdot \Delta),$$

where the cup products on the right-hand side are computed using the fan displacement rule (cf. remark 1.3.13). As the cup product of Minkowski weights agrees with the intersection product of tropical cycles, theorem 1.3.6 implies that the above is equal to $\varphi_1 \cdots \varphi_k \cdot \Delta$ (interpreted as an inductive intersection product with rational functions).

So far vector spaces are the only fan cycles admitting an intersection product with piecewise polynomials (cf. theorem 2.1.3). Therefore, our next aim is to define an intersection product for arbitrary fan cycles. The idea is to write piecewise polynomials as sums of products of rational fan functions and use these representations to define an intersection product. We introduce some more notation:

Notation 2.1.9. The group of piecewise polynomials of degree k on a fan cycle X is defined to be $\text{PP}^k(X) := \{h : h \in \text{PP}^k(\mathcal{X}) \text{ for some fan structure } \mathcal{X} \text{ of } X\}$. Note that sums and products of piecewise polynomials h, h' on X are computed as in definition 2.1.1 using a fan structure of X on whose cones both h and h' are polynomials. We set $\text{LPP}^{k-1}(X) := \langle \{l \cdot h : l \text{ linear}, h \in \text{PP}^{k-1}(X)\} \rangle$.

Notation 2.1.10. Let F be a unimodular fan and let v_1, \dots, v_m be the primitive integral vectors of the rays r_1, \dots, r_m of F . Then $\Psi_{r_i} := \Psi_{v_i} := \Psi_i \in \text{PP}^1(F)$ is the unique function that is linear on the cones of F and satisfies $\Psi_i(v_j) = \delta_{ij}$, where δ_{ij} is the Kronecker delta function. For a cone $\tau \in F$ we have a piecewise polynomial $\Psi_{\tau} := \prod_{i: v_i \in \tau} \Psi_i \in \text{PP}^{\dim \tau}(F)$. Note that Ψ_{τ} vanishes away from $\bigcup_{\sigma > \tau} \sigma$.

Remark 2.1.11. Note that $e_{\sigma,\tau} = (\Psi_\tau)_\sigma / (\Psi_\sigma)_\sigma$, where $(\Psi_\tau)_\sigma$ denotes the polynomial that agrees with the piecewise polynomial Ψ_τ on the cone σ .

As mentioned in [Bri96], one can show that the functions Ψ_τ generate the ring of piecewise polynomials:

Proposition 2.1.12. *Let $h \in \text{PP}^k(F)$ be a piecewise polynomial of degree k on a unimodular fan F . Then there exists a representation $h = \sum_{\sigma \in F^{(\leq k)}} a_\sigma \Psi_\sigma$, where the a_σ are homogeneous integer polynomials of degree $k - \dim(\sigma)$ and the sum runs over all cones of F of dimension at most k . In particular, piecewise polynomials on tropical fan cycles are sums of products of rational functions.*

PROOF. We use induction on the dimension of F , the case $\dim F = 0$ being obvious. We know by the induction hypothesis that there are homogeneous integer polynomials a_σ such that $h|_{|F_1|} = \sum_{\sigma \in F_1^{(\leq k)}} a_\sigma \Psi_\sigma$, where $F_1 := \{\sigma : \sigma \in F^{(p)} \text{ with } p < \dim F\}$. Thus, it suffices to show the claim for $g := h - \sum_{\sigma \in F_1^{(\leq k)}} a_\sigma \Psi_\sigma \in \text{PP}^k(F)$. Now we use induction on the number r of maximal cones in F . Let $r = 1$ and σ be the unique maximal cone in F . By [Bri96, section 1.2], we know that the following sequence is exact:

$$0 \rightarrow \Psi_\sigma \text{P}^{k-\dim F}(F) \hookrightarrow \text{PP}^k(F) \xrightarrow{\text{rest.}} \text{PP}^k(F \setminus \{\sigma\}) \rightarrow 0.$$

Here $\text{P}^{k-\dim F}(F)$ denotes the group of homogeneous integer polynomials of degree $k - \dim F$ on F . Since $g|_{|F \setminus \{\sigma\}|} = g|_{|F_1|} = 0$, it follows that there is a polynomial a_σ such that $g = a_\sigma \Psi_\sigma$. Now let $r > 1$ and $\sigma \in F$ be a maximal cone. By the induction hypothesis, there are polynomials b_τ such that $g|_{|F \setminus \{\sigma\}|} = \sum_{\tau \in F \setminus \{\sigma\}^{(\leq k)}} b_\tau \Psi_\tau$. Since the restriction of $g - \sum_{\tau \in F \setminus \{\sigma\}^{(\leq k)}} b_\tau \Psi_\tau$ to $F \setminus \{\sigma\}$ is 0, the claim follows from the exactness of the above sequence. It remains to prove the ‘‘in particular’’ statement. Let $h' \in \text{PP}^k(X)$ be a piecewise polynomial on a fan cycle X . We choose a fan structure \mathcal{X} of X such that $h' \in \text{PP}^k(\mathcal{X})$ and refine it to a unimodular fan structure \mathcal{X}' (cf. [Ful93, section 2.6]). Now we apply the first part of the proposition to $h' \in \text{PP}^k(\mathcal{X}')$; as the Ψ_σ are products of rational functions and the homogeneous integer polynomials a_σ are sums of products of linear functions, it follows that h' is a sum of products of rational functions. \square

Before we use the previous proposition to construct an intersection product for any tropical fan cycle, we give an interpretation of the intersection product of Ψ_α with a complete fan in terms of toric intersection theory.

Remark 2.1.13. Let Δ be a complete, unimodular fan in an n -dimensional vector space and let $\alpha \in \Delta$ be a cone of dimension k . Then the weight of a cone $\tau \in \Delta^{(n-k)}$ in the intersection product $\Psi_\alpha \cdot \Delta$ is

$$c_{\Psi_\alpha \cdot \Delta}(\tau) = \deg(V(\alpha) \cdot V(\tau)), \quad (2.1)$$

where the right-hand side is the degree of the intersection product of the orbit closures $V(\alpha)$ and $V(\tau)$ in the smooth, complete toric variety $X(\Delta)$. To prove this, we first recall that $(\Psi_\alpha)_\sigma$ is zero if α is not a face of the maximal cone σ . If α and τ span a maximal cone in Δ , then

$$c_{\Psi_\alpha \cdot \Delta}(\tau) = e_{\alpha+\tau,\tau} \cdot (\Psi_\alpha)_{\alpha+\tau} = 1 = \deg(V(\alpha) \cdot V(\tau)),$$

where the last equality follows from [Ful93, section 5.1] as $V(\alpha)$ and $V(\tau)$ intersect transversally in the smooth toric variety $X(\Delta)$. If α and τ do not span a cone in Δ , then both sides are clearly zero. Finally, let us assume that the Minkowski sum $\alpha + \tau \in \Delta$ is not maximal. In order to compute the degree of $V(\alpha) \cdot V(\tau)$ we write $V(\alpha)$ as a product of divisors $D_1 \cdots D_k$ and replace the D_i by suitable rationally equivalent divisors $D_i + \text{div}(\chi^{u_i})$

(cf. [Ful93, sections 3.3 and 5.1]). We can thus express the cycle class of $V(\alpha) \cdot V(\tau)$ as a sum of transversal intersections. If r_1, \dots, r_s denote the rays of Δ , then we observe that

$$\sum_j \lambda_j D_{r_j} = \operatorname{div}(\chi^u) \Leftrightarrow \sum_j \lambda_j \Psi_{r_j} = \langle u, \cdot \rangle,$$

where D_{r_j} denotes the divisor corresponding to the ray r_j . This means that adding $\operatorname{div}(\chi^u)$ to a divisor D_r on the toric side corresponds to adding a linear function to the rational function Ψ_r on the tropical side. In particular, both sides of equation (2.1) are not affected by such a change and the claim follows from the two previous cases.

Remark 2.1.14. It was shown in [Bri96, corollary 3.1] that for any unimodular fan F ,

$$\operatorname{PP}^k(F)/\operatorname{LPP}^{k-1}(F) \rightarrow \mathbb{A}^k(X(F)), \quad \overline{\Psi_\sigma} \mapsto \overline{V(\sigma)}$$

is an isomorphism. We note that by the Poincaré duality [Ful98, corollary 17.4], we can regard the rational equivalence class $\overline{V(\sigma)}$ of the orbit closure corresponding to $\sigma \in F^{(k)}$ as an element of the Chow cohomology group $\mathbb{A}^k(X(F))$. If F is also complete, then composing this isomorphism with the Kronecker duality isomorphism

$$\mathbb{A}^k(X(F)) \rightarrow \operatorname{Hom}(\mathbb{A}_k(X(F)), \mathbb{Z}), \quad c \mapsto [a \mapsto \deg(a \cap c)]$$

(cf. [FMSS95, theorem 3]) gives another explanation for the formula of the previous remark.

Proposition 2.1.12 together with the well-known intersections with rational functions enables us to define an intersection product of piecewise polynomials with tropical fan cycles. Later we will use this to construct an intersection product of cocycles with arbitrary cycles.

Definition 2.1.15. Let $h \in \operatorname{PP}^k(X)$ be a piecewise polynomial on a fan cycle $X \in Z_d^{\operatorname{fan}}(V)$. By proposition 2.1.12 we can choose rational fan functions φ_i^j on X such that $h = \sum_{i=1}^s \varphi_1^i \cdots \varphi_k^i \in \operatorname{PP}^k(X)$. This allows us to define the intersection of h with the cycle X to be

$$h \cdot X := \sum_{i=1}^s (\varphi_1^i \cdots \varphi_k^i \cdot X) \in Z_{d-k}^{\operatorname{fan}}(X).$$

In fact, we can define the intersection of h with any (not necessarily fan) subcycle of X in this way.

We have seen in example 2.1.5 that representations of piecewise polynomials as sums of products of rational functions are not unique. Therefore, we need to ensure that our intersection product does not depend on the chosen representation:

Proposition 2.1.16. Let $\varphi_1^i, \dots, \varphi_k^i, \gamma_1^j, \dots, \gamma_k^j$, with $k \leq d$ be rational fan functions on a fan cycle $X \in Z_d^{\operatorname{fan}}(V)$ such that $h := \sum_{i \in I} \varphi_1^i \cdots \varphi_k^i = \sum_{j \in J} \gamma_1^j \cdots \gamma_k^j \in \operatorname{PP}^k(X)$. Then we have the following equation of intersection products of rational functions with cycles:

$$\sum_{i \in I} \varphi_1^i \cdots \varphi_k^i \cdot X = \sum_{j \in J} \gamma_1^j \cdots \gamma_k^j \cdot X.$$

The proof of the proposition makes use of the following technical lemma:

Lemma 2.1.17. Let $c_{b_1 \dots b_s}$ be real numbers such that $\sum_{b_1 + \dots + b_s = k} a_1^{b_1} \cdots a_s^{b_s} \cdot c_{b_1 \dots b_s} = 0$ for all $a_i > 0$, where the sum runs over all non-negative integers b_1, \dots, b_s that sum up to k . Then all $c_{b_1 \dots b_s}$ are 0.

PROOF. For $a_1 \in \{1, \dots, k+1\}$ and any $a_2, \dots, a_s > 0$ we have

$$0 = \sum_{b_1+\dots+b_s=k} a_1^{b_1} \cdots a_s^{b_s} \cdot c_{b_1\dots b_s} = \sum_{b_1=0}^k a_1^{b_1} \sum_{b_2+\dots+b_s=k-b_1} a_2^{b_2} \cdots a_s^{b_s} c_{b_1\dots b_s}.$$

Since the Vandermonde matrix $(i^j)_{i=1,\dots,k+1,j=0,\dots,k}$ is regular, it follows that

$$\sum_{b_2+\dots+b_s=k-b_1} a_2^{b_2} \cdots a_s^{b_s} c_{b_1\dots b_s} = 0$$

for all $a_2, \dots, a_s > 0$ and all $b_1 \in \{0, \dots, k\}$. Hence the claim follows by induction. \square

PROOF OF PROPOSITION 2.1.16. We choose a unimodular fan structure \mathcal{X} of X such that all φ_p^i, γ_p^j are linear on every cone of \mathcal{X} . Let v_1, \dots, v_m be the primitive integral vectors of the rays r_1, \dots, r_m of \mathcal{X} . By lemma 2.1.7, $\varphi_p^i = \sum_{s=1}^m \varphi_p^i(v_s) \cdot \Psi_s$, and we have

$$\begin{aligned} h &= \sum_{i \in I} \varphi_1^i \cdots \varphi_k^i \\ &= \sum_{i \in I} \left(\sum_{s=1}^m \varphi_1^i(v_s) \cdot \Psi_s \right) \cdots \left(\sum_{s=1}^m \varphi_k^i(v_s) \cdot \Psi_s \right) \\ &= \sum_{i \in I} \sum_{1 \leq s_1 \leq \dots \leq s_k \leq m} \sum_{\substack{t_1, \dots, t_k: \\ \{t_1, \dots, t_k\}_m = \{s_1, \dots, s_k\}_m}} \varphi_1^i(v_{t_1}) \cdots \varphi_k^i(v_{t_k}) \cdot \Psi_{s_1} \cdots \Psi_{s_k} \\ &= \underbrace{\sum_{1 \leq s_1 \leq \dots \leq s_k \leq m} \sum_{\substack{t_1, \dots, t_k: \\ \{t_1, \dots, t_k\}_m = \{s_1, \dots, s_k\}_m}} \sum_{i \in I} \varphi_1^i(v_{t_1}) \cdots \varphi_k^i(v_{t_k}) \cdot \Psi_{s_1} \cdots \Psi_{s_k}}_{=: \lambda_{s_1 \dots s_k} \in \mathbb{Z}}, \end{aligned}$$

where $\{t_1, \dots, t_k\}_m = \{s_1, \dots, s_k\}_m$ is an equality of multisets. The linearity and commutativity of intersecting with rational functions [AR10, proposition 3.7] allow us to perform the same computation for the intersection product with X ; thus we have

$$\sum_{i \in I} \varphi_1^i \cdots \varphi_k^i \cdot X = \sum_{1 \leq s_1 \leq \dots \leq s_k \leq m} \lambda_{s_1 \dots s_k} \cdot \Psi_{s_1} \cdots \Psi_{s_k} \cdot X.$$

Analogously we set

$$\mu_{s_1 \dots s_k} := \sum_{\substack{t_1, \dots, t_k: \\ \{t_1, \dots, t_k\}_m = \{s_1, \dots, s_k\}_m}} \sum_{j \in J} \gamma_1^j(v_{t_1}) \cdots \gamma_k^j(v_{t_k})$$

and use the same argument for the γ_p^j to conclude that

$$\sum_{i \in I} \varphi_1^i \cdots \varphi_k^i \cdot X - \sum_{j \in J} \gamma_1^j \cdots \gamma_k^j \cdot X = \sum_{1 \leq s_1 \leq \dots \leq s_k \leq m} \underbrace{(\lambda_{s_1 \dots s_k} - \mu_{s_1 \dots s_k})}_{=: c_{s_1 \dots s_k}} \cdot \Psi_{s_1} \cdots \Psi_{s_k} \cdot X.$$

As $\Psi_{w_1} \cdots \Psi_{w_k} \cdot X = 0$ if the cone $\langle w_1, \dots, w_k \rangle \notin \mathcal{X}$ (this can be showed in the same way as [All12, lemma 1.4]) the above is equal to

$$\sum_{\langle v_{s_1}, \dots, v_{s_k} \rangle \in \mathcal{X}} c_{s_1 \dots s_k} \cdot \Psi_{s_1} \cdots \Psi_{s_k} \cdot X.$$

Note that the s_i are not necessarily pairwise disjoint; that means the sum runs over all cones in \mathcal{X} of dimension at most k . It suffices to prove that all $c_{s_1 \dots s_k}$ occurring in the above sum are equal to 0: Therefore, we fix integers $1 \leq t_1 < \dots < t_k \leq m$ such that

$\langle v_{t_1}, \dots, v_{t_k} \rangle \in \mathcal{X}^{(k)}$ and claim that $c_{s_1 \dots s_k} = 0$ for all $1 \leq s_1 \leq \dots \leq s_k \leq m$ with $\{s_1, \dots, s_k\} \subseteq \{t_1, \dots, t_k\}$: For all $a_1, \dots, a_k > 0$ we have

$$\begin{aligned}
0 &= (h - h)(a_1 v_{t_1} + \dots + a_k v_{t_k}) \\
&= \left(\sum_{1 \leq s_1 \leq \dots \leq s_k \leq m} c_{s_1 \dots s_k} \cdot \Psi_{s_1} \cdots \Psi_{s_k} \right) (a_1 v_{t_1} + \dots + a_k v_{t_k}) \\
&= \sum_{\substack{1 \leq s_1 \leq \dots \leq s_k \leq m \\ \{s_1, \dots, s_k\} \subseteq \{t_1, \dots, t_k\}}} c_{s_1 \dots s_k} \prod_{i=1}^k a_i^{|\{j: s_j = t_i\}|} \\
&= \sum_{b_1 + \dots + b_k = k} c_{\underbrace{t_1 \dots t_1}_{b_1 \text{ times}} \dots \underbrace{t_k \dots t_k}_{b_k \text{ times}}} a_1^{b_1} \cdots a_k^{b_k},
\end{aligned}$$

where the last sum runs over non-negative integers b_i that sum up to k . Now the claim follows from lemma 2.1.17. \square

Example 2.1.18. Let $h \in \text{PP}^2(L_2^3)$ be the piecewise polynomial shown in the following picture. Let \mathcal{X} be the corresponding fan structure of L_2^3 having rays $(-1, 0, 0)$, $(-1, -1, 0)$, $(0, -1, 0)$, $(0, 0, -1)$, $(1, 1, 0)$, $(1, 1, 1)$.

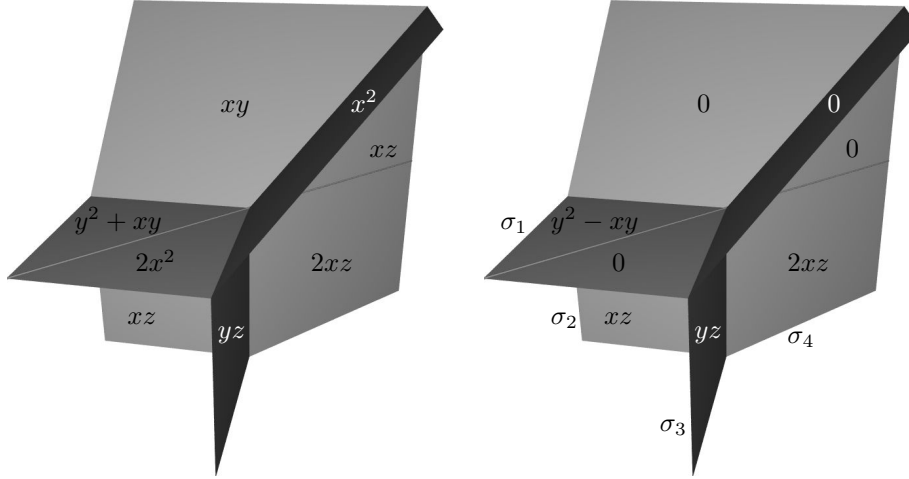

$$h \in \text{PP}^2(\mathcal{X}) \subsetneq \text{PP}^2(L_2^3)$$

$$h + 2x \cdot \Psi_a - x \cdot \Psi_b$$

We want to compute $h \cdot L_2^3$. Therefore, we use the idea of the proof of proposition 2.1.12 to obtain a representation of h as a sum of products of rational functions: We first make h vanish on the rays of \mathcal{X} by adding appropriate (linear) multiples of the rational functions Ψ_r (with r a ray of \mathcal{X}). Doing this we obtain $h + 2x \cdot \Psi_a - x \cdot \Psi_b$, where $a = (-1, -1, 0)$ and $b = (1, 1, 1)$. Now it is easy to see that

$$h + 2x \cdot \Psi_a - x \cdot \Psi_b = -\Psi_{\sigma_1} + \Psi_{\sigma_2} + \Psi_{\sigma_3} - 2 \cdot \Psi_{\sigma_4}.$$

As $\Psi_{\sigma_i} \cdot L_2^3 = 1 \cdot \{0\}$ for all i (cf. lemma 2.1.19) and intersection products with linear functions are zero, we obtain by definition 2.1.15 that

$$h \cdot L_2^3 = (-1 + 1 + 1 - 2) \cdot \{0\} = -1 \cdot \{0\}.$$

Alternatively we can compute our intersection product by extending h to a piecewise polynomial \tilde{h} on \mathbb{R}^3 , multiplying it with a rational function that cuts out L_2^3 and using the formula of definition 2.1.3: Let e_1, e_2, e_3 denote the standard basis vectors in \mathbb{R}^3 and let $e_0 = -e_1 - e_2 - e_3$. The following table shows an extension \tilde{h} of h to \mathbb{R}^3 :

Cone	\tilde{h}	$\max\{x, y, z, 0\} \cdot \tilde{h}$
$\langle -e_0, -e_1, a \rangle$	$xy + y^2 - z^2$	$z(xy + y^2 - z^2)$
$\langle -e_0, -e_2, a \rangle$	$2x^2 - z^2$	$z(2x^2 - z^2)$
$\langle -e_1, -e_3, a \rangle$	$xy + xz + y^2$	0
$\langle -e_2, -e_3, a \rangle$	$2x^2 + yz$	0
$\langle -e_0, -e_2, -a \rangle$	xz	x^2z
$\langle -e_2, -e_3, -a \rangle$	$xz + yz$	$x(xz + yz)$
$\langle -e_0, -e_1, -a \rangle$	xz	xyz
$\langle -e_1, -e_3, -a \rangle$	$xz + yz$	$y(xz + yz)$

By definition $(\tilde{h} \cdot \max\{x, y, z, 0\}) \cdot \mathbb{R}^3$ is the origin with weight

$$\begin{aligned} & \frac{z(xy + y^2 - z^2)}{z(y-x)(z-y)} + \frac{z(2x^2 - z^2)}{z(x-y)(z-x)} + \frac{0}{(y-x)(-z)(-y)} + \frac{0}{(x-y)(-z)(-x)} \\ & + \frac{x^2z}{z(x-y)(x-z)} + \frac{x(xz + yz)}{(x-y)(-z)x} + \frac{xyz}{z(y-x)(y-z)} + \frac{y(xz + yz)}{(y-x)(-z)y}, \end{aligned}$$

which is equal to -1 .

A third possibility is to compute the intersection product of $\max\{x, y, z, 0\}$ with the curve $\tilde{h} \cdot \mathbb{R}^3$. We use definition 2.1.3 to see that $\tilde{h} \cdot \mathbb{R}^3$ is the curve that consists of rays $\langle -e_0 \rangle, \langle -e_3 \rangle$ (both of weight -1), $\langle -e_1 \rangle, \langle -e_2 \rangle$ (of weight -2 each) and $\langle a \rangle$ (of weight 1). For example, the weight of the ray $\langle a \rangle$ in $\tilde{h} \cdot \mathbb{R}^3$ is calculated as

$$c_{\tilde{h} \cdot \mathbb{R}^3}(\langle a \rangle) = \frac{xy + y^2 - z^2}{z(y-x)} + \frac{2x^2 - z^2}{z(x-y)} + \frac{xy + xz + y^2}{(y-x)(-z)} + \frac{2x^2 + yz}{(x-y)(-z)} = 1.$$

Now it is easy to see that intersecting this curve with $\max\{x, y, z, 0\}$ gives the origin with weight -1 .

Lemma 2.1.19. *Let \mathcal{X} be a unimodular fan structure of a fan cycle X of dimension d . Let $\sigma \in \mathcal{X}$ be a maximal cone. Then $\Psi_\sigma \cdot X = \omega_{\mathcal{X}}(\sigma) \cdot \{0\}$.*

PROOF. Let v_1, \dots, v_d be the primitive integral vectors generating the rays of σ . It follows from the definition of Ψ_{v_i} and the intersection product with a rational function that the weight of the cone $\langle v_1, \dots, v_{i-1} \rangle$ in $\Psi_{v_i} \cdots \Psi_{v_d} \cdot \mathcal{X}$ is equal to the weight of $\langle v_1, \dots, v_i \rangle$ in $\Psi_{v_{i+1}} \cdots \Psi_{v_d} \cdot \mathcal{X}$. This implies the claim. \square

We are ready to list the properties the intersection product with piecewise polynomials inherits from the intersection product with rational functions. Therefore, we first notice that piecewise polynomials can be pulled back along morphisms in the same way as rational functions.

Definition 2.1.20. Let $f : X \rightarrow Y$ be a morphism of tropical fan cycles and let $h \in \text{PP}^k(Y)$ be a piecewise polynomial on Y . Then the pull-back of h along f is $f^*h := h \circ f \in \text{PP}^k(X)$. Note that $h \circ f$ is polynomial on the cones of \mathcal{X} if h is polynomial on the cones of \mathcal{Y} and \mathcal{X}, \mathcal{Y} are compatible with respect to f .

Proposition 2.1.21. *Let $h \in \text{PP}^k(X)$ and $h' \in \text{PP}^l(X)$ be piecewise polynomials on a fan cycle X . The intersection product with piecewise polynomials has the following properties:*

- (1) $\text{PP}^k(X) \times Z_l(X) \rightarrow Z_{l-k}(X)$, $(b, C) \mapsto b \cdot C$ is bilinear.
- (2) If $h \in \text{LPP}^{k-1}(X)$, then $h \cdot X = 0$.
- (3) $h \cdot (h' \cdot X) = (h \cdot h') \cdot X = h \cdot (h' \cdot X)$.
- (4) If Y is a fan cycle, then $(h \cdot X) \times Y = \pi^*h \cdot (X \times Y)$, where $\pi : X \times Y \rightarrow X$ maps (x, y) to x .

- (5) $h \cdot (f_* E) = f_*(f^* h \cdot E)$ for a morphism of fan cycles $f : Y \rightarrow X$ and a subcycle E of Y .

PROOF. These properties follow directly from definition 2.1.15 and the respective properties of the intersection product with rational functions (remark 1.2.4, propositions 1.2.9 and 1.2.16, lemma 1.2.15). \square

Remark 2.1.22. A piecewise polynomial $h \in \text{PP}^k(X)$ on a fan cycle X induces a piecewise polynomial $h^p \in \text{PP}^k(\text{Star}_X(p))$ obtained by restricting h to a small neighbourhood of p and then extending it in the obvious way to $\text{Star}_X(p)$. As $h = \sum_{i=1}^s \varphi_1^i \cdots \varphi_k^i$ implies that $h^p = \sum_{i=1}^s (\varphi_1^i)^p \cdots (\varphi_k^i)^p$, it follows from proposition 1.2.9 that

$$h^p \cdot \text{Star}_X(p) = \text{Star}_{h \cdot X}(p).$$

The rest of the section is devoted to comparing the notions of push-forwards and pull-backs of piecewise polynomials introduced in [Bri96, section 2.3] to the tropical push-forward of cycles and the tropical pull-back of piecewise polynomials.

Therefore, let F, F' be two unimodular fans in an n -dimensional vector space such that each cone of F' is contained in a cone of F . Then the identity map on the underlying lattice gives rise to a morphism $\pi : X(F') \rightarrow X(F)$ of the corresponding smooth toric varieties.

Remark 2.1.23. It is obvious that the pull-backs of piecewise polynomials defined in 2.1.20 and [Bri96, theorem 2.3(i)] are equal. By [Bri96, proposition 3.2(i)], this means that our pull-back of piecewise polynomials describes the pull-back morphisms of Chow cohomology groups $\pi^* : A^k(X(F)) \rightarrow A^k(X(F'))$.

Remark 2.1.24. Now, we assume additionally that $\Delta := F$ and $\Delta' := F'$ are complete. Then [Bri96, theorem 2.3(iii)] defines the push-forward of a piecewise polynomial $h \in \text{PP}^k(\Delta')$ along π to be given by

$$(\pi_* h)_\sigma := e_{\sigma, \{0\}}^{-1} \sum_{\sigma' \in \Delta'(n) : \sigma' \subseteq \sigma} e_{\sigma', \{0\}} h_{\sigma'},$$

where σ is a maximal cone in Δ . By [Bri96, proposition 3.2(ii)] this push-forward of piecewise polynomials describes the push-forward $\pi_* : A_{n-k}(X(\Delta')) \rightarrow A_{n-k}(X(\Delta))$ of the Chow homology groups of the corresponding smooth, complete toric varieties. Note that $A_{n-k}(X(\Delta)) \cong \text{PP}^k(\Delta) / \text{LPP}^{k-1}(\Delta)$ by the Poincaré duality and remark 2.1.14, and the same for Δ' .

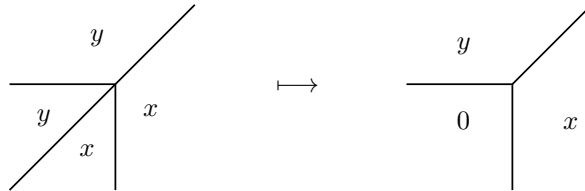

In the picture, π_* maps the rational function $\max\{x, y\} = \Psi_h - \Psi_e$ to the rational function $\max\{x, y, 0\} = \Psi_h$, where $h := (1, 1)$, $e := (-1, -1)$. In the toric setting, this corresponds to $\pi_* : A_1(\text{Bl}(\mathbb{P}^2)) \rightarrow A_1(\mathbb{P}^2)$ mapping $H - E$ to H , where E is the exceptional divisor in the blow-up of the projective plane in a point and H is the class of a line. The above example clearly shows that the push-forward of piecewise polynomials does not agree with the push-forward of tropical cycles as the push-forward of the line $\mathbb{R} \cdot h$ along the identity is $\mathbb{R} \cdot h$ and not L_1^2 .

Proposition 2.1.25. *With the notations and assumptions of remark 2.1.24, we have that for any piecewise polynomials $h \in \text{PP}^k(\Delta')$ and $g \in \text{PP}^{n-k}(\Delta)$*

$$g \cdot (\pi_* h) \cdot \mathbb{R}^n = g \cdot h \cdot \mathbb{R}^n.$$

PROOF. As g and $\pi_* h$ are piecewise polynomials on Δ definition 2.1.3 says that

$$\begin{aligned} (g \cdot \pi_* h) \cdot \Delta &= \sum_{\sigma \in \Delta^{(n)}} e_{\sigma, \{0\}} \cdot (\pi_* h)_\sigma \cdot g_\sigma \\ &= \sum_{\sigma \in \Delta^{(n)}} \sum_{\sigma' \in \Delta'^{(n)}: \sigma' \subseteq \sigma} e_{\sigma', \{0\}} \cdot h_{\sigma'} \cdot g_\sigma \\ &= \sum_{\sigma' \in \Delta'^{(n)}} e_{\sigma', \{0\}} \cdot h_{\sigma'} \cdot g_{\sigma'} \\ &= g \cdot h \cdot \Delta', \end{aligned}$$

which proves the claim. \square

Corollary 2.1.26. *With the notations and assumptions of remark 2.1.24 and $\Delta = \mathcal{L}_n^n$, we have that for any piecewise polynomial $h \in \text{PP}^k(\Delta')$*

$$(\pi_* h) \cdot \mathbb{R}^n = (\deg(h \cdot \mathbb{R}^n)) \cdot L_{n-k}^n,$$

where $\deg(\cdot)$ denotes the degree of a cycle introduced in definition 1.3.9.

PROOF. Since $\pi_* h \in \text{PP}^k(\mathcal{L}_n^n)$ and L_{n-k}^n is irreducible we can conclude that $(\pi_* h) \cdot \mathbb{R}^n$ is a multiple of L_{n-k}^n . Therefore, it suffices to prove that $h \cdot \mathbb{R}^n$ and $(\pi_* h) \cdot \mathbb{R}^n$ have the same degree which follows from proposition 2.1.25 using the piecewise polynomial $g = \max\{x_1, \dots, x_n, 0\}^{n-k}$. \square

2.2. Abstract tropical cycles

The aim of this section is to introduce abstract tropical cycles, that means cycles that are not necessarily embedded in a vector space. An abstract tropical cycle is a topological space with a weight function and local embeddings into tropical fan cycles. These local embeddings allow us to extend intersection-theoretic operations to abstract cycles; in particular we will intersect tropical cocycles (on abstract cycles) with abstract subcycles in the next section.

This section is based on an idea by Johannes Rau and is consistent with the definition of smooth varieties introduced in [FR]. Compared to the abstract cycles of [AR10], the abstract cycles presented in this section avoid many of the technical difficulties which have arisen when intersection-theoretic operations have been performed. Other than that, there is not much difference between these two definitions.

Definition 2.2.1. A weighted topological space (X, ω_X, U) is a topological space X together with an integer weight function $\omega_X : U \rightarrow \mathbb{Z} \setminus \{0\}$ on the dense open subset U which is locally constant in U . Two weighted topological spaces are said to agree and will be identified if the underlying topological spaces are equal and their weight functions agree where both are defined.

Remark 2.2.2. Let \mathcal{X} be a polyhedral structure (all of whose maximal cells have non-zero weight) of a tropical cycle X in a vector space V . We can regard X as a topological space by equipping it with the subspace topology of the euclidean topology in V and make it weighted by giving each point contained in the relative interior of a maximal cell the weight of the maximal cell. Note that the complement of the union of the codimension 1 cells is open and dense in X . It follows straight from the definition that the corresponding weighted topological space does not depend on the chosen polyhedral structure.

Definition 2.2.3. A weighted subspace C of a weighted space X is a subspace topology of X which is itself weighted. For a weighted subspace C of X and an open set U in X we equip the subspace topology $C \cap U$ with the weights inherited from C ; that means we set $\omega_{C \cap U}(p) := \omega_C(p)$ for all points p in the intersection of U and the domain of the weight function ω_C . If $\phi : U \rightarrow W$ is a homeomorphism, then $\phi(C \cap U)$ becomes a weighted space by inheriting the weights of $C \cap U$.

We say that a weighted subspace C of a vector space V (which contains a lattice and is equipped with the euclidean topology) is an open cycle of dimension d if there are a cycle $D \in Z_d(V)$ and an open subset $U \subseteq V$ such that $C = D \cap U$. If D can be chosen to be a fan cycle and U contains the origin, then we call C an open fan cycle.

Definition 2.2.4. An (abstract) tropical cycle of dimension d is a weighted topological space X together with a finite open cover $\{U_i\}$ and homeomorphisms

$$\phi_i : U_i \rightarrow W_i$$

such that:

- Each W_i is a euclidean open subset of a real vector space V^{W_i} (associated to a lattice) and contains the origin.
- For all i the set $\mathbb{R}_{\geq 0} \cdot W_i := \{\lambda \cdot x : x \in W_i, \lambda \in \mathbb{R}_{\geq 0}\}$ is the support of a d -dimensional tropical fan cycle X_i in V^{W_i} such that the weight of each point $p \in U_i$ is equal to the weight of $\phi_i(p)$ in X_i (if both are defined).
- For each pair i, k , the transition map

$$\phi_k \circ \phi_i^{-1} : \phi_i(U_i \cap U_k) \rightarrow \phi_k(U_i \cap U_k)$$

is the restriction of an integer affine linear map.

As usually, we denote the underlying set of X by $|X|$.

Remark 2.2.5. The local blocks X_i of an abstract cycle X are uniquely defined by the properties one and two of definition 2.2.4; this is why we insist that the sets W_i contain the origin. Note that the first two conditions of the previous definition are equivalent to requiring that each W_i (together with the weight function inherited from U_i) is an open fan cycle in V^{W_i} .

Definition 2.2.6. An r -dimensional subcycle C of an abstract cycle X is a weighted subspace of X such that for all i the weighted space $\phi_i(C \cap U_i)$ agrees with the intersection of W_i and (the weighted topological space associated to) a tropical cycle $C_i \in Z_r(V^{W_i})$. The sum of two subcycles C, D (of the same dimension) is obtained by adding the local cycles C_i and D_i in V^{W_i} (cf. construction 1.1.20). Note that this does not depend on the choice of local cycles C_i and D_i . The group of r -dimensional subcycles of the abstract cycle X is denoted by $Z_r(X)$.

Definition 2.2.7. The cross product $X \times X'$ of two tropical cycles X, X' is the product topology with weight function $\omega_{X \times X'}(p, p') := \omega_X(p) \cdot \omega_{X'}(p')$ (if both weights are defined) together with the open cover $\{U_i \times U'_j\}$ and homeomorphisms $\phi_i \times \phi'_j$. Note that the local blocks of the cross product are just cross products of the local blocks.

Definition 2.2.8. A morphism $f : X \rightarrow Y$ of abstract tropical cycles X, Y is a continuous map such that for all i, j the map

$$\phi_j^Y \circ f \circ (\phi_i^X)^{-1} : W_i^X \cap \phi_i^X(f^{-1}(U_j^Y)) \rightarrow \phi_j^Y(f(U_i^X)) \cap W_j^Y$$

on the charts is induced by an integer affine linear map of the ambient vector spaces. A morphism f which respects the weights (i.e. $\omega_X(p) = \omega_Y(f(p))$ if both are defined) is an isomorphism if there is an inverse tropical morphism $g : Y \rightarrow X$.

Remark 2.2.9. Abstract tropical cycles are more general than tropical cycles in vector spaces: If \mathcal{X} is a polyhedral structure of a cycle X in V , then we can regard X as an abstract cycle with open cover $\{U(\tau) : \tau \in \mathcal{X} \text{ minimal}\}$, where $U(\tau) := \cup_{\sigma > \tau} \text{Int}(\sigma)$, and translation homeomorphisms

$$\phi_\tau : U(\tau) \rightarrow U(\tau) - p_\tau \subseteq |\text{Star}_X(p_\tau)|, \quad x \mapsto x - p_\tau,$$

where p_τ is a point in the relative interior of τ . It is clear that the definitions of morphisms 1.1.27 and 2.2.8 agree for cycles in vector spaces. Using the above reasoning we also notice that subcycles of abstract cycles are themselves abstract cycles and that restrictions of morphisms to subcycles are again morphisms.

Definition and Construction 2.2.10. Let $f : X \rightarrow Y$ be a morphism of abstract cycles. We want to construct the push-forward $f_*X \in Z_{\dim X}(Y)$. For a point q in $f(|X|)$ we choose j such that $q \in U_j^Y$. For every point $p \in f^{-1}\{q\}$ we choose i_p such that $p \in U_{i_p}^X$. Let $f_{i_p, j}^p : \text{Star}_{X_{i_p}}(\phi_{i_p}^X(p)) \rightarrow \text{Star}_{Y_j}(\phi_j^Y(q))$ be the morphism induced by the map $\phi_j^Y \circ f \circ (\phi_{i_p}^X)^{-1}$. Then the push-forward f_*X is locally (on Y_j around q) given by the sum

$$\sum_{p \in f^{-1}\{q\}} (f_{i_p, j}^p)_* \text{Star}_{X_{i_p}}(\phi_{i_p}^X(p)).$$

Note that all but finitely many of these summands are zero. As $\phi_{i_p} \circ (\phi_{i'_p})^{-1}$ induces an isomorphism between $\text{Star}_{X_{i'_p}}(\phi_{i'_p}^X(p))$ and $\text{Star}_{X_{i_p}}(\phi_{i_p}^X(p))$ the definition does not depend on the choice of i_p . An analogous argument allows us to conclude that the local push-forwards agree on the overlaps and can thus be glued together to a cycle $f_*X \in Z_{\dim X}(Y)$. As usually, the push-forward f_*C of a subcycle C of X is defined to be the push-forward $(f|_C)_*C$ of C along the restriction of f to C .

Remark 2.2.11. If f is a morphism of cycles in vector spaces, then definition 2.2.10 gives the same result as definition 1.1.29. This follows immediately from the locality of pushing forward stated in proposition 1.1.31.

2.3. Intersecting with tropical cocycles

In this section we use piecewise polynomials to define higher codimension cocycles on abstract tropical cycles X as well as their intersection product. These cocycles generalise the known Cartier divisors and satisfy the expected properties. We also show a Poincaré duality on vector spaces.

We start by defining piecewise polynomials on open subsets of a tropical fan cycle.

Definition 2.3.1. Let X be a fan cycle in a vector space V and let U be a euclidean open subset in $|X|$. A continuous function $h : U \rightarrow \mathbb{R}$ is called piecewise polynomial of degree k on U if it is locally around each point $p \in U$ a finite sum $\sum_j (h_p^j \circ T_p^j)$ of compositions of (restrictions of) piecewise polynomials $h_p^j \in \text{PP}^k(\text{Star}_X(p))$ and translations T_p^j . We define $h_p \in \text{PP}^k(\text{Star}_X(p))$ to be the (uniquely defined) sum of the h_p^j . The group of piecewise polynomials of degree k on U is denoted by $\text{PP}^k(U)$. Furthermore, $\text{LPP}^{k-1}(U)$ is the group of piecewise polynomials h (of degree k) on U such that $h_p \in \text{LPP}^{k-1}(\text{Star}_X(p))$ for all points $p \in U$.

We now generalise the notion of Cartier divisors (i.e. codimension 1 cocycles) introduced in [AR10, definition 6.1] by using piecewise polynomials (instead of piecewise linear functions) as local descriptions:

Definition 2.3.2. A representative of a codimension k cocycle on the cycle X is defined to be a set $\{(V_1, h_1), \dots, (V_p, h_p)\}$ satisfying

- $\{V_i\}$ is an open cover of $|X|$;
- $(h_j \circ \phi_i^{-1})|_{\phi_i(U_i \cap V_j)} \in \text{PP}^k(\phi_i(U_i \cap V_j))$ for all i, j ;
- $((h_j - h_k) \circ \phi_i^{-1})|_{\phi_i(U_i \cap V_j \cap V_k)} \in \text{LPP}^{k-1}(\phi_i(U_i \cap V_j \cap V_k))$ for all i, j, k .

The sum of two (representatives of) codimension k cocycles $\{(V_j, h_j)\}$ and $\{(V'_k, h'_k)\}$ is defined to be $\{(V_j \cap V'_k, h_j + h'_k)\}$. We call two representatives of codimension k cocycles $\{(V_j, h_j)\}$ and $\{(V'_k, h'_k)\}$ equivalent (and identify them) if we have for all i, s that

$$(g_s \circ \phi_i^{-1})|_{\phi_i(U_i \cap K_s)} \in \text{LPP}^{k-1}(\phi_i(U_i \cap K_s)),$$

where $\{(K_s, g_s)\} := \{(V_j, h_j)\} - \{(V'_k, h'_k)\}$.

The group of codimension k cocycles on X is denoted by $C^k(X)$. The multiplication of two cocycles can be defined in the same way as the addition; therefore, there is a graded ring $C^*(X) := \bigoplus_{k \in \mathbb{N}} C^k(X)$ called the ring of cocycles.

Example 2.3.3. For any cycle X , $C^1(X)$ is the group of Cartier divisors $\text{Div}(X)$ introduced in [AR10, definition 6.1].

Example 2.3.4. Vector bundles $\pi : F \rightarrow X$ of degree r on tropical cycles X have been introduced in [All, definition 1.5]. A rational section $s : X \rightarrow F$ with open cover U_1, \dots, U_s induces rational functions $s_{ij} := p_j^{(i)} \circ \Phi_i \circ s : U_i \rightarrow \mathbb{R}$ (cf. [All, definition 1.18]). Here the Φ_i are homeomorphisms identifying $\pi^{-1}(U_i)$ with $U_i \times \mathbb{R}^r$ and the $p_j^{(i)} : U_i \times \mathbb{R}^r \rightarrow \mathbb{R}$ are projections to the j -th component of \mathbb{R}^r . For any $k \leq r$ one obtains the cocycle $s^{(k)} := \{(U_i, \sum_{1 \leq j_1 \leq \dots \leq j_k \leq r} s_{ij_1} \cdots s_{ij_k})\} \in C^k(X)$ (see [All, definition 2.1]).

We are now ready to construct an intersection product of cocycles with tropical cycles. As cocycles are locally given by piecewise polynomials, the idea is to glue together the local intersection products of definition 2.1.15.

Definition and Construction 2.3.5. Let $h = \{(V_j, h_j)\} \in C^k(X)$ be a codimension k cocycle on a tropical cycle X . For a point p in X we choose i, j such that $p \in U_i \cap V_j$. By definition, $(h_j \circ \phi_i^{-1})_p \in \text{PP}^k(\text{Star}_{X_i}(\phi_i(p)))$ is a piecewise polynomial on the star around $\phi_i(p)$. Thus we can define the local intersection $(h_j \circ \phi_i^{-1}) \cdot (X_i \cap \phi_i(U_i \cap V_j))$ by

$$\text{Star}_{(h_j \circ \phi_i^{-1}) \cdot (X_i \cap \phi_i(U_i \cap V_j))}(\phi_i(p)) := (h_j \circ \phi_i^{-1})_p \cdot \text{Star}_{X_i}(\phi_i(p)).$$

As $\phi_k \circ \phi_i^{-1}$ induces an isomorphism of the stars $\text{Star}_{X_i}(\phi_i(p))$ and $\text{Star}_{X_k}(\phi_k(p))$, the definition does not depend on the choice of open set U_i .

We can glue together the local intersections to a subcycle $h \cdot X \in Z_{\dim X - k}(X)$ of X : If $p \in U_i \cap V_j \cap V_s$, then $((h_j - h_s) \circ \phi_i^{-1})_p \in \text{LPP}^{k-1}(\text{Star}_{X_i}(\phi_i(p)))$. Therefore, it follows by part (2) of proposition 2.1.21 that the local intersections agree on the overlaps.

Remark 2.3.6. In the same way we can also intersect cocycles on X with any subcycle of X . Hence, definition 2.3.5 gives rise to an intersection product

$$C^k(X) \times Z_l(X) \rightarrow Z_{l-k}(X), \quad (h, C) \mapsto h \cdot C.$$

Example 2.3.7. We consider the cocycle $h = \{(V_1, h_1), (V_2, h_2)\} \in C^2(\mathbb{R}^2)$ showed in the following picture, where $R = (-1, -1)$ and $Q = (2, 2)$.

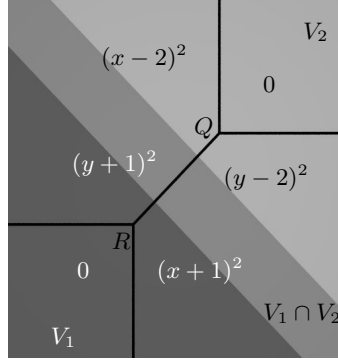

Note that for $p = (t, t)$ with $-1 < t < 2$ we have

$$(h_1 - h_2)_p = (h_1)_p - (h_2)_p = (\max\{x, y\})^2 - (\min\{x, y\})^2 = (y+x) \cdot \max\{x-y, y-x\},$$

which is in $\text{LPP}^1(\text{Star}_p(\mathbb{R}^2))$ (cf. definition 2.3.1); hence h is indeed a cocycle. As $(h_1)_R$ is the piecewise polynomial of example 2.1.5 we conclude that the multiplicity of R in $h \cdot \mathbb{R}^2$ is 1. We can deduce from an analogous argument for the point Q that $h \cdot \mathbb{R}^2 = R + Q$.

As in the case of Cartier divisors [AR10, proposition 7.6], we can pull back cocycles along morphisms.

Definition 2.3.8. The pull-back $f^*h \in C^k(Y)$ of a codimension k cocycle $h = \{(V_j, h_j)\}$ in $C^k(X)$ along a morphism $f : Y \rightarrow X$ of abstract cycles is defined to be the cocycle $\{(f^{-1}(V_j), h_j \circ f)\}$.

Proposition 2.3.9. *The following properties hold for cocycles $h \in C^k(X)$ and $h' \in C^l(X)$ on a cycle X :*

- (1) $C^k(X) \times Z_l(X) \rightarrow Z_{l-k}(X)$, $(b, C) \mapsto b \cdot C$ is bilinear.
- (2) $h \cdot (h' \cdot X) = (h \cdot h') \cdot X = h' \cdot (h \cdot X)$.
- (3) $h \cdot (f_*E) = f_*(f^*h \cdot E)$ for a morphism $f : Y \rightarrow X$ and a subcycle E of Y .
- (4) If Y is a cycle, then $(h \cdot X) \times Y = \pi^*h \cdot (X \times Y)$, where $\pi : X \times Y \rightarrow X$ maps (x, y) to x .
- (5) If D is rationally equivalent to 0 on X , then so is $h \cdot D$.

PROOF. We first notice that all statements except (5) can be verified locally (which means for piecewise polynomials on fan cycles) and thus follow from proposition 2.1.21. Using (3) the proof of (5) is the same as the proof of [AR, lemma 2(b)]. \square

For the rest of the chapter we focus on cocycles on vector spaces. We use theorem 2.1.3 to establish a Poincaré duality for this case:

Theorem 2.3.10. *For any vector space V and any $k \leq n := \dim V$, the following is a group isomorphism:*

$$C^k(V) \rightarrow Z_{n-k}(V), \quad h \mapsto h \cdot V.$$

PROOF. We first consider the corresponding local statement: Since every fan cycle in V has a fan structure lying in a complete, unimodular fan (lemma 1.1.19 and [Ful93, section 2.6] or [Rau09, proposition 1.1.2]), we can use theorem 2.1.3 to conclude that

$$\text{PP}^k(V) / \text{LPP}^{k-1}(V) \rightarrow Z_{n-k}^{\text{fan}}(V), \quad h \mapsto h \cdot V$$

is an isomorphism.

For the global case we start by proving the surjectivity. So let $C \in Z_{n-k}(V)$ be an arbitrary subcycle of V . We choose an open cover $\{V_j\}$ of V and translation functions T_j such that $T_j(C \cap V_j)$ is an open fan cycle (cf. definition 2.2.3) for all j . By the local statement

we can choose for each j a piecewise polynomial h_j whose intersection with V is the fan cycle associated to $T_j(C \cap V_j)$. Then $h = \{(V_j, h_j \circ T_j)\} \in C^k(V)$ is a cocycle satisfying $h \cdot V = C$. By construction the difference of two of these local functions gives a zero intersection on the overlaps of two open sets, i.e. the local intersection $(h_j \circ T_j - h_k \circ T_k) \cdot (V \cap V_1 \cap V_2) = 0$; therefore, the injectivity part of the local statement implies that the third condition of definition 2.3.2 is fulfilled and h is indeed a cocycle on V .

The injectivity follows immediately from the local statement. \square

Remark 2.3.11. Let \mathcal{X} be a unimodular tropical fan and let \mathcal{Y} be a Minkowski weight of codimension k in \mathcal{X} . We know by proposition 2.1.12 that the set $\{\Psi_\tau : \tau \in \mathcal{X}^{(k)}\}$ generates $\text{PP}^k(\mathcal{X})/\text{LPP}^{k-1}(\mathcal{X})$. Finding a piecewise polynomial on \mathcal{X} that cuts out \mathcal{Y} therefore boils down to finding an integer solution of the system

$$\sum_{\tau \in \mathcal{X}^{(k)}} a_\tau (\Psi_\tau \cdot \mathcal{X}) = \mathcal{Y}$$

of $\#\mathcal{X}^{(\dim Y)}$ linear equations and variables $a_\tau, \tau \in \mathcal{X}^{(k)}$. Note that, unless \mathcal{X} is complete, this system is in no way guaranteed to have a solution. In the case that \mathcal{X} is complete and $k = 1$, one can also find a rational function φ that cuts out \mathcal{Y} by inductively determining the linear functions φ_σ along a path of adjacent maximal cones of \mathcal{X} [FS97, proof of corollary 2.4].

In order to find a concrete piecewise polynomial on a vector space V that cuts out a fan cycle Y in V , one can thus use the strategy of lemma 1.1.19 to find fan structures such that \mathcal{Y} is a Minkowski weight in Δ , subdivide both to make \mathcal{Y} a unimodular Minkowski in the unimodular fan Δ [Rau09, proposition 1.1.2] and then solve the above system of linear equations. Note that this method leads to a potentially very large number of equations and variables.

Intersection theory on matroid varieties

Matroid varieties are a natural generalisation of tropicalisations of classical linear spaces. They come with a natural fan structure given in terms of the flats of the underlying matroid, and many matroid-theoretic operations translate nicely to the tropical world. All this makes them natural candidates for the local building blocks of smooth tropical varieties.

In this chapter we construct an intersection product of cycles on matroid varieties (and thus on smooth varieties) and show that it has the expected properties. Our intersection product generalises and agrees with the intersection product of [All12] defined on cycles that locally look like cross products of L_k^n . We also construct a pull-back of cycles along morphisms of smooth varieties and show that every cycle on a matroid variety is rationally equivalent to its recession cycle and can be cut out by a cocycle.

Our strategy is to find rational functions on the product $B(M) \times B(M)$ that cut out the diagonal of matroid variety $B(M)$. These functions can then be used in the same way as in [AR10, All12] to define an intersection product of cycles. It turns out that any matroid variety contained in a bigger matroid variety can be cut out by rational functions given in terms of the rank functions of the respective matroids. Since the class of matroid varieties is closed under taking cross products and diagonals, this gives us the required functions.

In comparison to [All12], we cut out the diagonal by a product of explicitly given, symmetric functions, rather than by a sum of products of rational functions output by an algorithm. This is often beneficial in theoretical considerations and simplifies some proofs but comes at the expense of finer fan structures. Furthermore, matroid varieties come with a natural lineality space $\mathbb{R} \cdot (1, \dots, 1)$. Although one is often more interested in the matroid variety modulo lineality space, we first introduce our intersection theory on matroid varieties. We deal with the rather technical task of constructing an intersection product on a matroid variety modulo lineality space from the intersection product on the matroid variety in the fourth section.

An alternative approach to construct an intersection product on matroid varieties was presented by Shaw in [Sha]. She uses projections and modifications to give a recursive definition that finally uses the known intersection product on \mathbb{R}^n . We use the link between pull-backs of cycles and tropical modifications to show that both intersection products actually agree.

Sections 1 to 7 mainly consist of joint work with Johannes Rau published in [FR]. As every section contains ideas of both of us it is virtually impossible to single out the exact contribution each of us made. However, it is fair to say that the overall idea for the project of constructing an intersection product on matroid varieties by cutting out the diagonal as well as the idea to present section 2 using matroid quotients rather than more ad hoc intersection-theoretic computations are due to Johannes Rau, whereas section 7 is to a large extent due to myself. Some new results are contained in sections 3 and 6. Section 8 mainly covers material published in [Fra].

3.1. Matroid varieties

The aim of this section is to define matroid varieties and prove their main properties, most of which have already been proven in one way or another in [FS05, AK06, MS, Spe08]. We start by briefly recalling some equivalent definitions of matroids and refer to [Oxl92] for further details about matroids.

Notation 3.1.1. Let E be a set and $A \subseteq E, x \in E$. In the context of matroid theory one often writes $A \cup x$ for $A \cup \{x\}$ and $A \setminus x$ for $A \setminus \{x\}$.

Definition 3.1.2. A matroid $M = (E, \mathcal{B})$ is a finite set E together with a non-empty set \mathcal{B} of subsets of E satisfying the basis exchange property: If $B_1, B_2 \in \mathcal{B}$ and $x \in B_1 \setminus B_2$, then there is an element $y \in B_2 \setminus B_1$ such that $(B_1 \setminus x) \cup y \in \mathcal{B}$. Elements of \mathcal{B} are called bases of M , the set E (which is also sometimes denoted by $E(M)$) is called the ground set of M . It can be shown that each basis of M has the same number of elements called the rank $r(M)$ of M .

We can assign each subset A of E a rank by setting

$$r(A) := \max\{|A \cap B| : B \text{ basis of } M\}. \quad (3.1)$$

This gives us a rank function $r : \mathcal{P}(E) \rightarrow \mathbb{Z}_{\geq 0}$ having the following properties:

- (1) $r(\emptyset) = 0$.
- (2) If $A \subseteq E$ and $x \in E$, then $r(A) \leq r(A \cup x) \leq r(A) + 1$.
- (3) If $A \subseteq E$ and $x, y \in E$ such that $r(A \cup x) = r(A \cup y) = r(A)$, then $r(A \cup x \cup y) = r(A)$.

The third property of the rank function is a consequence of the basis exchange property: Assume that $x, y \notin A$ and $r(A) = r(A \cup x) = r(A \cup y) = r(A \cup x \cup y) - 1$. Then we can choose bases B, B' such that $|B \cap A| = r(A) - 1$, $\{x, y\} \subseteq B$ and $|B' \cap A| = r(A)$, $B' \cap \{x, y\} = \emptyset$. If $z' \in B' \setminus (B \cup A)$, then our assumptions clearly imply that only elements of $B \setminus (B' \cup A \cup \{x, y\})$ can (potentially) be added to $B' \setminus z'$ to form a basis of M . But $|B| = |B'|$ implies that $|B' \setminus (B \cup A)| = |B \setminus (B' \cup A \cup \{x, y\})| + 1$, which means that repeatedly using the basis exchange property in this way eventually leads to a contradiction.

On the other hand one can show that a function $r : \mathcal{P}(E) \rightarrow \mathbb{Z}_{\geq 0}$ fulfilling the above conditions is the rank function of the matroid whose bases are all subsets $A \subseteq E$ that satisfy $|A| = r(A) = r(E)$.

The closure $\text{cl}(A)$ of a subset $A \subseteq E$ in the matroid M is

$$\text{cl}(A) := \{x \in E : r(A \cup x) = r(A)\}.$$

In other words, the closure of A is the maximal subset of E that contains A and has the same rank as A . If $A_1 \subseteq A_2$, then equation (3.1) implies that for all $x \in E$

$$r(A_2 \cup x) - r(A_2) = 1 \Rightarrow r(A_1 \cup x) - r(A_1) = 1;$$

thus $\text{cl}(A_1) \subseteq \text{cl}(A_2)$. Closed sets (i.e. sets A with $A = \text{cl}(A)$) are called flats of M . Knowing the above, it is easy to see that the flats of a matroid have the following properties:

- (1) E is a flat of M .
- (2) The intersection of two flats is again a flat.
- (3) If $\{F_1, \dots, F_p\}$ are the minimal flats strictly containing a flat F , then $E \setminus F$ is the disjoint union of the $F_i \setminus F$.

The set of flats uniquely defines a rank function and thus a matroid, namely

$$r(A) := \max\{i : \text{cl}(\emptyset) =: F_0 \subsetneq F_1 \subsetneq F_2 \subsetneq \dots \subsetneq F_i = \text{cl}(A) \text{ is a chain of flats in } M\},$$

where $\text{cl}(A)$ is just the minimal flat of M containing A .

Remark 3.1.3. One can also describe the matroid M by its independent sets (i.e. subsets of bases), its circuits (i.e. minimal dependent sets) or its hyperplanes (i.e. flats of rank $r(M) - 1$). This means that inclusion-maximal independent sets are bases and that a set is independent if and only if it does not contain any circuit.

Definition 3.1.4. A loop of a matroid M is an element $a \in E(M)$ such that the set $\{a\}$ has rank 0; in other words, a is not contained in any basis of M . An element $a \in E(M)$ is a coloop in M if it is contained in every basis of M .

Convention 3.1.5. In the following, unless explicitly told otherwise, all matroids are assumed to be loopfree, i.e. not to contain any loops.

Example 3.1.6. Let v_1, \dots, v_n be (non-zero) vectors in a vector space V over a field K . Then the function r mapping a set $A \subseteq \{1, \dots, n\}$ to the dimension of the linear span of the set $\{v_i : i \in A\}$ is the rank function of a matroid. The independent sets of the matroid correspond exactly to the linearly independent sets in $\{v_1, \dots, v_n\}$. Matroids of this form are called realisable (or representable) over the field K .

Definition 3.1.7. The direct sum $M \oplus N$ of two matroids M and N is the matroid whose ground set is the disjoint union $E(M) \dot{\cup} E(N)$ and whose set of bases is the set $\{B_M \dot{\cup} B_N : B_M, B_N \text{ bases of } M, N \text{ respectively}\}$. Note that a subset of $E(M) \dot{\cup} E(N)$ is a flat of $M \oplus N$ if and only if it is a disjoint union $F_M \dot{\cup} F_N$ of a flat F_M of M and a flat F_N of N .

Example 3.1.8. The Fano matroid F_7 on the set $\{1, \dots, 7\}$ is the matroid of rank 3 whose rank one flats are the singletons and whose rank two flats are

$$\{1, 2, 3\}, \{1, 4, 7\}, \{1, 5, 6\}, \{2, 5, 7\}, \{3, 4, 5\}, \{3, 6, 7\}, \{2, 4, 6\}.$$

The anti-Fano (or non-Fano) matroid F_7^- on $\{1, \dots, 7\}$ is the matroid of rank 3 whose rank one flats are the singletons and whose rank two flats are

$$\{1, 2, 3\}, \{1, 4, 7\}, \{1, 5, 6\}, \{2, 5, 7\}, \{3, 4, 5\}, \{3, 6, 7\}, \{2, 4\}, \{2, 6\}, \{4, 6\}.$$

The Fano matroid is realisable over the field K if and only if K has characteristic 2; the anti-Fano matroid is realisable over K if and only if its characteristic is not 2 (cf. [Ox192, proposition 6.4.8]). Therefore, their direct sum $F_7 \oplus F_7^-$ is not realisable over any field. This is not the smallest matroid that is not realisable over any field in the sense that there are matroids of rank 4 on $\{1, \dots, 8\}$ which have this property (cf. [Ox192, propositions 6.1.10, 6.1.11, 6.4.10]).

We are ready to state the definition of a matroid fan and show that it fulfils the balancing condition.

Definition 3.1.9. Let M be a matroid on the ground set $E := \{1, \dots, n\}$. Let $\{e_1, \dots, e_n\}$ be the standard basis of \mathbb{R}^n . Then $\mathcal{B}(M)$ is the fan of pure dimension $r(M)$ which consists of cones

$$\langle \mathcal{F} \rangle := \left\{ \sum_{i=1}^p \lambda_i \cdot V_{F_i} : \lambda_1, \dots, \lambda_{p-1} \geq 0, \lambda_p \in \mathbb{R} \right\},$$

where $\mathcal{F} = (\emptyset \subsetneq F_1 \subsetneq \dots \subsetneq F_{p-1} \subsetneq F_p = E)$ is a chain of flats in M , and $V_F = -\sum_{i \in F} e_i$ denotes the vector corresponding to the flat F . We make $\mathcal{B}(M)$ weighted by assigning each maximal cone the trivial weight 1. Note that, by definition, $\mathcal{B}(M)$ has lineality space $\mathbb{R} \cdot (1, \dots, 1)$.

Proposition 3.1.10. *Every matroid fan $\mathcal{B}(M)$ is balanced.*

PROOF. Let $r := r(M)$ and let $\tau = \langle \emptyset \subsetneq F_1 \subsetneq F_2 \subsetneq \dots \subsetneq F_{r-1} = E \rangle$ be an arbitrary cone of codimension 1 in $\mathcal{B}(M)$. Then there exists s such that $r(F_i) = i$ for $i \leq s$ and $r(F_i) = i + 1$ for $i \geq s + 1$. The facets around τ are of the form

$$\langle \emptyset \subsetneq F_1 \subsetneq \dots \subsetneq F_s \subsetneq F \subsetneq F_{s+1} \subsetneq \dots \subsetneq F_{r-1} = E \rangle,$$

where F is a flat of M . Thus it suffices to prove the equality

$$\sum_{\substack{F_s \subsetneq F \subsetneq F_{s+1} \\ F \text{ flat}}} V_F = V_{F_{s+1}} + (|\{F : F \text{ flat with } F_s \subsetneq F \subsetneq F_{s+1}\}| - 1) \cdot V_{F_s} \in V_\tau,$$

whose right-hand side is clearly contained in V_τ . The equality of vectors is clear for coordinates $j \notin F_{s+1}$ (as the entries on both sides are 0) and for coordinates $j \in F_s$ (as the entry is $-|\{F : F \text{ flat with } F_s \subsetneq F \subsetneq F_{s+1}\}|$ on both sides). For $j \in F_{s+1} \setminus F_s$ the claim follows from the fact that j is contained in exactly one of the flats between F_s and F_{s+1} , namely in $\text{cl}(F_s \cup j)$. Note that it cannot be contained in more than one by the third property on flats of a matroid. \square

Definition 3.1.11. A tropical cycle is called matroid variety if it is the cycle associated to a matroid fan $\mathcal{B}(M)$. The matroid variety associated to $\mathcal{B}(M)$ is denoted by $B(M)$.

Our next aim is to show how the support of a matroid variety can be described in terms of the bases of the underlying matroid.

Definition 3.1.12. Let M be a matroid on the ground set $E = \{1, \dots, n\}$. For $p \in \mathbb{R}^n$ we define the p -weight of a basis B to be the sum $\sum_{i \in B} p_i$. Then \mathcal{B}_p is defined to be the set of bases of M that have minimal p -weight.

Lemma 3.1.13. *With the notation of the previous definition, we have that $M_p := (E, \mathcal{B}_p)$ is indeed a matroid.*

PROOF. Let $a_1 < a_2 < \dots < a_s$ such that the sets $\{a_1, \dots, a_s\}$ and $\{p_1, \dots, p_n\}$ are equal. We set $A_i := \{j : p_j \leq a_i\}$ and claim that

$$\mathcal{B}_p = \{B : B \text{ basis of } M, |B \cap A_i| = r(A_i) \text{ for all } i\}. \quad (3.2)$$

We first prove the existence of a basis B_1 of M with $|B_1 \cap A_i| = r(A_i)$ for all i : We choose $x_1 \in A_1$. For $2 \leq i \leq r(M)$, we set

$$j_i := \min\{q : r(A_q) > i - 1\}$$

and choose an element $x_i \in A_{j_i} \setminus \text{cl}(\{x_1, \dots, x_{i-1}\})$. An easy induction shows that $r(\{x_1, \dots, x_i\}) = i$ for all i . Hence $B_1 := \{x_1, \dots, x_{r(M)}\}$ is a basis of M which satisfies by construction that $|B_1 \cap A_i| = r(A_i)$.

The next step is to prove that any element $B_2 \in \mathcal{B}_p$ is in the right-hand side set of (3.2). As B_2 is a basis of M , we have that $|B_2 \cap A_i| \leq r(A_i) = |B_1 \cap A_i|$ for all i . Since $|B_2 \cap A_s| = |B_1 \cap A_s| = r(M)$, this implies that

$$|B_1 \cap (A_s \setminus A_{s-1})| \leq |B_2 \cap (A_s \setminus A_{s-1})|.$$

Now we use the basis exchange property to inductively replace elements of $B_2 \cap (A_s \setminus A_{s-1})$ by elements of $B_1 \cap (A_s \setminus A_{s-1})$. Note that we can really replace them by elements of $B_1 \cap (A_s \setminus A_{s-1})$ because replacing them by elements of $B_1 \cap A_{s-1}$ is impossible by the p -minimality of B_2 . This allows us to conclude that the above inequality is in fact an equality. But then $|B_2 \cap A_{s-1}| = |B_1 \cap A_{s-1}|$ and, after the above-described replacements have taken place, $B_2 \cap (A_s \setminus A_{s-1}) = B_1 \cap (A_s \setminus A_{s-1})$. Therefore, we can continue our procedure of exchanging elements and show inductively that $|B_2 \cap A_i| = |B_1 \cap A_i|$ for all i , which proves equality (3.2).

Now we need to show that the set \mathcal{B}_p satisfies the basis exchange property. So let $B_1, B_2 \in \mathcal{B}_p$ and $x \in B_1 \setminus B_2$. Let i be such that $x \in A_i \setminus A_{i-1}$ (where $A_0 := \emptyset$). We set

$$B_3 := (B_2 \cap A_i) \cup (B_1 \setminus A_i) \in \mathcal{B}_p$$

to be the basis that is obtained from B_2 by inductively exchanging elements of $(B_2 \setminus B_1) \setminus A_i$ of the highest p -weight (in this set) by an element of $B_1 \setminus B_2$ (which then has necessarily the same p -weight by the p -minimality of B_2). The basis exchange property of M and the p -minimality of B_1 imply that there is an $y \in (B_3 \cap (A_i \setminus A_{i-1})) \setminus B_1$ such that $(B_1 \setminus x) \cup y$ is in \mathcal{B} and, because it has the same p -weight as B_1 , also in \mathcal{B}_p . Since y is also in B_2 , this proves the claim. \square

Remark 3.1.14. Note that equality of sets (3.2) is equivalent to the statement that every p -minimal basis can be produced by the greedy algorithm (cf. [Oxl92, theorem 1.8.5, exercise 5 of section 1.8]).

Proposition 3.1.15. *The support of a matroid variety $B(M)$ is given by*

$$|B(M)| = \{p \in \mathbb{R}^n : M_p \text{ is (still) loopfree}\}.$$

PROOF. We use the notation of the proof of lemma 3.1.13. It is clear from the definition of a matroid fan that $p \in |B(M)|$ if and only if all A_i are flats in M .

If $p \in |B(M)|$, then all A_i are flats and we can choose a maximal chain of flats $\emptyset =: F_0 \subsetneq F_1 \subsetneq \dots \subsetneq F_{r(M)} := E$ of M that comprises all A_i . As for any choices $x_i \in F_i \setminus F_{i-1}$, the set $\{x_1, \dots, x_{r(M)}\}$ is a basis of M_p (cf. proof of lemma 3.1.13), we can conclude that every element of E is part of a basis of M_p ; hence M_p is loopfree.

If $p \notin |B(M)|$, then we can choose i such that A_i is not a flat and $x \in \text{cl}(A_i) \setminus A_i$. But then a basis B of M_p cannot contain x because otherwise $|B \cap \text{cl}(A_i)| > r(A_i)$, which is impossible. Hence x is a loop in M_p . \square

Remark 3.1.16. Let M be a matroid with loops $l_1, \dots, l_s \in E(M)$. Let $M \setminus \{l_1, \dots, l_s\}$ be the matroid which has ground set $E(M) \setminus \{l_1, \dots, l_s\}$ and whose bases are exactly the bases of M (note that this is a special case of the deletion operation we will introduce in definition 3.2.3). Then $B(M)$ can be regarded as the matroid fan $B(M \setminus \{l_1, \dots, l_s\})$ living in the boundary $x_{l_1} = \dots = x_{l_s} = -\infty$. We will not need this construction and refer to [Sha, definition 2.20] and [Mey10, proposition 4.25] instead. Note that without deleting the loops of M , definition 3.1.9 (adjusted by replacing the empty set by its closure $\{l_1, \dots, l_s\}$) would lead to a fan that is not balanced. Furthermore, the equality of supports in proposition 3.1.15 would obviously not hold.

Remark 3.1.17. The support of a matroid variety can also be described in terms of the circuits of the matroid: The support $|B(M)|$ is the set of points $p \in \mathbb{R}^n$ such that the maximum $\max\{p_i : i \in C\}$ is attained at least twice for every circuit C of the matroid. This has been shown in [MS, theorem 5.2.6].

Example 3.1.18. Let us consider uniform matroids $U_{k,n}$, the easiest class of matroids, in great detail: $U_{k,n}$ is the matroid whose ground set is $[n] := \{1, \dots, n\}$ and whose set of bases is $\{A \subseteq [n] : |A| = k\}$. It is easy to see that its rank function is $r_{U_{k,n}}(A) = \min\{|A|, k\}$ and its flats are $[n]$ and all subsets of $[n]$ which contain at most $k-1$ elements. A subset of $[n]$ is a circuit of $U_{k,n}$ if it has exactly k elements. The matroid $U_{k,n}$ is realisable as it can be obtained by choosing n generic vectors in \mathbb{C}^k in example 3.1.6. The maximal cones in $B(U_{k,n})$ are of the form $\langle \emptyset \subsetneq \{i_1\} \subsetneq \{i_1, i_2\} \subsetneq \dots \subsetneq \{i_1, i_2, \dots, i_{k-1}\} \subsetneq \{1, \dots, n\} \rangle$, where the i_j are pairwise distinct elements of $[n]$. In other words the maximal cones have the form

$$\{(x_1, \dots, x_n) \in \mathbb{R}^n : x_{i_1} \leq x_{i_2} \leq \dots \leq x_{i_{k-1}} \leq x_{p_1} = x_{p_2} = \dots = x_{p_{n-k+1}}\},$$

where $\{p_1, \dots, p_{n-k+1}\} = [n] \setminus \{i_1, \dots, i_{k-1}\}$. It is not hard to see that the map

$$B(U_{k,n}) \rightarrow L_{k-1}^{n-1} \times \mathbb{R}, (x_1, \dots, x_n) \mapsto ((x_1 - x_n, \dots, x_{n-1} - x_n), x_n)$$

is an isomorphism of tropical varieties. It is worth noticing that the fan structure $\mathcal{B}(U_{k,n})$ is much finer than the usual fan structure $\mathcal{L}_k^n \times \mathbb{R}$ of $L_k^n \times \mathbb{R}$.

Example 3.1.19. The following picture shows the matroid fan $\mathcal{B}(U_{3,4})$ (modulo its lineality space $\mathbb{R} \cdot (1, 1, 1, 1)$).

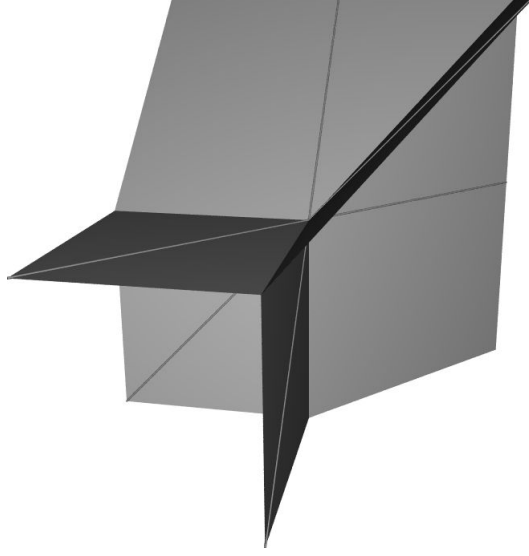

If $e_1 := (1, 0, 0, 0)$, then we have

$$\mathcal{B}_{M_{-e_1}} = \{\{1, 2, 3\}, \{1, 2, 4\}, \{1, 3, 4\}\}, \quad \mathcal{B}_{M_{e_1}} = \{\{2, 3, 4\}\};$$

so $-e_1$ is contained in $B(M)$, whereas e_1 is not (since 1 is a loop in M_{e_1}).

Next we want to use proposition 3.1.15 to show that a direct sum of matroids corresponds to a cross product of matroid varieties.

Lemma 3.1.20. *Let M, N be matroids. Then the two tropical varieties $B(M \oplus N)$ and $B(M) \times B(N)$ are equal.*

PROOF. The equality of the supports follows from the obvious equality of matroids

$$(M \oplus N)_{(p,q)} = M_p \oplus N_q.$$

As all occurring weights are 1, that also shows the equality of cycles. \square

Our next remark concerns the local structure of matroid varieties. It turns out that they locally (around each point) look like matroid varieties again.

Lemma 3.1.21. *Let $B(M)$ be a matroid variety and p a point in $B(M)$. Then we have*

$$\text{Star}_{B(M)}(p) = B(M_p).$$

PROOF. The statement follows from the obvious identity $M_{p+\epsilon v} = (M_p)_v$ for any vector $v \in \mathbb{R}^n$ and sufficiently small, positive ϵ . \square

Next we aim at showing that matroid varieties are irreducible. We do this by proving that they are locally irreducible and connected in codimension 1. Let us introduce some notation first.

Notation 3.1.22. Let $\mathcal{F} = (\emptyset = F_0 \subsetneq F_1 \subsetneq \dots \subsetneq F_{k-1} \subsetneq F_k = E)$ and $\mathcal{G} = (\emptyset = G_0 \subsetneq G_1 \subsetneq \dots \subsetneq G_{s-1} \subsetneq G_s = E)$ be chains of flats of a matroid M . If $\{F_1, \dots, F_k\} \subseteq \{G_1, \dots, G_s\}$, then we call \mathcal{F} a subchain (of flats) of \mathcal{G} and \mathcal{G} a superchain of \mathcal{F} . If F is a flat with $F_i \subsetneq F \subsetneq F_{i+1}$ for some i , then there is a unique way to add F to the chain \mathcal{F} ; we denote the resulting chain of flats by $\mathcal{F} \cup F$.

Lemma 3.1.23. *Every matroid variety $\mathcal{B}(M)$ is connected in codimension 1.*

PROOF. The equivalence relation on the set of facets of $\mathcal{B}(M)$

$$\sigma \sim \alpha \iff \sigma \text{ and } \alpha \text{ are connected via cones of codimension 1}$$

leads to the decomposition into equivalence classes $\mathcal{B}(M)^{(r(M))} = \dot{\cup}_{i=1}^k \mathcal{X}_i$. We turn the \mathcal{X}_i into weighted fans by assigning to each facet the trivial weight 1 and adding the appropriate lower dimension cones. By construction the fans \mathcal{X}_i fulfil the balancing condition and the sum of their associated cycles X_i is $\mathcal{B}(M)$. Let $\mathcal{Y} \in \{\mathcal{X}_1, \dots, \mathcal{X}_k, \mathcal{B}(M)\}$. We claim that the set of facets of $\max\{x_1, \dots, x_{|E|}\}^j \cdot \mathcal{Y}$ is

$$\{\langle \mathcal{F} \rangle \in \mathcal{Y} : \mathcal{F} = (\emptyset \subsetneq F_1 \subsetneq \dots \subsetneq F_{r(M)-j-1} \subsetneq E), F_i \text{ flat of rank } i \text{ in } M\},$$

each of them having weight 1. As plugging in $j = r(M) - 1$ shows that $k = 1$, this suffices to prove the lemma.

We show the claim by induction. Let $\mathcal{G} := (\emptyset =: G_0 \subsetneq G_1 \subsetneq \dots \subsetneq G_{r(M)-j-2} \subsetneq G_{r(M)-j-1} := E)$ be a chain of flats with $r(G_i) = i$ for $i \leq p$ and $r(G_i) = i + 1$ for $p + 1 \leq i \leq r(M) - j - 2$ such that $\langle \mathcal{G} \rangle \in \mathcal{Y}$. By the induction hypothesis the facets of $\max\{x_1, \dots, x_{|E|}\}^j \cdot \mathcal{Y}$ around $\langle \mathcal{G} \rangle$ correspond exactly to chains $\mathcal{G} \cup F$, where F is a flat with $G_p \subsetneq F \subsetneq G_{p+1}$. Recall that

$$\sum_{F \text{ flat with } G_p \subsetneq F \subsetneq G_{p+1}} V_F = V_{G_{p+1}} + (|F \text{ flat with } G_p \subsetneq F \subsetneq G_{p+1}| - 1) \cdot V_{G_p}.$$

As $\varphi := \max\{x_1, \dots, x_{|E|}\}$ is linear on the cones of \mathcal{Y} and satisfies $\varphi(V_F) = -1$ if $F = E$ and 0 otherwise, the weight of the cone $\langle \mathcal{G} \rangle$ in $\varphi^{j+1} \cdot \mathcal{Y}$ is

$$\begin{aligned} & \sum_{F \text{ flat with } G_p \subsetneq F \subsetneq G_{p+1}} \varphi(V_F) - \varphi \left(\sum_{F \text{ flat with } G_p \subsetneq F \subsetneq G_{p+1}} V_F \right) \\ &= -\varphi(V_{G_{p+1}}), \end{aligned}$$

which implies the claim. \square

Note that the previous proof also shows the following lemma as a byproduct:

Lemma 3.1.24. *Let M be a matroid of rank r on the set E . Let $L := \mathbb{R} \cdot (1, \dots, 1)$. Then $\max\{x_1, \dots, x_{|E|}\} \cdot \mathcal{B}(M) = \mathcal{B}(T(M))$, where the truncation $T(M)$ is the matroid obtained from M by removing all flats of rank $r - 1$ (i.e. $r_{T(M)}(A) = \min\{r_M(A), r - 1\}$). In particular, $\max\{x_1, \dots, x_{|E|}\}^{r-1} \cdot \mathcal{B}(M) = L$.*

Lemma 3.1.25. *Every matroid variety $\mathcal{B}(M)$ is locally irreducible and thus by lemma 3.1.23 also irreducible.*

PROOF. Let τ be a cone of codimension 1 in $\mathcal{B}(M)$ and let $\mathcal{F} = (\emptyset = F_0 \subsetneq F_1 \subsetneq \dots \subsetneq F_{r(M)-2} \subsetneq F_{r(M)-1} = E)$ be the corresponding chain of flats in M . Then there is a unique p such that $r(F_i) = i$ for $i \leq p$ and $r(F_i) = i + 1$ else. The facets of $\mathcal{B}(M)$ around τ correspond exactly to the chains of flats $\mathcal{F} \cup F$, with $F_p \subsetneq F \subsetneq F_{p+1}$. Let s be the number of such flats. As each element of $F_{p+1} \setminus F_p$ is contained in exactly one of these flats, we can conclude that $s - 1$ of the corresponding vectors are always linearly independent in V/V_τ . It follows that $\text{Star}_{\mathcal{B}(M)}(\tau)$ is isomorphic to L_1^{s-1} which is clearly irreducible. \square

Next we show that matroid varieties have degree 1.

Lemma 3.1.26. *Let $B(M)$ be a matroid variety of dimension r in \mathbb{R}^n . Then, we have $\max\{x_1, \dots, x_n, 0\}^r \cdot B(M) = 1 \cdot \{0\}$. In particular, matroid varieties have degree 1 (cf. definition 1.3.9).*

PROOF. We set $\varphi := \max\{x_1, \dots, x_n, 0\}$. In order to obtain a fan structure of $B(M)$ on whose cones φ is linear, we subdivide each cone $\langle \emptyset \subsetneq F_1 \subsetneq \dots \subsetneq F_p \subsetneq E \rangle \in \mathcal{B}(M)$ into cones

$$\langle V_{F_1}, \dots, V_{F_p}, V_E \rangle, \quad \langle V_{F_1}, \dots, V_{F_p} \rangle, \quad \langle V_{F_1}, \dots, V_{F_p}, -V_E \rangle,$$

and call the resulting fan structure \mathcal{X} . As $\varphi(V_F) = 0$ for all flats F of M , we have

$$\omega_{\varphi^r, \mathcal{X}}(\{0\}) = \omega_{\varphi^{r-1}, \mathcal{X}}(\langle -V_E \rangle) \cdot \varphi(-V_E) = \omega_{\varphi^{r-1}, \mathcal{X}}(\langle -V_E \rangle).$$

In order to prove that this weight is 1, we show by induction that for all $k \in \{1, \dots, r\}$

$$\omega_{\varphi^k, \mathcal{X}}(\langle V_{F_1}, \dots, V_{F_{r-k-1}}, -V_E \rangle) = \begin{cases} 1, & \text{if } r(F_i) = i \text{ for all } i \\ 0, & \text{else} \end{cases}.$$

Let $s \in \{1, \dots, r-k\}$ and let $(\emptyset =: F_0 \subsetneq F_1 \subsetneq \dots \subsetneq F_{r-k-1} \subsetneq F_{r-k} := E)$ be a chain of flats with $r(F_i) = i$ for $i \leq s-1$ and $r(F_i) = i+1$ for $s \leq i < r-k$. We set $\tau = \langle V_{F_1}, \dots, V_{F_{r-k-1}}, -V_E \rangle$ and see that the induction hypothesis implies that

$$\begin{aligned} & \omega_{\varphi^k, \mathcal{X}}(\langle V_{F_1}, \dots, V_{F_{r-k-1}}, -V_E \rangle) \\ &= \sum_{F_{s-1} \subsetneq F \subsetneq F_s} \omega_{\varphi^{k-1}, \mathcal{X}}(\tau + \langle V_F \rangle) \cdot \overbrace{\varphi(V_F)}^{=0} - \varphi_\tau \left(\sum_{F_{s-1} \subsetneq F \subsetneq F_s} \overbrace{\omega_{\varphi^{k-1}, \mathcal{X}}(\tau + \langle V_F \rangle) \cdot V_F}^{=1} \right) \\ &= -\varphi_\tau(V_{F_s}), \end{aligned}$$

where the sums run over flats F of M and $\tau + \langle V_F \rangle$ denotes the Minkowski sum of τ and the ray generated by V_F . But $-\varphi_\tau(V_{F_s}) = 1$ if $s = r-k$ and 0 otherwise. \square

Remark 3.1.27. There is another natural fan structure of matroid varieties, where two points $p, q \in B(M)$ are in the relative interior of the same cone if and only if $M_p = M_q$. The fan structure $\mathcal{B}(M)$ we use in this thesis was first introduced in [AK06] and is often called fine subdivision (or fine fan structure) because it is a refinement of the other fan structure (which in turn is called coarse subdivision). Note that it is an immediate consequence of equation (3.2) that M_p is constant in the relative interior of a cone of $\mathcal{B}(M)$ so that $\mathcal{B}(M)$ is indeed a refinement of the coarse fan structure. It is even true that the coarse subdivision is the coarsest fan structure of $B(M)$. In order to prove this, it suffices to show that for all codimension one cones $\langle \mathcal{F} \rangle \in \mathcal{B}(M)$ that are contained in exactly two facets $\langle \mathcal{F} \cup G_1 \rangle$ and $\langle \mathcal{F} \cup G_2 \rangle$ of $\mathcal{B}(M)$, the equality $M_p = M_{p+V_{G_1}} = M_{p+V_{G_2}}$ holds, where p is a point in the relative interior of $\langle \mathcal{F} \rangle$. Let $B \in \mathcal{B}_p$ and let F_s, F_{s+1} be the flats of \mathcal{F} such that $r_M(F_s) = s$, $r_M(F_{s+1}) = s+2$. By equation (3.2) we have $|B \cap F_s| = s$ and $|B \cap (F_{s+1} \setminus F_s)| = 2$. As $|B \cap G_i| \leq r_M(G_i) = s+1$ and $F_{s+1} \setminus F_s$ is a disjoint union of $G_1 \setminus F_s$ and $G_2 \setminus F_s$, it follows that $|B \cap G_1| = |B \cap G_2| = s+1$. This implies that, as required, $B \in \mathcal{B}_{p+V_{G_i}}$ for $i \in \{1, 2\}$.

Every matroid M can be decomposed into a direct sum $M = M_1 \oplus \dots \oplus M_k$ of connected submatroids which is unique up to reordering (cf. [Oxl92, corollary 4.2.13]). It follows from lemma 3.1.20 that the dimension of the (maximal) lineality space of $B(M)$ is greater or equal to the number of connected components k . Here, a lineality space L of a tropical cycle C in \mathbb{R}^n is a subspace of \mathbb{R}^n such that C is invariant under translations by vectors in L . We note that the maximal lineality space of a matroid variety is just the inclusion-minimal cone of its coarse subdivision and refer to section 3.4 for further terminology about lineality spaces. The next lemma states that equality holds.

Lemma 3.1.28. *Let M be a matroid on the ground set E and let $\mathcal{B}(M)$ be the corresponding matroid variety. Let L be its maximal lineality space. Then the equation*

$$\dim(L) = \text{number of connected components of } M$$

holds. In particular, if M is connected, then L is just spanned by $(1, \dots, 1)$.

PROOF. It clearly suffices to show that M is disconnected if $\dim(L) > 1$. So let us assume that L is more than the span of $(1, \dots, 1)$. Then L must contain some vector V_S with $\emptyset \subsetneq S \subsetneq E$. The fact that V_S is contained in the lineality space of $\mathcal{B}(M)$ means that $M_{\lambda V_S}$ stays the same for all $\lambda \in \mathbb{R}$; in particular, $M_{V_S} = M$. Hence all bases of M have the same V_S -weight, which means that they have the same number of elements in S (resp. $E \setminus S$). Therefore, $r(S) + r(E \setminus S) = r(M)$ which implies by [Ox192, proposition 4.2.1] that S is a separator (that is, a union of connected components). Hence M is disconnected. \square

3.2. Matroid quotients and rational functions

In this section we prove that any matroid variety which is a subcycle of another matroid variety can be cut out of the bigger matroid variety by a product of rational functions given in terms of the rank functions of the two matroids. We will see in the next section that the ability to do so constitutes the cornerstone to an intersection product of cycles on matroid varieties. The close connection between the matroid operations deletion and contraction and tropical modifications will be crucial in this section.

Remark 3.2.1. It follows straight from the definition that for two matroids M, N on the same ground set E we have

$$\{\text{flats of } N\} \subseteq \{\text{flats of } M\} \Rightarrow \mathcal{B}(N) \subseteq \mathcal{B}(M) \Rightarrow |\mathcal{B}(N)| \subseteq |\mathcal{B}(M)|.$$

As it is also clear that a vector which is in the support of a matroid variety and all of whose entries are either 0 or -1 must correspond to a flat of the matroid, we conclude

$$|\mathcal{B}(N)| \subseteq |\mathcal{B}(M)| \Leftrightarrow \mathcal{B}(N) \subseteq \mathcal{B}(M) \Leftrightarrow \{\text{flats of } N\} \subseteq \{\text{flats of } M\}.$$

In the following, we often write $\mathcal{B}(N) \subseteq \mathcal{B}(M)$ in this situation. We should notice that every matroid fan is a subfan of the matroid fan corresponding to the trivial matroid (whose only basis is E).

Lemma 3.2.2. *Let M and N be matroids of rank r resp. s such that $\mathcal{B}(N) \subseteq \mathcal{B}(M)$. Let $A \subseteq B$ be arbitrary subsets of E . Then the equation*

$$r_M(A) - r_N(A) \leq r_M(B) - r_N(B)$$

holds. Plugging in $A = \emptyset$ and $B = E$, we obtain

$$r_N(A) \leq r_M(A) \leq r_N(A) + r - s.$$

PROOF. As $\text{cl}_M(A) \subseteq \text{cl}_N(A)$ for any set A , we can assume that A and B are closed in M . By induction, we can also assume $r_M(B) - r_M(A) = 1$, i.e. $B = \text{cl}_M(A \cup x)$ for an element $x \in B \setminus A$. It follows that $\text{cl}_N(B) = \text{cl}_N(\text{cl}_M(A \cup x)) = \text{cl}_N(A \cup x)$; hence $r_N(B) - r_N(A) \leq 1$, which proves the claim. Another proof can be found in [Ox192, proposition 7.3.6]. \square

We will now see that there is a notion in matroid theory which captures containment of matroid varieties. This notion is based on the following standard constructions for matroids.

Definition 3.2.3. Let Q be a matroid on the set $E \dot{\cup} R$. Then the deletion $Q \setminus R$ is the matroid on E given by the rank function

$$r_{Q \setminus R}(A) = r_Q(A),$$

whereas the contraction Q/R is the (potentially not loopfree) matroid on E given by

$$r_{Q/R}(A) = r_Q(A \cup R) - r_Q(R).$$

Note that Q/R is loopfree if and only if R is a flat in Q . The next proposition describes both operations in terms of flats.

Proposition 3.2.4 ([Oxl92, proposition 3.3.1]).

- (1) F is a flat of Q/R if and only if $F \cup R$ is a flat of Q .
- (2) F is a flat of $Q \setminus R$ if and only if there is a flat F' in Q such that $F = F' \setminus R$.

Example 3.2.5. Recall that the rank function of the uniform matroid $U_{k,n}$ is given by $A \mapsto \min\{|A|, k\}$. By definition the deletion $U_{k,n} \setminus n$ is the matroid on the ground set $\{1, \dots, n-1\}$ with rank function

$$\{1, \dots, n-1\} \supseteq A \mapsto \min\{|A|, k\};$$

hence $U_{k,n} \setminus n = U_{k,n-1}$. The contraction $U_{k,n}/n$ has ground set $\{1, \dots, n-1\}$ and rank function

$$\{1, \dots, n-1\} \supseteq A \mapsto \min\{|A \cup n|, k\} - 1 = \min\{|A|, k-1\}.$$

Hence we have $U_{k,n}/n = U_{k-1,n-1}$. Note that the matroid variety corresponding to the contraction $B(U_{k,n}/n)$ is a subcycle of the matroid variety corresponding to the deletion $B(U_{k,n} \setminus n)$.

The next definition (following [Oxl92, section 7.3]) combines deletions and contractions.

Definition 3.2.6. Let M and N be matroids of rank r resp. s on the same ground set E . We call N a quotient of M if there are a set R and a matroid Q on the ground set $E \dot{\cup} R$ such that $M = Q \setminus R$ and $N = Q/R$. In this case, we have $r - s = r_Q(E) + r_Q(R) - r_Q(Q)$. Furthermore, if $r - s = 1$, we call N an elementary quotient of M .

The following proposition relates containment of matroid varieties to quotients.

Proposition 3.2.7. *The matroid variety $B(N)$ is a subcycle of $B(M)$ if and only if N is a quotient of M .*

PROOF. If N is a quotient of M , then it follows straight from the definitions that every flat of N is also closed in M . This proves one implication.

For the other direction, let us assume $B(N) \subseteq B(M)$. First, we fix a set R with $r - s$ elements. We define a matroid Q on $E \dot{\cup} R$ by assigning to each subset $I \dot{\cup} J \subseteq E \dot{\cup} R$ the rank

$$r_Q(I \dot{\cup} J) = \min\{r_M(I) + |J|, r_N(I) + r - s\}. \quad (3.3)$$

Using the inequalities of lemma 3.2.2 and plugging in $I \dot{\cup} \emptyset$, $I \dot{\cup} R$ and $\emptyset \dot{\cup} R$, we see that $Q \setminus R = M$ and $Q/R = N$.

It remains to check that r_Q is indeed a rank function. The first criterion is trivial, the second one follows from the corresponding property of r_M and r_N . As for the third criterion, for a given $A = I \dot{\cup} J$, we note that if adding an element x does not increase the first term of the minimum in equation (3.3), then it does not increase the second term either, as we have $r_N(I \cup x) - r_N(I) \leq r_M(I \cup x) - r_M(I)$ by lemma 3.2.2. So the third property follows from the respective property of r_N (if the minimum in equation (3.3) is attained in the second term) and r_M (otherwise). This finishes the proof. \square

Remark 3.2.8. Note that the matroid Q we constructed is minimal in the following sense: It is loopfree, R is independent and closed in Q and $r(Q) = r(M)$.

We divide the problem of finding rational functions that cut out $B(N)$ from $B(M)$ (if $B(N) \subsetneq B(M)$) into two parts: First we reduce it to the case that $r(M) = r(N) + 1$ by finding a chain of intermediate matroid varieties between the two matroid varieties. Thereafter, we give a rational function on $B(M)$ which cuts out $B(N)$.

We use proposition 3.2.7 to prove the following proposition.

Proposition 3.2.9. *Let M and N be matroids of rank r and s respectively such that $B(N) \subseteq B(M)$. For $i \in \{0, 1, \dots, r - s\}$ we define M_i to be the matroid on the ground set $E(M)$ whose rank function is given by*

$$r_{M_i}(A) := \min\{r_N(A) + i, r_M(A)\}.$$

Then the matroids M_i have the properties that $M_0 = N$, $M_{r-s} = M$, $r(M_i) = r(N) + i$ and $B(M_i) \subseteq B(M_{i+1})$.

PROOF. Let Q be the matroid we constructed in the previous proof (cf. (3.3)) and assume $R = \{1, \dots, r - s\}$. Then

$$M_i = (Q \setminus \{1, \dots, i\}) / \{i + 1, \dots, r - s\};$$

thus the M_i are indeed matroids. It is clear that $M_0 = N$, $M_{r-s} = M$ and one can read off the rank functions that $r(M_i) = r(N) + i$. One way to see that $B(M_i) \subseteq B(M_{i+1})$ is to use proposition 3.2.4 to conclude that

$$F \text{ flat of } M_i \Leftrightarrow \exists S \subseteq \{1, \dots, i\} \text{ such that } F \cup \{i + 1, \dots, r - s\} \cup S \text{ flat of } Q,$$

which implies that each flat of M_i is also a flat of M_{i+1} and therefore $B(M_i) \subseteq B(M_{i+1})$. \square

Remark 3.2.10. The matroid-theoretic counterpart of the above statement can be found in [Oxl92, proposition 7.3.5].

We next want to look into the geometric meaning of deletions and contractions in matroid theory. Therefore, let Q be a matroid on the set $E \dot{\cup} R$ and let $B(Q)$ be its matroid variety in $\mathbb{R}^{E \dot{\cup} R}$. Assume that R is a flat of Q (i.e. Q/R is loopfree) and that there exists a basis B of Q such that $R \cap B = \emptyset$ (i.e. $r(Q) = r(Q \setminus R)$). From that, we construct two tropical cycles in \mathbb{R}^E . First, the projection map $\pi_R : \mathbb{R}^{E \dot{\cup} R} \rightarrow \mathbb{R}^E$ produces the push-forward $(\pi_R)_*(B(Q))$. Second, we can take the closure of $B(Q)$ in $(\mathbb{R} \cup \{-\infty\})^{E \dot{\cup} R}$ and perform the intersection $\overline{B(Q)} \cap (\mathbb{R}^E \times \{-\infty\}^R)$ with a coordinate plane at infinity. In other words, a point $p \in \mathbb{R}^E$ is in $B(Q)^{\cap R}$ if and only if there is a real number λ_p (that depends on p) such that $(p, -\lambda, \dots, -\lambda)$ is in $B(Q)$ for all $\lambda \geq \lambda_p$. Let us denote the resulting set/cycle in \mathbb{R}^E by $B(Q)^{\cap R}$. Now, the following statement relates these geometric constructions to the matroid-theoretic notions of contraction and deletion.

Lemma 3.2.11. *With the notations and assumptions from above, we see that the deletion of R corresponds to projecting, i.e.*

$$B(Q \setminus R) = (\pi_R)_* B(Q),$$

and the contraction of R corresponds to intersecting with the appropriate coordinate hyperplane at infinity, i.e.

$$B(Q/R) = B(Q)^{\cap R}.$$

Moreover, the map $\pi_R : B(Q) \rightarrow B(Q \setminus R)$ is generically one-to-one, meaning that every point in the relative interior of a maximal cone of $B(Q \setminus R)$ has exactly one preimage under the morphism π_R .

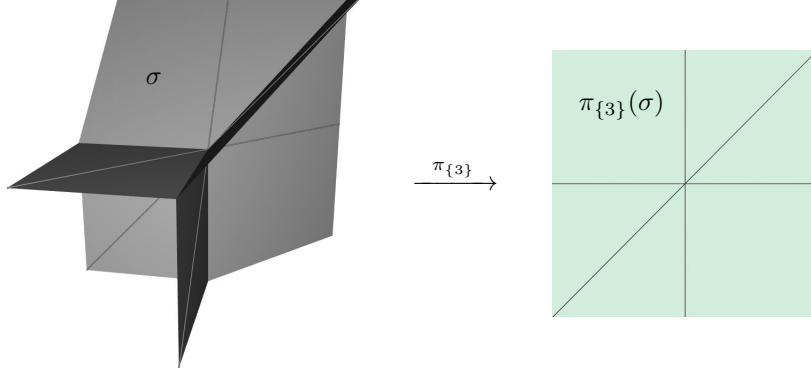

In the picture, $\sigma = \langle \emptyset \subsetneq \{1\} \subsetneq \{1, 4\} \subsetneq \{1, 2, 3, 4\} \rangle \in \mathcal{B}(U_{3,4})$ and $\pi_{\{3\}}(\sigma) = \langle \emptyset \subsetneq \{1\} \subsetneq \{1, 4\} \subsetneq \{1, 2, 4\} \rangle \in \mathcal{B}(U_{3,3})$.

PROOF. For the first equation, let σ be a cone in $\mathcal{B}(Q)$ and let $\mathcal{G} = (\emptyset \subsetneq G_1 \subsetneq \dots \subsetneq G_r = E \dot{\cup} R)$ be the corresponding chain of flats in Q . Then the projection of σ along π_R is obviously given by the chain \mathcal{F} with $F_i = G_i \setminus R$, which is a chain of flats in $Q \setminus R$. Note that it is possible that $F_{i+1} = F_i$ for some i , in which case projecting reduces the dimension of the cone σ . Hence $\pi_R(\sigma)$ is a cone in $\mathcal{B}(Q \setminus R)$. Furthermore, for any maximal chain \mathcal{F} of flats in $Q \setminus R$, there is exactly one “lifted” chain \mathcal{G} in Q , namely given by $G_i = \text{cl}_Q(F_i)$. Note that \mathcal{G} is maximal as $G_i \subsetneq G_{i+1}$ for all i and we assumed that Q and $Q \setminus R$ have the same rank. Thus for each maximal cone of $\mathcal{B}(Q \setminus R)$ there is exactly one maximal cone in $\mathcal{B}(Q)$ mapping to it (with trivial lattice index) and π_R is one-to-one over points in the relative interior of maximal cones in $\mathcal{B}(Q \setminus R)$.

For the second equation, we have the following chain of equivalences.

$$\begin{aligned}
p \in \mathcal{B}(Q)^{\cap R} &\Leftrightarrow (p, -\lambda, \dots, -\lambda) \in \mathcal{B}(Q) \text{ for large } \lambda \\
&\Leftrightarrow Q_{(p, -\lambda, \dots, -\lambda)} \text{ loopfree for large } \lambda \\
&\Leftrightarrow \text{for all } a \in E \text{ there exists a basis } B \text{ of } Q \text{ such that } a \in B, |B \cap R| = r_Q(R) \\
&\quad \text{and } B \cap E \text{ is } p\text{-minimal} \\
&\Leftrightarrow \text{for all } a \in E \text{ there exists a } p\text{-minimal basis } B' \text{ of } Q/R \text{ such that } a \in B' \\
&\Leftrightarrow (Q/R)_p \text{ loopfree} \Leftrightarrow p \in \mathcal{B}(Q/R)
\end{aligned}$$

In the middle step we use that bases B' of Q/R are exactly obtained as $B' = B \cap E$, where B is basis of Q with $|B \cap R| = r_Q(R)$. This can be easily seen from definition 3.2.3 and was proved in [Oxl92, corollary 3.1.9]. \square

We now turn to the case of elementary quotients. Using the above description we will see that they are in fact related to tropical modifications (cf. example 1.2.7). This observation was first made by Shaw in [Sha, proposition 2.22].

Proposition 3.2.12. *Let M and N be matroids of rank r resp. $r - 1$ such that $\mathcal{B}(N) \subseteq \mathcal{B}(M)$. Let Q be a matroid of rank r on $E \dot{\cup} \{e\}$ with $Q \setminus e = M$ and $Q/e = N$. (Note that Q exists by proposition 3.2.7.) Then $\mathcal{B}(Q)$ is a modification of $\mathcal{B}(M)$ along the divisor $\mathcal{B}(N)$. The modification function φ is linear on the cones of $\mathcal{B}(M)$ and satisfies*

$$\varphi(V_F) = r_N(F) - r_M(F),$$

for all flats F of M . This implies in particular that

$$\varphi \cdot \mathcal{B}(M) = \mathcal{B}(N).$$

PROOF. We know by proposition 3.2.4 and definition 3.2.3 that $\text{cl}_Q(F) \in \{F, F \cup e\}$ and $r_Q(F \cup e) - r_Q(F) = r_N(F) - r_M(F) + 1$ for all flats F of M . Let φ be as defined above. Our previous considerations allow us to conclude that

$$(V_F, \varphi(V_F)) = V_{\text{cl}_Q(F)} \in \mathbb{R}^{E \dot{\cup} \{e\}}.$$

Therefore, the graph of φ is contained in $B(Q)$. Let $\mathcal{G} = (\emptyset =: G_0 \subsetneq G_1 \subsetneq \dots \subsetneq G_{r(Q)} = E \dot{\cup} \{e\})$ be a maximal chain of flats in Q and let \mathcal{F} be the chain of flats in M obtained by intersecting each G_i with E . Let us first assume that $G_{i+1} \neq G_i \cup e$ for all i . Then \mathcal{F} is a maximal chain of flats in M and $\langle \mathcal{G} \rangle$ is the graph of the restriction of φ to $\langle \mathcal{F} \rangle$. Now we assume that we are in the opposite case and let i such that $G_{i+1} = G_i \cup e$. Then $\langle \mathcal{F} \rangle \in \mathcal{B}(M)$ has codimension 1 and $\langle \mathcal{G} \rangle \subseteq (\text{id} \times \varphi)(\langle \mathcal{F} \rangle) + (\{0\} \times \mathbb{R}_{\leq 0})$. This implies that $B(Q)$ is the tropical completion of the graph of φ (cf. remark 1.2.3 and example 1.2.7). Therefore, we can conclude by remark 1.2.3 and lemma 3.2.11 that

$$\varphi \cdot B(M) = B(Q)^{\cap e} = B(N).$$

□

Remark 3.2.13. It is not hard to use definition 1.2.2 to concretely compute the intersection product $\varphi \cdot B(M)$ of the previous proposition. However, the resulting alternative proof has the obvious disadvantage that it does not make clear the underlying geometric idea.

Example 3.2.14. Let M be a matroid with ground set E and recall that its truncation $T(M)$ is the matroid obtained by removing all flats of rank $r(M) - 1$ from M . Then the function φ of proposition 3.2.12 is linear on the cones of $\mathcal{B}(M)$ and satisfies $\varphi(V_E) = -1$ and $\varphi(V_F) = 0$ for all other flats of M . Since φ is equal to the rational function $\max\{x_1, \dots, x_{|E|}\}$, this gives an alternative proof of lemma 3.1.24.

Let us now collect the results of propositions 3.2.9 and 3.2.12 in the following important corollary.

Corollary 3.2.15. *Let M, N be matroids such that $B(N)$ is a codimension k subcycle of $B(M)$. For $i \in \{1, \dots, k\}$ let φ_i be the rational function which is linear on the cones of $\mathcal{B}(M)$ and satisfies*

$$\varphi_i(V_F) = \begin{cases} -1, & \text{if } r_M(F) - r_N(F) \geq i \\ 0, & \text{else} \end{cases},$$

for all flats of M . Then we have

$$\varphi_1 \cdots \varphi_k \cdot B(M) = B(N).$$

3.3. The intersection product on matroid varieties

This section is devoted to defining an intersection product of cycles on matroid varieties and showing that it does not depend on the chosen functions representing the diagonal and has the expected properties. For some special cases we express the intersection product of two matroid varieties on a third matroid variety in terms of the rank functions of the three matroids. There is not much hope to do that in general as we cite examples of intersections of matroid varieties that are not again matroid varieties.

First we use the results of the previous section to find rational functions cutting out the diagonal $\Delta_{B(M)}$ in the product $B(M) \times B(M)$. The only thing which is left to do is to observe that both $\Delta_{B(M)}$ and $B(M) \times B(M)$ are indeed matroid varieties. We know already from lemma 3.1.20 that $B(M) \times B(M) = B(M \oplus M)$. Next, we give the necessary definition concerning the diagonal $\Delta_{B(M)}$. As usually, $\Delta_{B(M)}$ denotes the push-forward of $B(M)$ along the map $B(M) \rightarrow B(M) \times B(M)$, $x \mapsto (x, x)$.

Definition 3.3.1. Let M be a matroid on the set E . We define Δ_M to be the matroid having the ground set $E \dot{\cup} E$ and the rank function $r_{\Delta_M}(A \dot{\cup} B) := r_M(A \cup B)$.

It is easy to see that r_{Δ_M} satisfies the axioms of a rank function and that

$$\{F \dot{\cup} F : F \text{ flat in } M\}$$

is the set of flats in Δ_M . Therefore, $|\mathcal{B}(\Delta_M)| = |\Delta_{\mathcal{B}(M)}|$, and we can conclude that the cycles

$$\mathcal{B}(\Delta_M) = \Delta_{\mathcal{B}(M)}$$

are equal. Now we are ready to state the following main result which is a direct consequence of corollary 3.2.15.

Corollary 3.3.2. Let M be a matroid of rank r . For $i \in \{1, \dots, r\}$ let φ_i be the function that is linear on the cones of $\mathcal{B}(M \oplus M)$ and satisfies

$$\varphi_i(V_F) = \begin{cases} -1, & \text{if } r_M(A) + r_M(B) - r_M(A \cup B) \geq i \\ 0, & \text{else} \end{cases},$$

for all flats $F = A \dot{\cup} B$ of $M \oplus M$. Then the rational functions $\varphi_1, \dots, \varphi_r \in \mathbb{R}(\mathcal{B}(M) \times \mathcal{B}(M))$ cut out the diagonal $\Delta_{\mathcal{B}(M)}$, i.e.

$$\Delta_{\mathcal{B}(M)} = \varphi_1 \cdots \varphi_r \cdot \mathcal{B}(M) \times \mathcal{B}(M).$$

As an immediate consequence of this fact, in complete analogy to [AR10, definition 9.3] and [All12, definition 1.16], we can now define an intersection product of cycles in matroid varieties.

Definition 3.3.3. Let M be a matroid of rank r and let C, D be subcycles of $\mathcal{B}(M)$ of codimension s and p . We define the intersection product $C \cdot D \in Z_{r-s-p}(\mathcal{B}(M))$ of the cycles C and D in $\mathcal{B}(M)$ as

$$C \cdot D = \pi_*(\varphi_r \cdots \varphi_1 \cdot C \times D),$$

where the φ_i are the rational functions of the previous corollary and $\pi : \mathcal{B}(M) \times \mathcal{B}(M) \rightarrow \mathcal{B}(M)$ is the projection to the first factor.

Note that here and in the following, we a priori stick to the definition of the functions φ_i in corollary 3.3.2. However, we will see later that the definition is independent of all choices.

Remark 3.3.4. The intersection product of the previous definition has been implemented for some cases in [Ham]. However, the number of maximal cones of the matroid fan $\mathcal{B}(M \oplus M)$ on which the rational functions φ_i are defined grows very fast with the rank of M . Looking for a more economical way of implementing intersection products of cycles is therefore an active field of research.

Example 3.3.5. We compute the self-intersection in $\mathcal{B}(U_{3,4})$ of the matroid variety associated to the matroid N whose flats are $\emptyset, \{1, 2\}, \{3, 4\}, \{1, 2, 3, 4\}$. The functions $\varphi_1, \varphi_2, \varphi_3$ are linear on the cones of $\mathcal{B}(U_{3,4} \oplus U_{3,4})$ and are given on the vectors corresponding to flats F of $U_{3,4} \oplus U_{3,4}$ by

$$\varphi_3(V_F) = \begin{cases} -1, & \text{if } F = E \dot{\cup} E \\ 0, & \text{else} \end{cases},$$

$$\varphi_2(V_F) = \begin{cases} -1, & \text{if } F \in \{A \dot{\cup} E : |A| \geq 2\} \cup \{E \dot{\cup} A : |A| \geq 2\} \cup \{A \dot{\cup} A : |A| = 2\} \\ 0, & \text{else} \end{cases},$$

$$\varphi_1(V_F) = \begin{cases} -1, & \text{if } F \in \{A \dot{\cup} B : (|A|, |B| \geq 1, (A \subseteq B \text{ or } B \subseteq A)) \text{ or } |A|, |B| \geq 2\} \\ 0, & \text{else} \end{cases}.$$

As $\mathcal{B}(N \oplus N)$ is a subfan of $\mathcal{B}(U_{3,4} \oplus U_{3,4})$ the functions φ_i are also linear on the cones of $\mathcal{B}(N \oplus N)$. Now it is easy to see that $\varphi_3 \cdot \mathcal{B}(N \oplus N)$ consists of cones $\langle \emptyset \subsetneq F_1 \subsetneq F_2 \subsetneq E \dot{\cup} E \rangle$, with $r_{N \oplus N}(F_i) = i$ (all of them having weight 1). If $F = A \dot{\cup} B$ is a flat in $N \oplus N$, then the weight of the cone $\sigma_F := \langle \emptyset \subsetneq F \subsetneq E \dot{\cup} E \rangle$ in $\varphi_2 \cdot \varphi_3 \cdot \mathcal{B}(N \oplus N)$ is

$$\begin{aligned} \omega_{\varphi_2 \cdot \varphi_3}(\sigma_F) &= \begin{cases} \varphi_2(V_{(A \cup B) \dot{\cup} (A \cup B)}) - \varphi_2(V_{E \dot{\cup} E}), & \text{if } \{r_N(A), r_N(B)\} = \{0, 1\} \\ -\varphi(V_F), & \text{if } r_{N \oplus N}(F) = 2 \end{cases} \\ &= \begin{cases} 1, & \text{if } A = B \in \{\{1, 2\}, \{3, 4\}\} \\ 0, & \text{else} \end{cases}. \end{aligned}$$

Finally, the weight of $\mathbb{R} \cdot V_{E \dot{\cup} E}$ in $\varphi_1 \cdot \varphi_2 \cdot \varphi_3 \cdot \mathcal{B}(N \oplus N)$ is

$$\begin{aligned} \omega_{\varphi_1 \cdot \varphi_2 \cdot \varphi_3 \cdot \mathcal{B}(N \oplus N)}(\mathbb{R} \cdot V_{E \dot{\cup} E}) &= \varphi_1(V_{\{1,2\} \dot{\cup} \{1,2\}}) + \varphi_1(V_{\{3,4\} \dot{\cup} \{3,4\}}) - \varphi_1(V_{E \dot{\cup} E}) \\ &= -1 - 1 - (-1) = -1. \end{aligned}$$

Taking the push-forward we obtain that $B(N) \cdot_{B(U_{3,4})} B(N)$ is (the cycle associated to) $\mathbb{R} \cdot (1, 1, 1, 1)$ with weight (-1) .

We need the following lemma to prove the basic properties of the intersection product.

Lemma 3.3.6. *Let C, D be cycles in $B(M)$. Then $\varphi_r \cdots \varphi_1 \cdot C \times D$ is a subcycle of $\Delta_{B(M)}$. In particular, the definition of $C \cdot D$ does not depend on the chosen projection.*

PROOF. We prove by induction over k that

$$|\varphi_k \cdots \varphi_1 \cdot C \times D| \subseteq |\varphi_k \cdots \varphi_1 \cdot B(M) \times B(M)|.$$

for all $k = 1, \dots, r$, where the case $k = r$ proves the claim. It is clear that

$$|\varphi_k \cdot \varphi_{k-1} \cdots \varphi_1 \cdot C \times D| \subseteq |\varphi_k|_{|\varphi_{k-1} \cdots \varphi_1 \cdot C \times D|},$$

where the right-hand side is the locus of non-linearity of the restriction of φ_k to the support of $\varphi_{k-1} \cdots \varphi_1 \cdot C \times D$. By the induction hypothesis, the right-hand side is contained in

$$|\varphi_k|_{|\varphi_{k-1} \cdots \varphi_1 \cdot B(M) \times B(M)|}.$$

Since $\varphi_{k-1} \cdots \varphi_1 \cdot B(M) \times B(M)$ is a matroid variety, and hence locally irreducible, it follows by proposition 1.2.11 that

$$|\varphi_k|_{|\varphi_{k-1} \cdots \varphi_1 \cdot B(M) \times B(M)|} = |\varphi_k \cdots \varphi_1 \cdot B(M) \times B(M)|.$$

□

Theorem 3.3.7. *For all subcycles C, D, E of $B(M)$, the following properties hold:*

- (1) $|C \cdot D| \subseteq |C| \cap |D|$.
- (2) *If C and D are fan cycles, then $C \cdot D$ is a fan cycle, too.*
- (3) $(h \cdot C) \cdot D = h \cdot (C \cdot D)$ for any cocycle h on C .
- (4) $C \cdot B(M) = C$.
- (5) $C \cdot D = D \cdot C$.
- (6) *If $C = h \cdot B(M)$ for some cocycle h , then $C \cdot D = h \cdot D$.*
- (7) $(C \cdot D) \cdot E = C \cdot (D \cdot E)$.
- (8) $(C + D) \cdot E = C \cdot E + D \cdot E$.

PROOF. (1) follows directly from lemma 3.3.6. Everything else except (4) can be deduced in the same way as in the \mathbb{R}^r -case (cf. [Rau09, 1.5.2, 1.5.5, 1.5.6, 1.5.9] or [AR10, section 9]), namely: (2) follows from the fact that the φ_i are rational fan functions. (3) follows from part three and four of proposition 2.3.9. The symmetry of the functions φ_i and lemma 3.3.6 imply

$$C \cdot D = \pi_{1*}(\varphi_1 \cdots \varphi_r \cdot C \times D) = \pi_{2*}(\varphi_1 \cdots \varphi_r \cdot D \times C) = \pi_{1*}(\varphi_1 \cdots \varphi_r \cdot D \times C) = D \cdot C,$$

where $\pi_i : B(M) \times B(M) \rightarrow B(M)$ is the projection to the i -th factor. (6) is a direct consequence of (3) and (4). The proof of (7) is completely analogous to [Rau09, proposition 1.5.9] and (8) is obvious.

It remains to prove (4). By (8) it suffices to prove (4) for irreducible cycles C . We know by (1) that $|C \cdot B(M)| \subseteq |C|$; hence the irreducibility of C implies that $C \cdot B(M) = \lambda_C \cdot C$ for some $\lambda_C \in \mathbb{Z}$. We first note that the factors λ_P are the same for every point P in $B(M)$: For any point P , the recession fan of $P \times B(M)$ is $\{0\} \times B(M)$; thus we know by proposition 1.4.10 that

$$\lambda_P = \deg(\varphi_r \cdots \varphi_1 \cdot P \times B(M)) = \deg(\varphi_r \cdots \varphi_1 \cdot \{0\} \times B(M)) = \lambda_{\{0\}}.$$

Now we use lemma 2.1.19 to choose a cocycle $h \in C^{\dim C}(C)$ such that $h \cdot C \neq 0$. Then (3) implies that

$$\lambda_C \cdot (h \cdot C) = h \cdot (C \cdot B(M)) = (h \cdot C) \cdot B(M) = \lambda_{\{0\}} \cdot (h \cdot C).$$

Hence $\lambda_C = \lambda_{\{0\}}$ for all cycles C . As $\lambda_{B(M)} = 1$, it follows that $C \cdot B(M) = C$ for every subcycle C . \square

Remark 3.3.8. It follows from theorem 3.3.7 (6) that our intersection product is independent of the choice of cocycle describing the diagonal $\Delta_{B(M)}$, as each intersection product can be calculated as

$$C \cdot D = \pi_*(\Delta_{B(M)} \cdot C \times D),$$

where the right-hand side is the push-forward of an intersection product of cycles on $B(M \oplus M)$.

The previous remark will be crucial for the proofs of the next lemmas concerning the behaviour of our intersection product under automorphisms, cross products and locality.

Lemma 3.3.9. *Let $\alpha : B(M) \rightarrow B(M')$ be an isomorphism of matroid varieties and let C and D be two arbitrary cycles in $B(M)$. Then the following equation holds:*

$$\alpha_*(C \cdot D) = \alpha_* C \cdot \alpha_* D.$$

PROOF. If C is cut out by a cocycle, i.e. $C = h \cdot B(M)$, then the claim follows from theorem 3.3.7 (6) and the projection formula (proposition 2.3.9) as

$$\alpha_*(C \cdot D) = \alpha_*(\alpha^*(\alpha^{-1})^* h \cdot D) = (\alpha^{-1})^* h \cdot \alpha_* D,$$

and

$$\alpha_* C = \alpha_*(h \cdot \alpha_*^{-1} B(M')) = (\alpha^{-1})^* h \cdot B(M').$$

We apply this to $\beta := \alpha \times \alpha$ (the corresponding isomorphism between $B(M) \times B(M)$ and $B(M') \times B(M')$) and the cycles $\Delta_{B(M)}$ and $C \times D$. By the previous remark, this suffices to prove the claim. \square

Lemma 3.3.10. *Let A_1, B_1 be cycles in $B(M_1)$ and let A_2, B_2 be cycles in $B(M_2)$. Then*

$$(A_1 \times A_2) \cdot (B_1 \times B_2) = (A_1 \cdot B_1) \times (A_2 \cdot B_2).$$

PROOF. For $i \in \{1, 2\}$ let h_i be a piecewise polynomial satisfying $h_i \cdot B(M_i) \times B(M_i) = \Delta_{B(M_i)}$ (cf. corollary 3.3.2). Let $\pi_i : B(M_1) \times B(M_2) \times B(M_1) \times B(M_2) \rightarrow B(M_i) \times B(M_i)$ be the projection to the respective factors. Then

$$\pi_1^* h_1 \cdot \pi_2^* h_2 \cdot B(M_1) \times B(M_2) \times B(M_1) \times B(M_2) = \Delta_{B(M_1) \times B(M_2)}.$$

Remark 3.3.8 allows us to use the function $\pi_1^* h_1 \cdot \pi_2^* h_2$ in the definition of the intersection product, which clearly implies the claim. \square

Lemma 3.3.11. *Let C, D be subcycles of the matroid variety $B(M)$. Then we have*

$$\text{Star}_{C \cdot D}(p) = \text{Star}_C(p) \cdot \text{Star}_D(p),$$

where $p \in |C| \cap |D|$ and the right-hand side is an intersection product of cycles in $B(M_p)$.

PROOF. Let h be a piecewise polynomial on $B(M) \times B(M)$ that cuts out the diagonal $\Delta_{B(M)}$ (cf. corollary 3.3.2). The locality of intersecting with piecewise polynomials (remark 2.1.22) implies that $h^{(p,p)} \in \text{PP}^{r(M)}(B(M_p) \times B(M_p))$ cuts out the cycle $\text{Star}_{\Delta_{B(M)}}(p, p) = \Delta_{B(M_p)}$. Using the piecewise polynomial $h^{(p,p)}$ to define the intersection product on $B(M_p)$ (which we are allowed to do by remark 3.3.8) we see that the claim is a direct consequence of the locality of intersecting with piecewise polynomials. \square

The following example illustrates that the ability to cut out the diagonal does not necessarily lead to a well-defined intersection product having the properties listed in theorem 3.3.7.

Example 3.3.12. Let $\{e_1, e_2\}$ be the standard basis of \mathbb{R}^2 and let $X = \mathbb{R} \cdot e_1 + \mathbb{R} \cdot e_2$ be the sum (as tropical cycles) of the coordinate axes. Let \mathcal{Y} be the fan structure of $X \times X$ consisting of maximal cones

$$\left\langle \left(\begin{array}{c} a \\ 0 \end{array} \right), \left(\begin{array}{c} a \\ a \end{array} \right) \right\rangle, \left\langle \left(\begin{array}{c} 0 \\ a \end{array} \right), \left(\begin{array}{c} a \\ a \end{array} \right) \right\rangle, \left\langle \left(\begin{array}{c} a \\ 0 \end{array} \right), \left(\begin{array}{c} 0 \\ b \end{array} \right) \right\rangle,$$

with $a, b \in \{e_1, -e_1, e_2, -e_2\}$, $a \neq b$. Note that \mathcal{Y} contains the diagonal. Let φ be the function which is linear on the cones of \mathcal{Y} and maps

$$\left(\begin{array}{c} e_1 \\ 0 \end{array} \right), \left(\begin{array}{c} 0 \\ e_1 \end{array} \right), \left(\begin{array}{c} e_1 \\ e_1 \end{array} \right) \mapsto 1, \quad \left(\begin{array}{c} -e_1 \\ -e_1 \end{array} \right), \pm \left(\begin{array}{c} e_2 \\ e_2 \end{array} \right) \mapsto -1,$$

and all other rays of \mathcal{Y} to 0. A straightforward computation shows that $\varphi \cdot X \times X = \Delta_X$. Let $X_1 = \mathbb{R} \cdot e_1$. Then another computation shows that

$$\varphi \cdot X \times X_1 = \mathbb{R} \cdot \left(\begin{array}{c} e_1 \\ e_1 \end{array} \right) + \mathbb{R} \cdot \left(\begin{array}{c} e_2 \\ 0 \end{array} \right),$$

which is not a subcycle of Δ_X . We see that the intersection product depends on the chosen projection and is not commutative. If ψ is the function defined in the same way as φ but with the roles of e_1 and e_2 interchanged, then ψ also cuts out the diagonal. As

$$\psi \cdot X \times X_1 = - \left(\mathbb{R} \cdot \left(\begin{array}{c} e_1 \\ 0 \end{array} \right) \right) + \mathbb{R} \cdot \left(\begin{array}{c} e_1 \\ e_1 \end{array} \right),$$

we see that the intersection product on X depends on the function which cuts out the diagonal. Depending on the various choices, the intersection product of X and X_1 on X could be X , X_1 or \emptyset .

Let us have a look at two more examples.

Example 3.3.13. Let N be the matroid of rank 3 on the ground set $E = \{1, 2, 3, 4, 5, 6\}$ whose rank 1 flats are exactly the 1-element subsets of E and whose flats of rank 2 are $\{1, 2\}, \{3, 4\}, \{5, 6\}, \{1, 3, 5\}, \{1, 4, 6\}, \{2, 3, 6\}, \{2, 4, 5\}$. We would like to compute the self-intersection of $B(N)$ in the ambient cycle $B(U_{4,6})$. The easiest way to do so is to use

proposition 3.2.12 to find a rational function which cuts out $B(N)$ from $B(U_{4,6})$; we can then use that function to compute our intersection product (see part (5) of theorem 3.3.7): The rational function φ of proposition 3.2.12 is linear on the cones of $\mathcal{B}(U_{4,6})$ and satisfies for all flats F of $U_{4,6}$ that

$$\varphi(V_F) = \begin{cases} -1, & \text{if } F \in \{\{1, 3, 5\}, \{1, 4, 6\}, \{2, 3, 6\}, \{2, 4, 5\}, \{1, 2, 3, 4, 5, 6\}\} \\ 0, & \text{else} \end{cases}.$$

For a flat F of N , we set $\sigma_F := \langle \emptyset \subsetneq F \subsetneq E \rangle$. We compute

$$\omega_{\varphi \cdot B(N)}(\sigma_{\{1\}}) = \varphi(V_{\{1,2\}}) + \varphi(V_{\{1,3,5\}}) + \varphi(V_{\{1,4,6\}}) - \varphi(V_E) = 0 - 1 - 1 - (-1) = -1,$$

and

$$\omega_{\varphi \cdot B(N)}(\sigma_{\{1,2\}}) = \varphi(V_{\{1\}}) + \varphi(V_{\{2\}}) - \varphi(V_{\{1,2\}}) = 0 + 0 - 0 = 0,$$

as well as

$$\omega_{\varphi \cdot B(N)}(\sigma_{\{1,3,5\}}) = \varphi(V_{\{1\}}) + \varphi(V_{\{3\}}) + \varphi(V_{\{5\}}) - \varphi(V_{\{1,3,5\}}) = 0 + 0 + 0 - (-1) = 1.$$

For symmetry reasons it follows that (a fan structure of) $B(N) \cdot_{B(U_{4,6})} B(N) = \varphi \cdot B(N)$ consists of the cones $\sigma_{\{i\}}$ of weight -1 , where $i \in \{1, \dots, 6\}$ and σ_F of weight 1, where F is in $\{\{1, 3, 5\}, \{1, 4, 6\}, \{2, 3, 6\}, \{2, 4, 5\}\}$.

Example 3.3.14. Let M be a matroid of rank 3. Every subset $\{F_1, \dots, F_k\}$ of flats of M such that $E(M)$ is the disjoint union of the F_i gives rise to a codimension 1 matroid variety $B(N) \subsetneq B(M)$. In fact every codimension 1 matroid subvariety of $B(M)$ is given by such a choice of flats of M . The function φ which is linear on the cones of $\mathcal{B}(M)$ and satisfies $\varphi(V_F) = r_N(F) - r_M(F)$ for all flats F of M cuts out $B(N)$ from $B(M)$. Therefore, the self-intersection of $B(N)$ in $B(M)$ is

$$\varphi \cdot B(N) = \left(\sum_{i=1}^k \varphi(V_{F_i}) - \varphi(V_{E(M)}) \right) \cdot L = (1 - |\{i : r_M(F_i) = 2\}|) \cdot L,$$

where L denotes the lineality space $\mathbb{R} \cdot (1, \dots, 1)$.

Remark 3.3.15. In [Spe08, proposition 3.1, theorem 3.6], Speyer gives the following matroid-theoretic description of the intersection of two matroid varieties $B(N)$ and $B(N')$ in the ambient cycle \mathbb{R}^n . The matroid intersection $N \wedge N'$ (defined in [Whi86, section 7.6]) is the matroid whose bases are the minimal sets in

$$\{B \cap B' : B \text{ basis of } N, B' \text{ basis of } N'\}.$$

If r, s are the ranks of N, N' , then the rank of $N \wedge N'$ is greater or equal to $r + s - n$ and equality is attained if and only if there exist bases B, B' of N, N' satisfying $B \cup B' = [n]$. Then the intersection product of $B(N)$ and $B(N')$ in \mathbb{R}^n is

$$B(N) \cdot_{\mathbb{R}^n} B(N') = \begin{cases} B(N \wedge N'), & \text{if the rank of } N \wedge N' \text{ is } r + s - n, \\ \emptyset, & \text{otherwise.} \end{cases}$$

We have seen in examples 3.3.5, 3.3.13 and 3.3.14 that the intersection of two matroid varieties in a third matroid variety is in general not again a matroid variety. We would like to have a matroid-theoretic description of such an intersection product in the case that it is a matroid variety. The closest thing we have is the following proposition.

Proposition 3.3.16. Let $B(N_1), B(N_2)$ be two subcycles of a matroid variety $B(M)$. Assume that $r(N_2) = r(M) - 1$. For any set $A \subseteq E$ we set

$$r_K(A) := r_{N_1}(A) + r_{N_2}(\text{cl}_{N_1}(A)) - r_M(\text{cl}_{N_1}(A)).$$

Then the following hold:

(1) If r_K is the rank function of a matroid K , then

$$B(N_1) \cdot_{B(M)} B(N_2) = \begin{cases} B(K), & \text{if } K \text{ is loopfree} \\ \emptyset, & \text{else} \end{cases}.$$

(2) If r_K is not a rank function, then $B(N_1) \cdot_{B(M)} B(N_2)$ has a cone of negative weight.

PROOF. We know by theorem 3.3.7 that $B(N_1) \cdot_{B(M)} B(N_2) = \varphi \cdot B(N_1)$, where φ is linear on the cones of $B(M)$ and satisfies $\varphi(V_F) = r_{N_2}(F) - r_M(F)$ for all flats F of M (cf. proposition 3.2.12). For a flat F of N_1 , we have thus

$$r_K(F) = r_{N_1}(F) + \varphi(V_F).$$

We first assume that r_K is a rank function. Let $\mathcal{F} = (\emptyset \subsetneq F_1 \subsetneq \dots \subsetneq F_{r(N_1)-2} \subsetneq E)$ be a chain of flats in N_1 . Then there is a unique p such that $r_{N_1}(F_i) = i$ for $i \leq p$ and $r_{N_1}(F_i) = i + 1$ else.

If $\varphi(V_{F_p}) = -1$ or $\varphi(V_{F_{p+1}}) = 0$, then $\langle \mathcal{F} \rangle$ has weight 0 in $\varphi \cdot B(N_1)$ (cf. lemma 3.2.2). As in this case $r_K(F_{p+1}) = r_K(F_p) + 2$, there must be two consecutive flats in \mathcal{F} which have the same rank in K ; therefore, \mathcal{F} is not a chain of flats in K .

So it remains to consider the case that $\varphi(V_{F_p}) = 0$ and $\varphi(V_{F_{p+1}}) = -1$. Then the weight of $\langle \mathcal{F} \rangle$ in $\varphi \cdot B(N_1)$ is

$$\omega_{\varphi \cdot B(N_1)}(\langle \mathcal{F} \rangle) = 1 - |\{F : F_p \subsetneq F \subsetneq F_{p+1} \text{ flat in } N_1 \text{ with } \varphi(V_F) = -1\}|.$$

We claim that $\omega_{\varphi \cdot B(N_1)}(\langle \mathcal{F} \rangle) \in \{0, 1\}$: Otherwise there were two distinct flats $F_p \subsetneq F, G \subsetneq F_{p+1}$ in N_1 with $r_K(F) = r_K(G) = r_K(F_p) = p$. As $r_K(F \cup G) = r_K(F_{p+1}) = p + 1$, this contradicts our assumption that r_K is a rank function. It remains to show that

$$\omega_{\varphi \cdot B(N_1)}(\langle \mathcal{F} \rangle) = 1 \Leftrightarrow \mathcal{F} \text{ is a chain of flats in } K.$$

If \mathcal{F} is a chain of flats in K , then F_p is a flat in K which implies that $r_K(F) = r_K(F_p) + 1$ for all flats F of N_1 with $F_p \subsetneq F \subsetneq F_{p+1}$; hence $\varphi(V_F) = 0$ and $\omega_{\varphi \cdot B(N_1)}(\langle \mathcal{F} \rangle) = 1$.

If \mathcal{F} is not a chain of flats in K , then there is an $i \leq p$ such that F_i is not closed in K (because one can easily read off r_K that for $i \geq p + 1$ all F_i are flats in K). We choose x such that $x \in \text{cl}_K(F_i) \setminus F_i$. Then $\varphi(V_{\text{cl}_{N_1}(F_i \cup x)}) = -1$, which implies that $\varphi(V_{\text{cl}_{N_1}(F_p \cup x)}) = -1$. Note that this also implies that $x \notin F_p$ because $\varphi(V_{F_p}) = 0$. Since $\text{cl}_K(F_i \cup x) \subseteq \text{cl}_K(F_{p+1}) = F_{p+1}$ we conclude that $F_p \subsetneq \text{cl}_{N_1}(F_p \cup x) \subsetneq F_{p+1}$ is a flat of N_1 . Therefore, $\omega_{\varphi \cdot B(N_1)}(\langle \mathcal{F} \rangle) = 0$. This proves (1) as \mathcal{F} is never a chain of flats in K if K has loops because in that case \emptyset is not a flat of K .

Let us show (2). It is clear that r_K satisfies the first property of a rank function. The assumption that $r(N_2) = r(M) - 1$ ensures that it also fulfils the second property. If r_K is not a rank function, then we can choose a flat F of N_1 and $x, y \in E$ such that $r_K(F \cup x) = r_K(F \cup y) = r_K(F)$ and $r_K(F \cup x \cup y) = r_K(F) + 1$. We choose a chain $\mathcal{F} = (\emptyset \subsetneq F_1 \subsetneq \dots \subsetneq F_{r(N_1)-2} \subsetneq E)$ of flats in N_1 with $F_p := F, F_{p+1} := \text{cl}_{N_1}(F \cup x \cup y), r_{N_1}(F_i) = i$ for $i \leq p$ and $r_{N_1}(F_i) = i + 1$ otherwise. Then

$$\omega_{\varphi \cdot B(N_1)}(\langle \mathcal{F} \rangle) \leq \varphi(V_{\text{cl}_{N_1}(F \cup x)}) + \varphi(V_{\text{cl}_{N_1}(F \cup y)}) - \varphi(V_{F_{p+1}}) = -1 - 1 - (-1) = -1.$$

□

Remark 3.3.17. One can use proposition 3.3.16 to obtain an inductive formula for the intersection product $B(N_1) \cdot_{B(M)} B(N_2)$ in the case that $B(N_2)$ is of a higher codimension (as long as all intermediate results are really rank functions).

Example 3.3.18. Let M be a matroid of rank r and let φ be the function which is linear on the cones of $B(M)$ and satisfies $\varphi(V_F) = r(F) - |F|$. Let $\mathcal{F} = (\emptyset \subsetneq F_1 \subsetneq \dots \subsetneq F_{r-2} \subsetneq$

E) be a chain of flats with $r(F_i) = i$ for $i \leq s$ and $r(F_i) = i + 1$ for $i > s$. Let S be the set of flats of M strictly containing F_s and strictly contained in F_{s+1} . Then we have

$$\begin{aligned} \omega_{\varphi \cdot \mathcal{B}(M)}(\langle \mathcal{F} \rangle) &= \sum_{F \in S} \varphi(V_F) - \varphi(V_{F_{s+1}}) - (|S| - 1) \cdot \varphi(V_{F_s}) \\ &= \sum_{F \in S} (s + 1 - |F|) - (s + 2) + |F_{s+1}| - (|S| - 1)(s - |F_s|) \\ &= |S| - 2. \end{aligned}$$

This means that the weight in $\varphi \cdot \mathcal{B}(M)$ of each cone $\tau \in \mathcal{B}(M)^{(r-1)}$ is the number of adjacent cones of τ minus 2. Note that cones which have only two adjacent facets are a result of a refinement (i.e. there is a coarser fan structure not containing the cone (cf. remarks 1.1.13 and 3.1.27)). Hence $\varphi \cdot \mathcal{B}(M)$ can be regarded as the codimension one skeleton of $\mathcal{B}(M)$. We should note that $\varphi \cdot \mathcal{B}(M)$ is the natural generalisation of the definition of the canonical divisor of tropical curves. Therefore, we denote $\varphi \cdot \mathcal{B}(M)$ by $K_{\mathcal{B}(M)}$ and show that it satisfies the following adjunction formula: If $\mathcal{B}(N)$ is a codimension 1 subcycle of $\mathcal{B}(M)$, then we have

$$K_{\mathcal{B}(N)} = (K_{\mathcal{B}(M)} + \mathcal{B}(N)) \cdot_{\mathcal{B}(M)} \mathcal{B}(N).$$

Let φ_1, φ_2 be functions which are linear on the cones of $\mathcal{B}(M)$ and satisfy $\varphi_1(V_F) = r_M(F) - |F|$, $\varphi_2(V_F) = r_N(F) - r_M(F)$ for all flats F of M . Then it follows by part (6) of theorem 3.3.7 that

$$(K_{\mathcal{B}(M)} + \mathcal{B}(N)) \cdot_{\mathcal{B}(M)} \mathcal{B}(N) = (\varphi_1 + \varphi_2) \cdot \mathcal{B}(N) = K_{\mathcal{B}(N)}.$$

Example 3.3.19. Let us consider again the Fano matroid F_7 of example 3.1.8. Example 3.3.18 implies that the coarse and the fine fan structure of $\mathcal{B}(F_7)$ are equal.

3.4. Dividing out the lineality space

So far, we have defined an intersection product on matroid fans $\mathcal{B}(M)$ which contain the lineality space $L = \mathbb{R} \cdot (1, \dots, 1)$. But in most applications, one is really interested in $\mathcal{B}(M)$ modulo its lineality space L . Therefore, we will now discuss how to derive an intersection product on $\mathcal{B}(M)/L$ from the known intersection product on $\mathcal{B}(M)$. First, let us fix some terminology.

Let \mathcal{X} be a polyhedral complex in a vector space V . The intersection $L := \bigcap_{\tau \in \mathcal{X}} V_\tau$ is called the lineality space of \mathcal{X} . If \mathcal{X} is a fan, L is just the unique inclusion-minimal cone of \mathcal{X} . We define the polyhedral complex \mathcal{X}/L in V/L by $\mathcal{X}/L := \{q(\tau) | \tau \in \mathcal{X}\}$, where $q : V \rightarrow V/L$ is the quotient map. If \mathcal{X} is weighted, $q(\sigma)$ inherits the weight from σ .

Let X be a tropical cycle in V . A subspace $L \subseteq V$ is called a lineality space of X if there is a polyhedral structure \mathcal{X} of X whose lineality space is L . In this case, we denote by X/L the tropical cycle in V/L associated to \mathcal{X}/L .

Let C be a cycle in X/L and let \mathcal{C} be a polyhedral structure of C . We define the polyhedral complex $q^{-1}(\mathcal{C})$ to be the collection of cells $\{q^{-1}(\sigma) | \sigma \in \mathcal{C}\}$ (with weights inherited from \mathcal{C}). Furthermore, we define $q^{-1}(C)$ to be the tropical cycle associated to $q^{-1}(\mathcal{C})$. By definition, L is a lineality space of $q^{-1}(C)$.

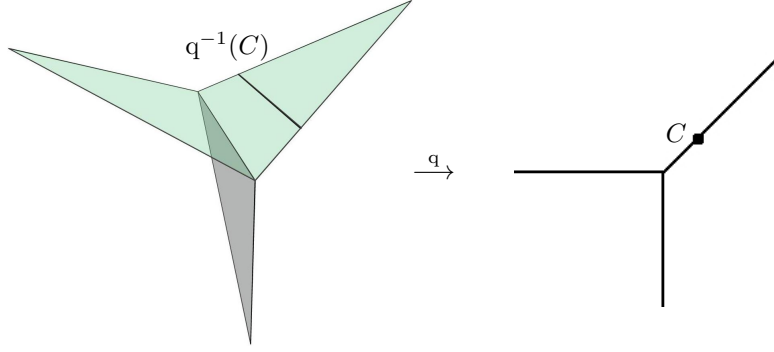

Cycle C in $B(U_{2,3})/L$ and $q^{-1}(C)$ in $B(U_{2,3})$.

Remark 3.4.1. It is easy to see that the cycles $(X/L) \times L$ and X are isomorphic if L is a lineality space of X : We choose an integer linear map $s : V/L \rightarrow V$ such that $q \circ s = \text{id}_{V/L}$. Then $X \rightarrow X/L \times L$, $x \mapsto (q(x), x - s(q(x)))$ is an isomorphism with inverse $(x, l) \rightarrow s(x) + l$.

Remark 3.4.2. Note that $X/L = \text{Star}_X(L)$ for any variety X with lineality space L . Therefore, it follows by proposition 1.2.9 that $(\varphi \cdot X)/L = \varphi^L \cdot X/L$ for any rational function φ that is affine linear on a polyhedral structure with lineality space L . For $L = \mathbb{R} \cdot (1, \dots, 1)$, this means that corollary 3.2.15 can be extended to the situation that $B(N)/L \subseteq B(M)/L$; i.e. there are rational functions $\varphi_1, \dots, \varphi_r$ on $B(M)/L$ (with $r := r(M) - r(N)$) such that

$$B(N)/L = \varphi_1 \cdots \varphi_r \cdot B(M)/L$$

and the intermediate intersection products $\varphi_k \cdots \varphi_r \cdot B(M)/L$ are still matroid varieties modulo L .

Example 3.4.3. Let \mathcal{X} be a polyhedral structure of a cycle X . For $\tau \in \mathcal{X}$ we have

$$\text{Star}_X(\tau) = \text{Star}_X(p)/V_\tau,$$

where p is a point in the relative interior of τ . Moreover, if L is the lineality space of \mathcal{X} , q is the associated quotient map and σ is a cell of \mathcal{X}/L , then

$$\text{Star}_{X/L}(\sigma) = \text{Star}_X(q^{-1}(\sigma)).$$

For $X = B(M)$, it follows by lemma 3.1.21 that

$$\text{Star}_{B(M)/L}(\sigma) = B(M_p)/V_{q^{-1}(\sigma)},$$

where p is a point in the relative interior of $q^{-1}(\sigma)$.

Tropicalisations of linear spaces constitute an important class of matroid varieties modulo their natural lineality space:

Example 3.4.4. Let $I \subsetneq \mathbb{C}[x_1, \dots, x_n]$ be an ideal that is generated by linear forms. The support of a linear form $l = a_1x_1 + \dots + a_nx_n + a_{n+1}$ is defined to be $\text{supp}(l) := \{i : a_i \neq 0\}$. The inclusion-minimal sets in $\{\text{supp}(l) : l \in I\}$ are called the circuits of I . They satisfy the circuit axioms of a matroid; so one can consider the matroid M on the ground set $\{1, \dots, n+1\}$ whose circuits are the circuits of I . It turns out that $\text{Trop}(V(I))$ is isomorphic to $B(M)/L$, with $L = \mathbb{R} \cdot (1, \dots, 1)$ (see [MS, section 5.2] or [Stu02, section 9.3]). That means that tropicalisations of linear spaces are matroid varieties modulo lineality spaces. Furthermore, it was shown in [KP11, corollary 1.5] that a matroid variety (modulo its natural lineality space) is a tropicalisation of a classical linear space if and only if the corresponding matroid is realisable over the corresponding field (cf. example 3.1.6). A fast algorithm for the computation of tropicalisations of linear spaces has been presented in [Rin]; it uses a fan structure of the tropicalisation which is slightly finer than the coarse subdivision (and much coarser than the fine subdivision).

The only thing we still need in order to define an intersection product on $B(M)/L$ is the following lemma:

Lemma 3.4.5. *Let C, D be two cycles in a matroid variety $B(M)$ and let us assume that L is a lineality space of each. Then L is also a lineality space of $C \cdot D$.*

PROOF. For all vectors $v \in L$ we can define the translation automorphism $\alpha_v : B(M) \rightarrow B(M)$ which sends x to $x + v$. For a subcycle of $B(M)$, having L as lineality space is equivalent to being invariant under all translations $\alpha_v, v \in L$. Now we use lemma 3.3.9 to see that this property is passed from C and D to $C \cdot D$ as

$$(\alpha_v)_*(C \cdot D) = (\alpha_v)_*C \cdot (\alpha_v)_*D = C \cdot D.$$

□

Definition 3.4.6. Let $B(M)$ be a matroid variety with lineality space L , and let C, D be two tropical cycles in $B(M)/L$. We define the intersection product $C \cdot D$ of C and D in $B(M)/L$ by

$$C \cdot D := (q^{-1}(C) \cdot q^{-1}(D))/L,$$

where on the right-hand side we use the previously defined intersection product on $B(M)$ (cf. definition 3.3.3). In words, we first take preimages of C and D in $B(M)$ and intersect them. By lemma 3.4.5, the result has lineality space L which we divide out again.

Remark 3.4.7. This definition also works for cartesian products $B(M)/L \times B(M')/L'$ as they are equal to $B(M \oplus M')/L \times L'$.

We are ready to state the main properties of the intersection product of cycles on matroid varieties modulo lineality space.

Corollary 3.4.8. *For all subcycles C, D, E of $B(M)/L$, the following properties hold:*

- (1) $|C \cdot D| \subseteq |C| \cap |D|$.
- (2) *If C and D are fan cycles, then $C \cdot D$ is a fan cycle, too.*
- (3) $(h \cdot C) \cdot D = h \cdot (C \cdot D)$ for any cocycle h on C .
- (4) $C \cdot B(M)/L = C$.
- (5) $C \cdot D = D \cdot C$.
- (6) *If $C = h \cdot B(M)/L$ for some cocycle h , then $C \cdot D = h \cdot D$.*
- (7) $(C \cdot D) \cdot E = C \cdot (D \cdot E)$.
- (8) $(C + D) \cdot E = C \cdot E + D \cdot E$.
- (9) *If \mathcal{C}, \mathcal{D} are polyhedral structures of the tropical cycles C, D and τ is a cell in $(\mathcal{C} \cap \mathcal{D})^{\leq (\dim(B(M)/L) - \text{codim}(C) - \text{codim}(D))}$, then*

$$\text{Star}_{C \cdot D}(\tau) = \text{Star}_C(\tau) \cdot \text{Star}_D(\tau),$$

where the intersection product on the left-hand side is computed in $B(M)/L$, whereas the one on the right-hand side is in $\text{Star}_{B(M)/L}(\tau)$ (cf. example 3.4.3).

- (10) $(A_1 \times A_2) \cdot (B_1 \times B_2) = (A_1 \cdot B_1) \times (A_2 \cdot B_2)$ if A_1, B_1 and A_2, B_2 are subcycles of $B(M_1)/L_1$ and $B(M_2)/L_2$ respectively.

PROOF. Properties (1)-(8) follow straight from the respective property in theorem 3.3.7. (9) follows from lemma 3.3.11, example 3.4.3 and the fact that $\text{Star}_{q^{-1}C}(p) = q^{-1} \text{Star}_C(q(p))$, where $q : V \rightarrow V/L$ is the quotient map and p is a point in $q^{-1}C$. (10) is direct consequence of lemma 3.3.10. □

Our next aim is to show that the intersection product of cycles on a matroid variety modulo lineality space can also be expressed as a push-forward along a projection of the intersection of the diagonal with the cross product of the cycles we want to intersect.

Proposition 3.4.9. *Let C, D be cycles in $B(M)/L$. Then $\Delta_{B(M)/L} \cdot (C \times D) = \Delta_{C \cdot D}$. In particular, we have*

$$C \cdot D = \pi_*(\Delta_{B(M)/L} \cdot C \times D),$$

where $\pi : B(M)/L \times B(M)/L \rightarrow B(M)/L$ is the projection to the first factor. Note that this is how we defined our intersection product on matroid varieties (cf. remark 3.3.8).

To prove this we use the following lemmas:

Lemma 3.4.10. *Let X be a tropical cycle with polyhedral structure \mathcal{X} whose lineality space is L . Let φ be a function which is affine linear on the cells of \mathcal{X} and let C be a cycle in X (not necessarily with lineality space L). Then the equation*

$$\varphi \cdot q^{-1} q_*(C) = q^{-1} q_*(\varphi \cdot C)$$

holds, where $q : X \rightarrow X/L$ is the quotient map.

PROOF. We first note that by adding a globally affine linear function to φ , we can assume that $\varphi = q^* \tilde{\varphi}$ for a suitable function $\tilde{\varphi}$ on X/L . In this case, it is obvious from the definitions and projection formula that both sides are equal to $q^{-1}(\tilde{\varphi} \cdot q_*(C))$. \square

Lemma 3.4.11. *Let L be a lineality space of a matroid variety $B(M)$ and $q : B(M) \rightarrow B(M)/L$ the corresponding quotient map. Let C, D be cycles in $B(M)$ such that L is a lineality space of D . Then $(q^{-1} q_* C) \cdot D = q^{-1} q_*(C \cdot D)$.*

PROOF. First, we split M into its connected components $M = \bigoplus_i M_i$ and pull back the functions of corollary 3.3.2 that cut out the diagonal of $B(M_i) \times B(M_i)$ to $B(M) \times B(M)$. With the help of lemma 3.1.28 this gives us functions on $B(M) \times B(M)$ which cut out the diagonal and are linear on the cones of a fan structure of $B(M) \times B(M)$ with lineality space Δ_L .

Now we set $j : B(M) \times B(M) \rightarrow (B(M) \times B(M))/\Delta_L$ to be the quotient map. Then we have $(q^{-1} q_* C) \times D = j^{-1} j_*(C \times D)$. Thus we are in the situation of the previous lemma, and intersecting with the diagonal gives $j^{-1} j_*(\Delta_{B(M)} \cdot C \times D)$. After projecting, this is $q^{-1} q_*(C \cdot D)$, which finishes our proof. \square

PROOF OF PROPOSITION 3.4.9. Let $q : B(M) \rightarrow B(M)/L$ be the quotient map. For any cycle A having lineality space L the following equality holds:

$$(q \times q)^{-1} \Delta_{A/L} = (\text{id} \times q)^{-1} (\text{id} \times q)_* \Delta_A. \quad (3.4)$$

The set-theoretic equality is clear; the equality of the cycles follows from the fact that all involved weights are inherited by the weights of A . By definition of our intersection products and equation (3.4) we have

$$\begin{aligned} \Delta_{B(M)/L} \cdot (C \times D) &= ((q \times q)^{-1} \Delta_{B(M)/L} \cdot q^{-1} C \times q^{-1} D)/L \times L \\ &= (((\text{id} \times q)^{-1} (\text{id} \times q)_* \Delta_{B(M)}) \cdot q^{-1} C \times q^{-1} D)/L \times L, \end{aligned}$$

as well as

$$\begin{aligned} \Delta_{C \cdot D} &= ((q \times q)^{-1} (\Delta_{(q^{-1} C \cdot q^{-1} D)/L}))/L \times L \\ &= ((\text{id} \times q)^{-1} (\text{id} \times q)_* (\Delta_{(q^{-1} C \cdot q^{-1} D)}))/L \times L \\ &= ((\text{id} \times q)^{-1} (\text{id} \times q)_* (\Delta_{B(M)} \cdot q^{-1} C \times q^{-1} D))/L \times L. \end{aligned}$$

Now the claim follows from lemma 3.4.11. \square

Remark 3.4.12. Let $B(M)/L$ be a quotient of a matroid variety and assume we can cut out the diagonal $\Delta_{B(M)/L}$ in $B(M)/L \times B(M)/L$ with a cocycle h . Then the intersection product defined by h , that is

$$C \cdot D := \pi_*(h \cdot C \times D),$$

agrees with the one defined in 3.4.6. This follows from proposition 3.4.9 together with property (6) of theorem 3.3.7.

Remark 3.4.13. Lemma 3.3.9 can be generalised to matroid varieties modulo lineality spaces, i.e. we have

$$\alpha_*(C \cdot D) = \alpha_* C \cdot \alpha_* D$$

for any isomorphism $\alpha : B(M)/L \rightarrow B(M')/L'$. We first use remark 3.4.7 and write $B(M)/L = (B(M) \times L')/(L \times L')$ resp. $B(M')/L' = (L \times B(M'))/(L \times L')$. In other words, we can assume that $B(M)$ and $B(M')$ lie in the same ambient vector space and that $L = L'$. In this situation we can lift α to an isomorphism $\tilde{\alpha} : B(M) \rightarrow B(M')$ with $q \circ \tilde{\alpha} = \alpha \circ q$ and use lemma 3.3.9.

We finish the section by giving a few examples.

Example 3.4.14. Let $M = U_{k+1, n+1}$ and $L := \mathbb{R} \cdot (1, \dots, 1)$. Then $B(M)/L$ is isomorphic to L_k^n (cf. example 3.1.18). Thus we have reproved the result of [All12] that the cycles L_k^n admit an intersection product of cycles. It follows from remark 3.4.12 that both intersection products agree.

Remark 3.4.15. Any matroid variety modulo its natural lineality space $L = \mathbb{R} \cdot (1, \dots, 1)$ is a cycle of degree 1 as by definition 1.3.9 and lemma 3.1.24

$$\begin{aligned} \deg B(M)/L &= \deg(B(M)/L \cdot U_{|E|-r(M)+1, |E|}/L) \\ &= \deg[(B(M) \cdot U_{|E|-r(M)+1, |E|})/L] \\ &= \deg[(\max\{x_1, \dots, x_{|E|}\}^{r(M)-1} \cdot B(M))/L] \\ &= \deg(L/L) \\ &= 1. \end{aligned}$$

This is not surprising as it is just the projectivised version of lemma 3.1.26. The converse statement – that degree 1 fan cycles in \mathbb{R}^n/L are matroid varieties modulo L – has been proved in [Fin, theorem 6.5].

Example 3.4.16. In order to compute the self-intersection of the rigid line $C := \mathbb{R} \cdot \begin{pmatrix} 1 \\ 1 \\ 0 \end{pmatrix}$ in L_2^3 we have to intersect the preimage of C in $B(U_{3,4})$ with itself. This was done in example 3.3.5. Now we only need to divide out the lineality space and see that $C \cdot_{L_2^3} C = (-1) \cdot \{0\}$ which agrees with the result obtained in [AR10, example 3.10].

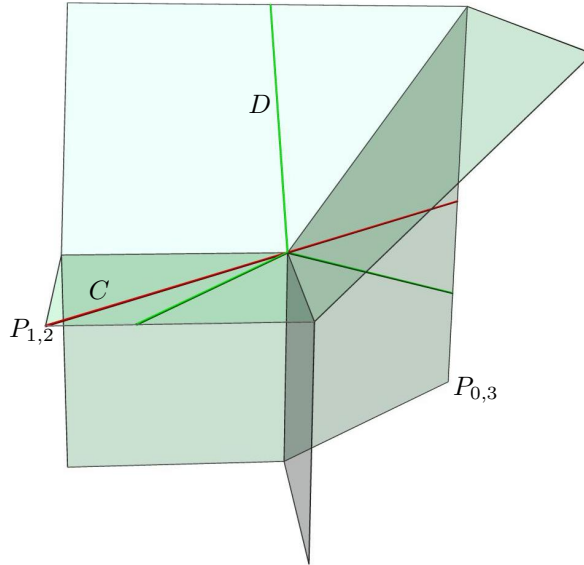

Example 3.4.17. Let D be the curve that has only trivial weights and consists of rays generated by $\begin{pmatrix} -2 \\ -3 \\ 0 \end{pmatrix}$, $\begin{pmatrix} 2 \\ 2 \\ -1 \end{pmatrix}$, $\begin{pmatrix} 0 \\ 1 \\ 1 \end{pmatrix}$ and let C be the line $\mathbb{R} \cdot \begin{pmatrix} 1 \\ 1 \\ 0 \end{pmatrix}$. We want to use part (6) of corollary 3.4.8 to compute the intersection product $C \cdot D$ in L_2^3 . Therefore, let \mathcal{X} be the minimal fan structure of L_2^3 that contains the edges of C . We observe that the rational function φ that is linear on the cones of \mathcal{X} and maps

$$\begin{pmatrix} 0 \\ -1 \\ 0 \end{pmatrix} \mapsto 0, \quad \begin{pmatrix} 1 \\ 1 \\ 1 \end{pmatrix}, \begin{pmatrix} 0 \\ 0 \\ -1 \end{pmatrix}, \begin{pmatrix} 1 \\ 1 \\ 0 \end{pmatrix} \mapsto 1, \quad \begin{pmatrix} -1 \\ -1 \\ 0 \end{pmatrix} \mapsto -2, \quad \begin{pmatrix} -1 \\ 0 \\ 0 \end{pmatrix} \mapsto -1$$

satisfies $\varphi \cdot L_2^3 = C$. Hence we can conclude that

$$C \cdot D = \varphi \cdot C = \left(\varphi \begin{pmatrix} -2 \\ -3 \\ 0 \end{pmatrix} + \varphi \begin{pmatrix} 2 \\ 2 \\ -1 \end{pmatrix} + \varphi \begin{pmatrix} 0 \\ 1 \\ 1 \end{pmatrix} \right) \cdot \{0\} = (-4 + 3 + 0) \cdot \{0\} = (-1) \cdot \{0\}.$$

Remark 3.4.18. We have seen in examples 3.3.13, 3.3.14 3.4.16 and 3.4.17 that intersection products of tropical varieties on matroid varieties (modulo lineality spaces) can have negative weights, even if they intersect in the right dimension (as observed in 3.4.17). This presents a stark contrast to both, the classical case and the case of intersection products in vector spaces (cf. remark 1.3.5). There are a couple of technical and intuitive explanations for this phenomenon:

- Contrary to case of vector spaces, the rational functions of corollary 3.3.2 that cut out the diagonal are not convex for general matroids. Therefore, proposition 1.2.11 does not prevent intersection products from having negative weights.
- The strategy of remark 1.3.13 to slightly move subvarieties or to replace them by rational equivalent cycles such that they intersect properly (i.e. in the right dimension and in the interior of a maximal cell) does not work in general as translations might cause subvarieties to leave the ambient variety. This is clearly the case for the rigid line of example 3.4.16.
- Our ambient spaces are not compact, so intersection products might have hidden components in the boundary. If these boundary components are too big, then they may need to be compensated by negative weights in the interior. One can prove that, defining suitable intersection multiplicities at infinite points, Bézout's theorem holds for curves on suitable compactifications of matroid varieties modulo lineality spaces. We refer to [Fra09, definition 3.8, theorem 3.13] for a very detailed discussion of the case of L_2^3 and to [BS, definitions 3.1 and 3.5] for the general case. The (compactifications of the) curves C and D of example 3.4.17 intersect with multiplicity $\min\{2 \cdot 1, 3 \cdot 1\} = 2$ in the boundary point $P_{1,2}$ (see above figure) and with multiplicity $\min\{2 \cdot 1, 3 \cdot 1\} = 2$ in $P_{0,3}$. Therefore, Bézout's theorem forces the intersection multiplicity of the origin to be $\deg(D) \cdot \deg(C) - 2 - 2 = -1$.
- Negative intersection products can also answer relative realisability questions, i.e. whether the involved curves are tropicalisations of classical curves contained in a classical linear space that tropicalises to the given tropical ambient space. This is the topic of [BS] and will be further discussed in remark 3.7.10.

It is sometimes interesting to consider codimension 1 skeletons of cycles in tropical geometry; for example, the codimension 1 skeleton of the moduli space of n -marked abstract rational curves \mathcal{M}_n consists of abstract curves which have at least one 4-valent vertex. We saw in example 3.3.18 that matroid fans come with a natural choice of weight function to give the codimension 1 skeleton the structure of a tropical cycle. The following example answers the question of irreducibility of codimension 1 skeletons of tropical planes.

Example 3.4.19. Let M be a matroid of rank 3 and let $X = B(M)/L$ be the corresponding matroid variety modulo $L = \mathbb{R} \cdot (1, \dots, 1)$. If X is (isomorphic to) L_2^n , $L_1^n \times \mathbb{R}$ or \mathbb{R}^2 , then

its codimension 1 skeleton is L_1^n , $\{0\} \times \mathbb{R}$ or \emptyset respectively, and thus irreducible. We want to show that in all other cases the skeleton of X is reducible. By pooling parallel elements (that is elements i, j with $r(\{i, j\}) = 1$) we can assume that each singleton is a flat of M . Let $E(M) = \{1, \dots, n\}$. Let us first assume that every flat of rank 1 is contained in at least 3 flats of rank 2. As $M \neq U_{3,n}$ we know that there is at least one flat F of rank 2 that contains at least 3 elements. Remembering that the weight of a cone of the skeleton is the number of adjacent cones minus 2, we can conclude that the skeleton of X has at least $n + 1$ rays (corresponding to the n flats of rank 1 and F). Since X is contained in \mathbb{R}^n/L this implies that its codimension 1 skeleton must be reducible.

Now let us assume that the flat $\{1\}$ is only contained in two flats of rank 2, say $\{1, \dots, k\}$ and $\{1, k + 1, k + 2, \dots, n\}$, with $2 \leq k \leq n - 1$. The axioms on the flats of M imply that the remaining flats of rank 2 are exactly $\{i, j\}$, with $2 \leq i \leq k < j \leq n$. So the skeleton of X has rays corresponding to the flats $\{2\}, \dots, \{k\}, \{1, k + 1, \dots, n\}$ of weight $n - k - 1$ and $\{k + 1\}, \dots, \{n\}, \{1, \dots, k\}$ of weight $k - 2$. This is a reducible curve unless $k \in \{2, n - 1\}$ in which case X is isomorphic to $L_1^{n-2} \times \mathbb{R}$.

3.5. Intersection product on smooth varieties

In this section we construct an intersection product of cycles on smooth (abstract) tropical varieties by using the intersection product of the previous section locally.

Definition 3.5.1. An abstract tropical cycle X is called smooth variety if it looks locally like a matroid variety modulo lineality space, i.e. if all X_i of definition 2.2.4 are matroid varieties modulo lineality spaces.

Remark 3.5.2. We note that a cycle X in a vector space is smooth if and only if the star $\text{Star}_X(p)$ around each point p of X is isomorphic to a matroid variety modulo lineality space (cf. remark 2.2.9).

Remark 3.5.3. Let X be a smooth variety in a vector space. As the local building blocks of X are locally irreducible we can conclude that X is also locally irreducible. If X is connected, its smoothness implies that it is also connected in codimension 1. Therefore, it follows from proposition 1.1.26 that connected smooth varieties are irreducible.

We are ready to define an intersection product $C \cdot D$ of cycles C, D on a smooth variety X . The idea is to intersect the local cycles C_i, D_i on X_i and then glue the resulting local intersection products together to obtain a cycle in X .

Definition and Construction 3.5.4. Let C, D be tropical cycles (of codimension r, s) in a smooth (abstract) d -dimensional variety X . Let C_i, D_i be cycles in V^{W_i} such that

$$\phi_i(C \cap U_i) = C_i \cap W_i, \quad \phi_i(D \cap U_i) = D_i \cap W_i$$

(cf. definition 2.2.6). The fact that X_i is a matroid variety modulo lineality space allows us to define the local intersection product $(C_i \cap W_i) \cdot (D_i \cap W_i)$ to be the open cycle that satisfies for all points p in $|C_i| \cap |D_i| \cap W_i$ the equation

$$\text{Star}_{(C_i \cap W_i) \cdot (D_i \cap W_i)}(p) = \text{Star}_{C_i}(p) \cdot \text{Star}_{D_i}(p),$$

where right-hand side intersection product is computed in the matroid variety modulo lineality space $\text{Star}_{X_i}(p)$. Note that this does not depend on the choice of local cycles C_i, D_i . If $p \in U_i \cap U_k$, then the map $\phi_k \circ \phi_i^{-1}$ induces an isomorphism $\text{Star}_{X_i}(\phi_i(p)) \rightarrow \text{Star}_{X_k}(\phi_k(p))$ which maps the stars of C_i, D_i around $\phi_i(p)$ to the stars of C_k, D_k around $\phi_k(p)$; it follows that the local intersection products agree on the overlap $U_i \cap U_k$ (cf. remark 3.4.13). Therefore, we can glue the local intersection products together to obtain the global intersection product $C \cdot D \in Z_{d-r-s}(X)$.

Remark 3.5.5. If C, D are two subcycles of a smooth variety X contained in a vector space V , then the intersection product $C \cdot D$ on X is just the unique subcycle of X satisfying

$$\text{Star}_{C \cdot D}(p) = \text{Star}_C(p) \cdot \text{Star}_D(p)$$

for every point $p \in X$. Note that the right-hand side is an intersection product of cycles in the matroid variety modulo lineality space $\text{Star}_X(p)$.

The following theorem is an immediate consequence of the local definition of our intersection product and corollary 3.4.8:

Theorem 3.5.6. *Let X be a smooth tropical variety and let C and D be subcycles of X . Then the following properties hold:*

- (1) $|C \cdot D| \subseteq |C| \cap |D|$.
- (2) $(h \cdot C) \cdot D = h \cdot (C \cdot D)$ for any cocycle h on C .
- (3) $C \cdot X = C$.
- (4) $C \cdot D = D \cdot C$.
- (5) If $C = h \cdot X$, then $C \cdot D = h \cdot D$.
- (6) $(C \cdot D) \cdot E = C \cdot (D \cdot E)$.
- (7) $(C + D) \cdot E = C \cdot E + D \cdot E$.
- (8) $(A_1 \times A_2) \cdot (B_1 \times B_2) = (A_1 \cdot B_1) \times (A_2 \cdot B_2)$ if A_1, B_1 and A_2, B_2 are subcycles of the two smooth varieties X_1 and X_2 respectively.

Remark 3.5.7. Let $f : X \rightarrow Y$ be an isomorphism of smooth varieties and let C, D be subcycles of X . It is easy to see that we can extend remark 3.4.13 to this case (cf. definition 2.2.10); that means

$$f_*(C \cdot D) = f_*C \cdot f_*D.$$

Moreover, we can extend proposition 3.4.9 and check locally that we have

$$C \cdot D = \pi_*(\Delta_X \cdot C \times D).$$

Remark 3.5.8. Let X be a smooth tropical variety. By gluing together the canonical divisors K_{X_i} of the local blocks X_i of X (cf. example 3.3.18) we obtain a cycle $K_X \in Z_{\dim X - 1}(X)$. Let C be a codimension 1 subcycle of X such that for all $p \in C$ and i such that $p \in U_i$

$$\text{Star}_{C_i}(\phi_i(p)) = \text{B}(N^p)/L^p \subsetneq \text{B}(M^p)/L^p = \text{Star}_{X_i}(\phi_i(p))$$

for some matroids N^p, M^p and lineality spaces L^p . Note that this condition implies that C is smooth. Then it follows easily from the locality of the intersection product and example 3.3.18 that

$$K_C = (K_X + C) \cdot_X C.$$

3.6. Pull-back of cycles

In this section we construct a pull-back of cycles along morphisms of smooth varieties. A discussion of this construction for less general smooth varieties (in our terminology, in the case of only uniform matroids) can be found in [All12, section 3]. We show that modifications are a special case of our pull-back, which will be used to prove that our intersection product agrees with the intersection product introduced in [Sha] in the next section.

Definition 3.6.1. Let $f : X \rightarrow Y$ be a morphism of smooth tropical varieties. We define the pull-back of a cycle C in Y to be

$$f^*C := \pi_*(\Gamma_f \cdot (X \times C)),$$

where $\pi : X \times Y \rightarrow X$ is the projection to the first factor and Γ_f is the graph of f , which means that $\Gamma_f := \gamma_{f_*}(X)$, with $\gamma_f : X \rightarrow X \times Y$, $x \mapsto (x, f(x))$.

Note that here $\Gamma_f \cdot (X \times C)$ is an intersection product of cycles in $X \times Y$, which is smooth by our assumptions. We observe that the codimension of C in Y equals the codimension of f^*C in X and that by theorem 3.5.6 we have $|f^*C| \subseteq f^{-1}|C|$. Moreover, we obviously have $f^*(C + C') = f^*C + f^*C'$.

Example 3.6.2. Let us give some examples.

- (1) Let $f : X \rightarrow Y$ be a morphism of smooth tropical varieties. Then $f^*Y = X$. This follows easily from $\pi_*\Gamma_f = X$.
- (2) If $C = h \cdot Y$ is a subcycle of Y cut out by a cocycle, then we have

$$f^*C = f^*h \cdot X.$$

If we denote the two projections of $X \times Y$ by π_X and π_Y , then by definition the function π_Y^*h agrees on Γ_f with the function $\pi_X^*f^*h$ and the above equation follows from the projection formula.

- (3) Let $\text{id} : X \rightarrow X$ be the identity morphism. Then $\Gamma_{\text{id}} = \Delta_X$, and we conclude $\text{id}^*C = X \cdot C = C$ for all subcycles C of X .
- (4) Let $p : X \times Y \rightarrow Y$ be the projection to Y . Then $\Gamma_p = X \times \Delta_Y$, and it follows easily that $p^*C = X \times C$ for all subcycles C of Y .
- (5) For $i \in \{1, 2\}$, let $f_i : X_i \rightarrow Y_i$ be a morphism of smooth varieties and let C_i be a cycle in Y_i . Then it follows by theorem 3.5.6(8) and proposition 1.1.31(3) that

$$f_1^*C_1 \times f_2^*C_2 = (f_1 \times f_2)^*(C_1 \times C_2).$$

Our next goal is to prove the following properties of pull-backs:

Theorem 3.6.3. *Let X, Y and Z be smooth tropical varieties and let $f : X \rightarrow Y$ and $g : Y \rightarrow Z$ be two morphisms. Let C, C' be two cycles in Y , D a cycle in X and E a cycle in Z . Then the following holds:*

- (1) $C \cdot f_*D = f_*(f^*C \cdot D)$
- (2) $f^*(C \cdot C') = f^*C \cdot f^*C'$
- (3) $(g \circ f)^*E = f^*g^*E$

Remark 3.6.4. The projection formula for cycles of the preceding theorem is a natural generalisation of the projection formula for cocycles (cf. proposition 2.3.9) in the case where f is a morphism of smooth varieties.

In a first step we prove the theorem for matroid varieties X, Y, Z . We need the following lemma:

Lemma 3.6.5. *Let $f : X \rightarrow Y$ be a morphism between matroid varieties. Then we have*

$$(\{x\} \times Y) \cdot \Gamma_f = \{(x, f(x))\} \tag{3.5}$$

for each point x of X .

Let $g : Y \rightarrow Z$ be another morphism of matroid varieties and set $\Phi : X \rightarrow X \times Y \times Z$, $x \mapsto (x, f(x), g(f(x)))$. Then we have

$$\Phi_*X = (\Gamma_f \times Z) \cdot (X \times \Gamma_g). \tag{3.6}$$

Analogously, if $a : X \rightarrow Z$ is a third morphism of matroid varieties and we set $\Phi : X \rightarrow X \times Y \times Z$, $x \mapsto (x, f(x), a(x))$, then we have

$$\Phi_*X = (\Gamma_f \times Z) \cdot (\Gamma_a \times Y). \tag{3.7}$$

Note that, by abuse of notation with regard to the order of the factors, $(\Gamma_a \times Y)$ lives in $X \times Y \times Z$.

PROOF. We start with equation (3.5). It is obvious that the support of the left-hand side is either the point $(x, f(x))$ or the empty set, so it suffices to check that the degree of the left-hand side is 1. Taking the star around the point $(x, f(x))$, we can assume that x is the origin. As x is cut out by rational functions on X (which is an easy consequence of lemma 3.1.24), $\{x\} \times Y$ is cut out by the pull-backs of these functions and the projection formula proves the claim.

For the equation (3.6), we start by noting that

$$|(\Gamma_f \times Z) \cdot (X \times \Gamma_g)| \subseteq |(\Gamma_f \times Z)| \cap |(X \times \Gamma_g)| = |\Phi_* X|.$$

As $\Phi_* X$ is irreducible and both cycles have the same dimension, we can conclude that both sides can only differ by a global factor. We can see that this factor is indeed 1 by intersecting both sides with $\{x\} \times Y \times Z$, where $x \in |X|$ is any point. Equation (3.5) then implies that we get $1 \cdot \{(x, f(x), g(f(x)))\}$ on both sides.

Equation (3.7) can be proven completely analogously. \square

PROOF OF THEOREM 3.6.3 FOR MATROID VARIETIES X, Y, Z . We give rather short proofs of the three properties if X, Y, Z are matroid varieties. We skip the details of a couple of straightforward computations because they are completely analogous to the computations in [All12, theorem 3.3]. In what follows, $\pi := \pi_X$ denotes the projection of a product of X, Y and Z to the factor X .

To prove (1), it essentially suffices to show $(f \times \text{id})^* \Delta_Y = \Gamma_f$, where $f \times \text{id} : X \times Y \rightarrow Y \times Y$. Using this, a straightforward computation, which relies heavily on the projection formula for piecewise polynomials (cf. proposition 2.1.21(5)) and (thus) on the ability to express the diagonal of a matroid variety as a piecewise polynomial, shows that

$$C \cdot f_* D = f_* \pi_* (\Gamma_f \cdot D \times C) = f_* (f^* C \cdot D).$$

The equation $(f \times \text{id})^* \Delta_Y = \Gamma_f$ is clear set-theoretically and, as Γ_f is irreducible, the equality of weights can be checked using the first equation of lemma 3.6.5 and part (2) of example 3.6.2.

To prove (2), we use (1) to show that

$$f^*(C \cdot C') = \pi_* ((\Gamma_f \times Y) \cdot (X \times \Gamma_{\text{id}_Y}) \cdot (X \times C \times C'))$$

and the equality $(f^* C) \cdot D = \pi_* (\Gamma_f \cdot D \times C)$ to see that

$$f^* C \cdot f^* C' = \pi_* (\pi_{1,2}^* \Gamma_f \cdot \pi_{1,3}^* \Gamma_f \cdot (X \times C \times C')),$$

with $\pi_{1,i} : X \times Y \times Y \rightarrow X \times Y, (x, y_1, y_2) \mapsto (x, y_i)$. Using both the second and third equality of lemma 3.6.5 (with $a = f$ and $g = \text{id}$) together with part (4) of example 3.6.2, we see that both terms coincide.

To prove (3), we compute that

$$(g \circ f)^* E = \pi_* (\Phi_* X \cdot (X \times Y \times E)),$$

where $\Phi : X \rightarrow X \times Y \times Z$ maps x to $(x, f(x), g(f(x)))$, and use (1) to see that

$$f^* g^* E = \pi_* ((\Gamma_f \times Z) \cdot (X \times \Gamma_g) \cdot (X \times Y \times E)).$$

Using the second equation of lemma 3.6.5 again, the claim follows. \square

Remark 3.6.6. Let us stress again that the previous proof relies heavily on the existence of a cocycle on $X \times X$ that cuts out the diagonal. Therefore, we can only prove the theorem for matroid varieties in this way.

In order to extend this proof to arbitrary smooth varieties we need another technical proposition:

Proposition 3.6.7. *Consider the following commutative diagram of tropical morphisms.*

$$\begin{array}{ccc} \mathbb{B}(M) & \xrightarrow{g} & \mathbb{B}(N) \\ \mathfrak{q} \downarrow & & \downarrow \mathfrak{j} \\ \mathbb{B}(M)/L & \xrightarrow{f} & \mathbb{B}(N)/K \end{array}$$

Here L, K are lineality spaces and $\mathfrak{q}, \mathfrak{j}$ are the respective quotient maps. Let C be a cycle in $\mathbb{B}(N)/K$. Then the following equality holds:

$$\mathfrak{q}^{-1} f^* C = g^* \mathfrak{j}^{-1} C,$$

or equivalently

$$f^* C = (g^* \mathfrak{j}^{-1} C)/L.$$

PROOF. Since the cycles Γ_f and Γ_g carry only trivial weights, the equality

$$|(\mathfrak{q} \times \mathfrak{j})^{-1} \Gamma_f| = \{(x, y) : x \in |\mathbb{B}(M)|, \mathfrak{j}(y) = f \circ \mathfrak{q}(x)\} = |(\text{id} \times \mathfrak{j})^{-1} (\text{id} \times \mathfrak{j})_* (\Gamma_g)|$$

implies the equality of cycles

$$(\mathfrak{q} \times \mathfrak{j})^{-1} \Gamma_f = (\text{id} \times \mathfrak{j})^{-1} (\text{id} \times \mathfrak{j})_* (\Gamma_g).$$

Let $\pi : \mathbb{B}(M)/L \times \mathbb{B}(N)/K \rightarrow \mathbb{B}(M)/L$ and $\tilde{\pi} : \mathbb{B}(M) \times \mathbb{B}(N) \rightarrow \mathbb{B}(M)$ be projections to the first factor. It follows from the above equality that

$$\begin{aligned} f^* C &= \pi_* (((\mathfrak{q} \times \mathfrak{j})^{-1} \Gamma_f \cdot (\mathbb{B}(M) \times \mathfrak{j}^{-1} C))/L \times K) \\ &= \pi_* (((\text{id} \times \mathfrak{j})^{-1} (\text{id} \times \mathfrak{j})_* (\Gamma_g) \cdot (\mathbb{B}(M) \times \mathfrak{j}^{-1} C))/L \times K). \end{aligned}$$

Applying lemma 3.4.11 to the quotient map $(\text{id} \times \mathfrak{j})$, we see that the above is equal to

$$\begin{aligned} &\pi_* (((\text{id} \times \mathfrak{j})^{-1} (\text{id} \times \mathfrak{j})_* (\Gamma_g \cdot (\mathbb{B}(M) \times \mathfrak{j}^{-1} C)))/L \times K) \\ &= \pi_* ((\text{id} \times \mathfrak{j})_* (\Gamma_g \cdot (\mathbb{B}(M) \times \mathfrak{j}^{-1} C))/L \times \{0\}) \\ &= (\tilde{\pi}_* (\Gamma_g \cdot (\mathbb{B}(M) \times \mathfrak{j}^{-1} C)))/L \\ &= (g^* \mathfrak{j}^{-1} C)/L. \end{aligned}$$

□

PROOF OF THEOREM 3.6.3 FOR SMOOTH VARIETIES X, Y, Z . We have already proved the claim for matroid varieties X, Y and Z . Therefore, let X, Y, Z be matroid varieties modulo lineality spaces. As in remark 3.4.13 we can assume that X, Y, Z live in the same ambient space \mathbb{R}^n/L , that is $X = \mathbb{B}(M)/L, Y = \mathbb{B}(N)/L$ and $Z = \mathbb{B}(K)/L$ for some matroids M, N, K . We lift the morphisms $f : \mathbb{B}(M)/L \rightarrow \mathbb{B}(N)/L$ and $g : \mathbb{B}(N)/L \rightarrow \mathbb{B}(K)/L$ to the morphisms $\hat{f} : \mathbb{B}(M) \rightarrow \mathbb{B}(N)$ and $\tilde{g} : \mathbb{B}(N) \rightarrow \mathbb{B}(K)$ induced by $f \times \text{id}_L$ and $g \times \text{id}_L$ (cf. remark 3.4.1). Now we use proposition 3.6.7 and the respective properties for \hat{f}, \tilde{g} to conclude that theorem 3.6.3 also holds for the morphisms f, g between matroid varieties modulo lineality spaces. Moreover, as all constructions are based on intersection products and are therefore defined locally, the statements hold for all smooth varieties. □

Remark 3.6.8. Let $\mathbb{B}(M)$ be a matroid variety with lineality space L and let $\mathfrak{q} : \mathbb{B}(M) \rightarrow \mathbb{B}(M)/L$ be the quotient map. Then the pull-back $\mathfrak{q}^*(C)$ coincides with $\mathfrak{q}^{-1}(C)$ as defined previously. This is a direct consequence of proposition 3.6.7.

Remark 3.6.9. Let $f : X \rightarrow Y$ be a morphism of smooth tropical varieties such that $f_* X = Y$. Then it follows from the first part of theorem 3.6.3 that $f_* f^* C = C$ holds for any cycle C in Y .

The following proposition relates the pull-back of a cycle along the restriction of a morphism to the pull-back of the cycle along the original morphism.

Proposition 3.6.10. *Let $f : X \rightarrow Y$ and its restriction $f|_{X'} : X' \rightarrow Y$ be morphisms of smooth tropical varieties. Then for every subcycle C of Y we have*

$$(f|_{X'})^*C = f^*C \cdot X',$$

where the right-hand side is an intersection product of cycles in X .

Our proof uses the following lemma whose proof is the same as the one given in [All10, example 3.3.4] for a less general setting.

Lemma 3.6.11. *Let X' be a smooth variety contained in the smooth variety X and let $i : X' \hookrightarrow X$ be the corresponding inclusion morphism. Then for every subcycle C of X we have*

$$i^*C = X' \cdot_X C.$$

PROOF. Let $\pi_X : X' \times X \rightarrow X$ and $\pi_{X'} : X' \times X \rightarrow X'$ be the projections to the respective factor. As the graph of i is equal to the diagonal $\Delta_{X'}$, we obtain by part (4) of example 3.6.2 and part (1) of theorem 3.6.3 that

$$i^*C = \pi_{X',*}(\Delta_{X'} \cdot X' \times C) = \pi_{X,*}(\Delta_{X'} \cdot \pi_X^*C) = X' \cdot C.$$

□

PROOF OF PROPOSITION 3.6.10. We factorise the restriction into $f|_{X'} = f \circ i$, where $i : X' \hookrightarrow X$ is the inclusion morphism. We know by part three of theorem 3.6.3 that $(f|_{X'})^*C = i^*f^*C$. Therefore, the claim follows from the previous lemma. □

Proposition 3.6.10 enables us to define pull-backs in a slightly more general setting.

Definition 3.6.12. Let X be a cycle in a vector space and let Y be a smooth variety. Let V_X be the smallest vector space containing X . Let $f : X \rightarrow Y$ be a morphism that can be extended to a morphism $\tilde{f} : V_X \rightarrow Y$. Then we define the pull-back of a cycle C in Y to be

$$f^*C := \tilde{f}^*C \cdot X,$$

where the intersection product is computed in V_X .

Remark 3.6.13. The pull-back of definition 3.6.12 is linear, preserves codimensions and satisfies $|f^*C| \subseteq f^{-1}|C|$. Furthermore, it satisfies the properties listed in example 3.6.2 and part (3) of theorem 3.6.3. Note that part (1) and (2) of theorem 3.6.3 are not well-defined if X is not smooth.

Example 3.6.14. Let $f : X \rightarrow V$ be a globally affine linear morphism from a tropical cycle in a vector space to a vector space. Then f can be extended to a morphism $V_X \rightarrow V$ and therefore each cycle C in V has a well-defined pull-back f^*C along f .

Remark 3.6.15. In definition 3.6.12 we required the morphism f to have an extension to the whole vector space V_X rather than to just have an extension to some smooth variety X' that contains X . We do so to avoid any choices in the definition of the pull-back that might result in a not well-defined pull-back. However, if, for whatever reason, there is a canonical smooth variety X' that contains X such that one can uniquely extend f to a morphism $\tilde{f} : X' \rightarrow Y$, one can define the pull-back of f^*C to be the intersection product $\tilde{f}^*C \cdot_{X'} X$. This pull-back still satisfies the properties listed in the previous remark.

Our next aim is to compare our tropical pull-back of cycles with the classical pull-back of Chow cohomology classes. Therefore, let $\Lambda^1 \rightarrow \Lambda^2$ be a homomorphism of lattices giving rise to a tropical morphism $f : V_1 \rightarrow V_2$. Let Δ_1, Δ_2 be fan structures of V_1, V_2 (i.e. complete fans) such that for all $\sigma_1 \in \Delta_1$ there is a cone σ_2 in Δ_2 such that $f(\sigma_1) \subseteq \sigma_2$. Then f induces a morphism $\bar{f} : X(\Delta_1) \rightarrow X(\Delta_2)$ of the corresponding complete toric varieties.

Let d_i be the dimension of V_i . Recall that the group of Minkowski weights $Z_{d_i-k}(\Delta_i)$ is isomorphic to the Chow cohomology group $A^k(X(\Delta_i))$. As [FS97, corollary 3.7] gives a combinatorial formula for the pull-back $\bar{f}^* : A^k(X(\Delta_2)) \rightarrow A^k(X(\Delta_1))$, showing that the tropical pull-back satisfies the same formula is all we need to prove the equivalence of the tropical and classical pull-back:

Proposition 3.6.16. *Let $\mathcal{C} \in Z_{d_2-k}(\Delta_2)$ be a Minkowski weight and let C be its associated fan cycle. Then $\Delta_1^{(\leq d_1-k)}$ together with the weights*

$$\omega(\gamma_1) := \sum_{\sigma_1 \in \Delta_1^{(d_1)} : \gamma_1 \leq \sigma_1} \sum_{\tau_2 \in \mathcal{C}^{(d_2-k)} : f(\gamma_1) \subseteq \tau_2} m_{\sigma_1, \tau_2}^{\gamma_1} \cdot \omega_{\mathcal{C}}(\tau_2),$$

where

$$m_{\sigma_1, \tau_2}^{\gamma_1} := \begin{cases} |\Lambda^2/f(\Lambda_{\sigma_1}^1) + \Lambda_{\tau_2}^2|, & \text{if } f(\sigma_1) \cap (\tau_2 + v_2) \neq \emptyset, \\ 0, & \text{else} \end{cases},$$

where v_2 is a generic vector in V_2 , is a fan structure of f^*C .

PROOF. Let $\pi_i : V_1 \times V_2 \rightarrow V_i$ be the projection to the respective factor. We use the fan displacement rule (remark 1.3.13) to compute the intersection product $\Gamma_f \cdot (V_1 \times C)$. We choose the fan structures $\Gamma_f^{\Delta_1} := \{(\text{id} \times f)(\sigma_1) : \sigma_1 \in \Delta_1\}$ of Γ_f ,

$$\Delta := (\Delta_1 \times \Delta_2) \cap \mathcal{H}_{f(x)_1-y_1} \cap \dots \cap \mathcal{H}_{f(x)_{d_2}-y_{d_2}}$$

of $V_1 \times V_2$ (cf. example 1.1.5) and

$$\mathcal{Y} := (\Delta_1 \times \mathcal{C}) \cap \mathcal{H}_{f(x)_1-y_1} \cap \dots \cap \mathcal{H}_{f(x)_{d_2}-y_{d_2}}$$

of $V_1 \times C$. Let $(v_1, v_2) \in V_1 \times V_2$ be generic. As the chosen fan structures $\Gamma_f^{\Delta_1}$ and \mathcal{Y} are Minkowski weights in Δ we can use remark 1.3.13 to conclude that our intersection product consists of cones $\tau \in \Delta^{(d_1-k)}$ such that $\tau \in \Gamma_f^{\Delta_1}$ and $\pi_2(\tau) \subseteq |C|$ of weight

$$\omega(\tau) = \sum_{\sigma_1, \alpha} |(\Lambda^1 \times \Lambda^2)/((\Lambda^1 \times \Lambda^2)_{(\text{id} \times f)(\sigma_1)} + (\Lambda^1 \times \Lambda^2)_{\alpha})| \cdot \omega_{\Gamma_f^{\Delta_1}}((\text{id} \times f)(\sigma_1)) \cdot \omega_{\mathcal{Y}}(\alpha),$$

where $\sigma_1 \in \Delta_1^{(d_1)}$ with $\pi_1(\tau) \leq \sigma_1$ and $\alpha \in \mathcal{Y}^{(d_1+d_2-k)}$ such that $\tau \leq \alpha$ and

$$(\text{id} \times f)(\sigma_1) \cap (\alpha + (v_1, v_2)) \neq \emptyset.$$

We notice that $\omega_{\Gamma_f^{\Delta_1}}((\text{id} \times f)(\sigma_1)) = \omega_{\Delta_1}(\sigma_1) = 1$. We denote the unique cone of \mathcal{C} that contains the cone $\pi_2(\alpha)$ by $\overline{\pi_2(\alpha)}$ and note that the weight of $\overline{\pi_2(\alpha)}$ in \mathcal{C} is equal to $\omega_{\mathcal{Y}}(\alpha)$. Next we observe that

$$\begin{aligned} (\Lambda^1 \times \Lambda^2)/((\Lambda^1 \times \Lambda^2)_{(\text{id} \times f)(\sigma_1)} + (\Lambda^1 \times \Lambda^2)_{\alpha}) &\rightarrow \Lambda^2/(f(\Lambda_{\sigma_1}^1) + \Lambda_{\pi_2(\alpha)}^2) \\ (x, y) &\mapsto y \end{aligned}$$

is an isomorphism of lattices. To be able to sum over cones in \mathcal{C} rather than over cones in \mathcal{Y} , we claim that for fixed σ_1, τ as above the assignment

$$\begin{aligned} \left\{ \begin{array}{l} \alpha \in \mathcal{Y}^{(d_1+d_2-k)} : \alpha \geq \tau, \\ (\text{id} \times f)(\sigma_1) \cap (\alpha + (v_1, v_2)) \neq \emptyset \end{array} \right\} &\rightarrow \left\{ \beta \in \mathcal{C}^{(d_2-k)} : f(\pi_1(\tau)) \subseteq \beta, f(\sigma_1) \cap (\beta + v_2) \neq \emptyset \right\} \\ \alpha &\mapsto \overline{\pi_2(\alpha)} \end{aligned}$$

is a bijection. In order to prove the surjectivity we pick a cone β in the right-hand side set and a point $x \in \sigma_1$ such that $f(x) - v_2 \in \beta$. Then the point $(x - v_1, f(x) - v_2)$ is in $V_1 \times \beta$. Now we choose a point p in the relative interior of τ and a real number $\lambda \gg 0$. Since $(x - v_1, f(x) - v_2) + \lambda p$ is still in $V_1 \times \beta$ we can choose a cone $\alpha \in \mathcal{Y}^{(d_1+d_2-k)}$ that contains $(x - v_1, f(x) - v_2) + \lambda p$ and satisfies $\overline{\pi_2(\alpha)} = \beta$. Note that τ is a face of α as $\lambda \gg 0$.

To show the injectivity let α be a cone in the left-hand side set with $\overline{\pi_2(\alpha)} = \beta$. Then

there is an $x \in \sigma_1$ such that $(x - v_1, f(x) - v_2) \in \alpha$. As (v_1, v_2) is generic and thus $f(v_1)_i \neq (v_2)_i$, this implies that α is contained in a uniquely defined maximal cone of $\mathcal{H}_{f(x)_1 - y_1} \cap \dots \cap \mathcal{H}_{f(x)_{d_2} - y_{d_2}}$, which in turn implies that α is uniquely determined by its projection $\pi_1(\alpha)$. Now we observe that the dimension of the intersection of translations of subsets of linear spaces

$$(\text{id} \times f)(\sigma_1) \cap ((V_1 \times \beta) + (v_1, v_2))$$

is at most $d_1 - k = \dim(\tau)$. As this set is invariant under adding elements of τ and $\tau \leq \alpha$, this uniquely determines $\pi_1(\alpha)$ and the assignment is injective.

Collecting our results we obtain that the weight of $\pi_1(\tau)$ in f^*C is

$$\omega_{f^*C}(\pi_1(\tau)) = \omega(\tau) = \sum_{\sigma_1 \in \Delta_1^{(d_1)}: \pi_1(\tau) \leq \sigma_1} \sum_{\beta \in \mathcal{C}^{(d_2-k)}: f(\pi_1(\tau)) \subseteq \beta} m_{\sigma_1, \beta}^{\pi_1(\tau)} \cdot \omega_C(\beta).$$

□

We now analyse the meaning of pull-backs in the case of modifications.

Lemma 3.6.17. *Let Q , M and N be matroids and let e be an element in Q that is not a coloop such that $\{e\}$ is a flat in Q and $Q \setminus e = M$, $Q/e = N$. Consider the corresponding projection $\pi : B(Q) \rightarrow B(M)$ and let φ be the modification function on $B(M)$ (as described in proposition 3.2.12). For any subcycle C of $B(M)$, let \tilde{C} be the modification of C along (the restriction to C of) φ (cf. definition 1.2.7). Then the equality*

$$\tilde{C} = \pi^*C$$

holds.

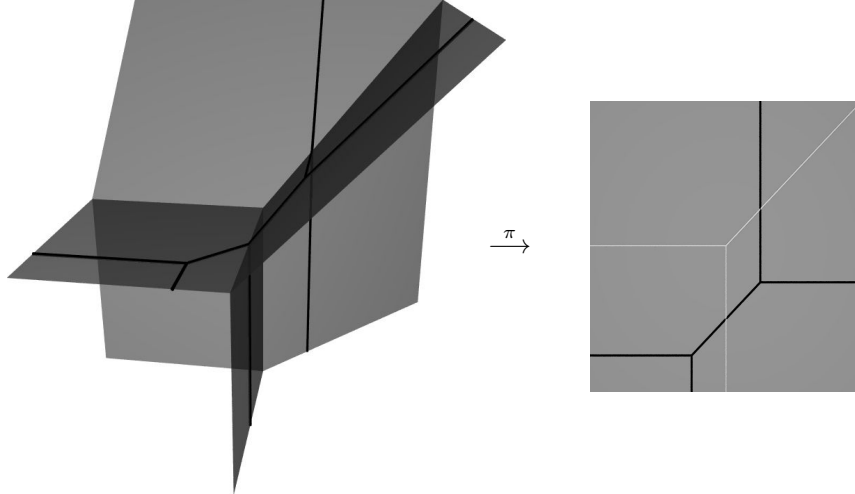

Modification of a cycle and its intersection with $B(N)$

PROOF. In order to ease the notations, we assume that $e = 1$. We set $n := |E(M)|$. Let $p : \mathbb{R}^{n+1} \times \mathbb{R}^n \rightarrow \mathbb{R}^{n+1}$ be the projection to the first factor and let $\tilde{\pi} : \mathbb{R}^{n+1} \rightarrow \mathbb{R}^n$ be the projection that forgets the first coordinate (that means π is the restriction of $\tilde{\pi}$ to $B(Q)$). As $B(Q)$ is the modification of $B(M)$ along φ , the definition of modifications in example 1.2.7 implies that

$$\pi^*C = p_*(\Gamma_\pi \cdot B(Q) \times C) = p_*(\Gamma_\pi \cdot (p^* \max\{\tilde{\pi}^*\varphi, x_1\} \cdot (\mathbb{R} \times B(M) \times C))),$$

where x_1 is the coordinate that describes \mathbb{R} . Now let $\Psi := \varphi_1 \cdots \varphi_{r(M)}$ be the product of the rational functions of corollary 3.3.2 that cut out the diagonal $\Delta_{B(M)}$. Note that all φ_i

have natural extensions to $\mathbb{R}^n \times \mathbb{R}^n = B(U_{n,n} \oplus U_{n,n})$; hence this is also true for Ψ . We have seen in the proof of theorem 3.6.3 for matroid varieties that

$$\Gamma_\pi = (\pi \times \text{id})^* \Delta_{B(M)} = (\tilde{\pi} \times \text{id})^* \Psi \cdot B(Q) \times B(M).$$

Plugging this into the above equation and using the associativity and commutativity of intersecting with piecewise polynomials, we see that $\pi^* C$ is equal to

$$\begin{aligned} & p_*(p^* \max\{\tilde{\pi}^* \varphi, x_1\} \cdot (\tilde{\pi} \times \text{id})^* \Psi \cdot (\mathbb{R} \times B(M) \times C)) \\ = & \max\{\tilde{\pi}^* \varphi, x_1\} \cdot p_*((\tilde{\pi} \times \text{id})^* \Psi \cdot (\mathbb{R} \times B(M) \times C)), \end{aligned}$$

which means that showing $p_*((\tilde{\pi} \times \text{id})^* \Psi \cdot (\mathbb{R} \times B(M) \times C)) = \mathbb{R} \times C$ is all we need to finish our proof. This can be easily seen as

$$(\tilde{\pi} \times \text{id})^* \Psi \cdot (\mathbb{R} \times B(M) \times C) = \mathbb{R} \times \Psi \cdot (B(M) \times C) = \mathbb{R} \times \Delta_C.$$

□

Applying this lemma to a whole series of modifications and using theorem 3.6.3(3), we get the following corollary.

Corollary 3.6.18. *Let $B(Q)$ and $B(M)$ be matroid varieties of the same dimension such that $Q \setminus R = M$ for a suitable independent flat R of Q . Let*

$$B(Q) = B(M_0) \xrightarrow{\pi_1} B(M_1) \xrightarrow{\pi_2} \dots \xrightarrow{\pi_{|R|}} B(M_{|R|}) = B(M)$$

be a series of projections each forgetting one coordinate of R . Let C be a cycle in $B(M)$ and let \tilde{C} be its repeated modification along the modification functions corresponding to the projections $\pi_1, \dots, \pi_{|R|}$. Then

$$\tilde{C} = \pi_1^* \dots \pi_{|R|}^* C = (\pi_{|R|} \circ \dots \circ \pi_1)^* C = \pi_R^* C$$

is in fact independent of the chosen series of modifications.

Moreover, let $B(N) \subseteq B(M)$ be two matroid varieties and let Q be the matroid of the proof of proposition 3.2.7 satisfying $Q \setminus R = M$ and $Q/R = N$. Let C be any cycle in $B(M)$. Then the intersection product $B(N) \cdot C$ can be computed as $(\pi^ C)^{\cap R}$, where $\pi : B(Q) \rightarrow B(M)$. In other words, we get $B(N) \cdot C$ by performing a series of modifications that lift C to a cycle in $B(Q)$, and then intersecting with a boundary part.*

3.7. Rational equivalence on matroid varieties

The aim of this section is to extend the known results about rational equivalence on vector spaces to matroid varieties modulo lineality spaces. Namely, we show that every subcycle of a matroid variety modulo lineality space is rationally equivalent to its recession cycle and that intersection products are compatible with rational equivalence. Moreover, we combine this with the results of the previous section to show the equivalence of our intersection product and the intersection product of [Sha].

We show in the next proposition that rational equivalence is compatible with dividing out a lineality space. This will be used to see that rational equivalence is also compatible with intersection products and pull-backs of cycles.

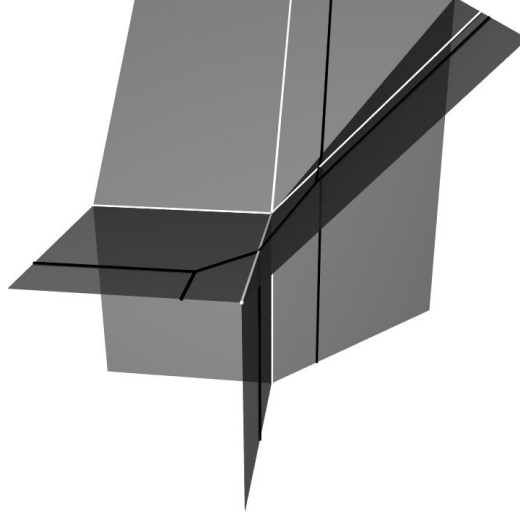

A curve on $B(U_{3,4})/L$ and its recession cycle.

Proposition 3.7.1. *Let X be a cycle with lineality space L . Let C be a subcycle of X also having lineality space L . Then C is rationally equivalent to zero on X if and only if C/L is rationally equivalent to zero on X/L .*

PROOF. As X is isomorphic to $X/L \times L$, it suffices to show that $C/L \times L$ is rationally equivalent to zero on $X/L \times L$ if and only if C/L is rationally equivalent to zero on X/L . The if-implication is an immediate consequence of the second part of lemma 1.4.5. So let us assume that $C/L \times L$ is rationally equivalent to zero. That means by definition that there are a morphism $f : A \rightarrow X/L \times L$ and a bounded rational function φ on A such that $f_*(\varphi \cdot A) = C/L \times L$. Let $\pi_{X/L} : X/L \times L \rightarrow X/L$ and $\pi_L : X/L \times L \rightarrow L$ be the projections to the respective factor. We choose a piecewise polynomial h on L such that $h \cdot L = \{0\}$. Now we just replace A by $A' := f^* \pi_L^* h \cdot A$ and check by projection formula that $(\pi_{X/L} \circ f)_*(\varphi \cdot A') = C/L$ holds. \square

Remark 3.7.2. Note that on matroid varieties modulo lineality spaces $B(M)/L$, intersection products and pull-backs of cycles are compatible with rational equivalence. In other words, if C and C' are cycles in $B(M)/L$ with $C \sim C'$, then also $f^*C \sim f^*C'$ and $C \cdot D \sim C' \cdot D$ for any morphism $f : B(N)/K \rightarrow B(M)/L$ and any cycle D in $B(M)/L$. This follows from the fact that cross products, intersections with rational functions as well as push-forwards are compatible with rational equivalence (cf. lemma 1.4.5) together with the previous proposition.

In order to prove that every cycle in $B(M)/L$ is rationally equivalent to its recession cycle, we introduce some more notation and prove the following lemmas.

Notation 3.7.3. If a is an element of the matroid M , we denote the corresponding projection $B(M) \rightarrow B(M \setminus a)$ by π_a . Furthermore, if \mathcal{F} is a chain of flats in M , then $\mathcal{F} \setminus a$ denotes the chain of flats in $M \setminus a$ obtained by intersecting each flat of \mathcal{F} with $E(M) \setminus a$.

Lemma 3.7.4. *Let $a, b \in E(M)$ be no coloops and assume that $\{b\}$ is a flat. Let C be a subcycle of $B(M)$ with $\pi_a_* C = 0$. Then $\pi_a^* \pi_b^* \pi_b_* C = 0$.*

PROOF. We choose a polyhedral structure \mathcal{C} of C which is compatible with the morphisms π_a, π_b and each of whose cells is contained in some cone of $B(M)$. As $\pi_a_* C = 0$ we know that every cell of \mathcal{C} is contained in a maximal cone $\langle \mathcal{F} \rangle$ of $B(M)$ satisfying $F_{i+1} = F_i \cup a$ for some i (cf. lemma 3.2.11). In order to simplify the notations we assume

that $b = |E(M)|$. Let φ be the piecewise linear function on $\mathcal{B}(M \setminus b)$ which satisfies for all flats G of $M \setminus b$ that

$$\varphi(V_G) = \begin{cases} -1, & \text{if } b \in \text{cl}_M(G) \\ 0, & \text{else} \end{cases}.$$

It follows from proposition 3.2.12 that $B(M)$ is the modification of $B(M \setminus b)$ along the rational function φ . Hence $\pi_b^* \pi_{b*} C$ is the modification of $\pi_{b*} C$ along φ (cf. lemma 3.6.17). It is easy to see that φ is given on a cone $\langle \mathcal{G} \rangle$ of $\mathcal{B}(M \setminus b)$ by

$$\varphi|_{\langle \mathcal{G} \rangle}(x_1, \dots, x_{b-1}) = x_p, \text{ with } p \in G_{z+1} \setminus G_z \text{ and } z \text{ s.t. } b \in \text{cl}_M(G_{z+1}) \setminus \text{cl}_M(G_z).$$

We claim that for a chain of flats \mathcal{F} in M satisfying $F_{i+1} = F_i \cup a$ for some i , the restriction of φ to $\langle \mathcal{F} \setminus b \rangle$ does not depend on x_a : Assume the contrary is true; then our description of φ implies that

$$b \in \text{cl}_M(F_{i+1} \setminus b) \text{ and } b \notin \text{cl}_M(F_i \setminus b).$$

Note that $\text{cl}_M(F_{i+1} \setminus b) \subseteq F_{i+1}$ and $\text{cl}_M(F_i \setminus b) \subseteq F_i$; thus $\text{cl}_M(F_i \setminus b) = F_i \setminus b$ and $b \in F_{i+1}$. As $F_{i+1} = F_i \cup a$, this implies that $b \in F_i$. Now F_i and $\text{cl}_M(F_i \setminus b \cup a) = F_{i+1}$ are both minimal flats containing the flat $F_i \setminus b$. But this is a contradiction since $F_i \subsetneq F_{i+1}$.

Let σ be a maximal cell of $\pi_b^* \pi_{b*} \mathcal{C}$ of the form $(\text{id} \times \varphi)(\pi_b(\tau))$, where τ is a maximal cell of \mathcal{C} . We can assume that the restriction of π_a to σ is injective (otherwise $\pi_a(\sigma)$ does not contribute to the push-forward). Since $\varphi|_{\pi_b(\tau)}$ does not depend on the a -th coordinate, we can conclude that $\alpha := \pi_{\{a,b\}}(\sigma)$ has the same dimension as σ . Let $\sigma_1, \dots, \sigma_p$ be the cells of \mathcal{C} mapped to α by $\pi_{\{a,b\}}$. As π_b is injective on σ_i , the cell σ_i turns into the cell

$$\tilde{\sigma}_i := \{(x_1, \dots, x_{b-1}, \varphi(x_1, \dots, x_{b-1})) : \exists x_b : (x_1, \dots, x_b) \in \sigma_i\}$$

in the cycle $\pi_b^* \pi_{b*} C$. The $\tilde{\sigma}_i$ are exactly the cells of $\pi_b^* \pi_{b*} \mathcal{C}$ mapped to $\pi_a(\sigma)$ by π_a . Since $\pi_{\{a,b\}*} C = 0$, we can conclude that $\pi_a(\sigma)$ has weight 0 in $\pi_{a*} \pi_b^* \pi_{b*} C$.

Now, the claim follows from the balancing condition. \square

Lemma 3.7.5. *Let C be a subcycle of a matroid variety $B(M)$. Assume that $B(M) \neq \mathbb{R}^{|E(M)|}$. If $\pi_{a*}(C) = 0$ for all $a \in E(M)$ that are not coloops of M , then $A = 0$.*

PROOF. We choose a polyhedral structure \mathcal{C} of C such that every cell of \mathcal{C} is contained in a cone of $\mathcal{B}(M)$. Let $\mathcal{F} = (\emptyset \subsetneq F_1 \subsetneq \dots \subsetneq F_{r(M)-1} \subsetneq E(M))$ be an arbitrary maximal chain of flats of M . We choose i such that $|F_{i+1} \setminus F_i| > 1$ and choose $a \in F_{i+1} \setminus F_i$. The maximality of \mathcal{F} implies that a is not a coloop. As π_a is generically one-to-one (lemma 3.2.11) and its restriction to $\langle \mathcal{F} \rangle$ is injective, $\pi_{a*} C = 0$ implies that there is no cell $\sigma \in \mathcal{C}$ whose relative interior is contained in the relative interior of $\langle \mathcal{F} \rangle$.

Now we assume there is a cell σ of \mathcal{C} whose relative interior is contained in the relative interior of a codimension 1 cone $\langle \mathcal{G} \rangle$ of $\mathcal{B}(M)$. Let $\mathcal{F} = (\emptyset \subsetneq F_1 \subsetneq \dots \subsetneq F_{r(M)-1} \subsetneq E(M))$ be a maximal superchain (of flats) of \mathcal{G} . As before we choose $a \in F_{i+1} \setminus F_i$, with i satisfying $|F_{i+1} \setminus F_i| > 1$. Only cells of \mathcal{C} contained in $\langle \mathcal{G} \rangle$ or a facet adjacent to $\langle \mathcal{G} \rangle$ can potentially be mapped to $\pi_a(\sigma)$ by π_a . The first part of the proof thus implies that

$$0 = \omega_{\pi_{a*} C}(\pi_a(\sigma)) = \omega_C(\sigma).$$

Continuing this way, we see that $C = 0$. \square

Theorem 3.7.6. *Every subcycle C of a variety $B(M)/L$ is rationally equivalent (on $B(M)/L$) to its recession cycle $\delta(C)$.*

PROOF. By proposition 3.7.1 it suffices to show the statement for matroid varieties $B(M)$.

We first consider the case where $\{a\}$ is a flat for every $a \in E(M)$. We use induction on the codimension of $B(M)$. The induction start ($B(M) = \mathbb{R}^n$) is covered by theorem 1.4.7. We show that C is rationally equivalent on $B(M)$ to a fan cycle: After renaming the elements,

we can assume that $\{1, \dots, k\}$ is the set of elements of $E(M)$ that are not coloops. For $i \in \{1, \dots, k\}$ we set

$$C_0 := C, \quad C_i := C_{i-1} - \pi_i^*(\pi_{i*}C_{i-1} - \delta(\pi_{i*}C_{i-1})).$$

By induction $\pi_{i*}C_{i-1}$ is rationally equivalent to $\delta(\pi_{i*}C_{i-1})$. As pulling back preserves rational equivalence, it follows that C_i is rationally equivalent to C_{i-1} . We set

$$N_0 := C, \quad N_i := N_{i-1} - \pi_i^*\pi_{i*}N_{i-1},$$

and

$$F_0 := 0, \quad F_i := F_{i-1} + \pi_i^*\delta(\pi_{i*}N_{i-1}).$$

It is easy to see that for all i the cycle F_i is a fan cycle, $C_i = N_i + F_i$, and $\pi_{i*}N_i = 0$. Lemma 3.7.4 implies that $\pi_{i*}N_k = 0$ for all i ; thus $N_k = 0$ by lemma 3.7.5. Therefore, C is rationally equivalent to the fan cycle F_k . As $\delta(C)$ is the only fan cycle which is rationally equivalent to C on \mathbb{R}^n (theorem 1.4.7), we can conclude $F_k = \delta(C)$.

The general case follows from the observation that the projection $\pi_R : B(M) \rightarrow B(M \setminus R)$ is an isomorphism for $R = \text{cl}_M(\{a\}) \setminus a$. \square

Summarising the results of theorem 3.7.6 and remark 3.7.2 we obtain the following corollary.

Corollary 3.7.7. *The map*

$$\bigoplus_{d \in \mathbb{N}} Z_d(B(M)/L) \rightarrow \bigoplus_{d \in \mathbb{N}} Z_d^{\text{fan}}(B(M)/L), \quad C \mapsto \delta(C)$$

is a morphism of graded rings and induces a ring isomorphism

$$\bigoplus_{d \in \mathbb{N}} Z_d(B(M)/L) / \sim_{\text{rat}} \rightarrow \bigoplus_{d \in \mathbb{N}} Z_d^{\text{fan}}(B(M)/L).$$

The next example answers the question of existence of lines of negative self-intersection in smooth fan surfaces.

Example 3.7.8. Let M be a matroid of rank 3 and $B(M)/L$ the corresponding tropical surface. As every line is rationally equivalent to a fan line $B(N)/L$ on $B(M)/L$, example 3.3.14 gives the self-intersection of any line on $B(M)/L$. For example, for every integer p with $-\frac{n-1}{2} \leq p \leq 1$ we can find a line on L_2^n which has self-intersection p . The other extreme is the Fano matroid F_7 which does not have a pair of disjoint flats of rank 2; hence all lines on $B(F_7)$ have self-intersection 0 or 1.

We can now prove that our intersection product coincides with the intersection product of [Sha]. The key ingredients are the fact that modifications can be expressed as pull-backs (lemma 3.6.17), the ability to move cycles without changing the class of the intersection product (as long as they do not leave the ambient cycle) and the locality of the intersection product.

Theorem 3.7.9. *Let $B(M)$ be a matroid variety and let C, D be two cycles in $B(M)$. We denote by $C.D$ the recursive intersection product defined in [Sha, definition 3.6]. Then this intersection product coincides with the one defined in definition 3.3.3, i.e.*

$$C.D = C \cdot D.$$

PROOF. The intersection product $C.D$ of [Sha, definition 3.6] is defined recursively via modifications and projections. Eventually, the recursion uses the known intersection product on \mathbb{R}^n . As both definitions agree on \mathbb{R}^n (cf. remark 1.3.13) it remains to check that our definition satisfies the recursion formula used in [Sha] to reduce the intersection product on $B(M)$ to intersection products on $B(M \setminus a)$ and $B(M/a) \times \mathbb{R}$, where $\{a\}$ is a flat of rank 1 which is not a coloop. Note that this reduction step decreases the codimension

of the ambient cycle in the first case and increases the dimension of the lineality space in the second case, so that one really ends up with an intersection product in \mathbb{R}^n eventually. Let $\pi : B(M) \rightarrow B(M \setminus a)$ be the projection forgetting the a -th coordinate and let φ be the corresponding modification function on $B(M \setminus a)$ (cf. proposition 3.2.12). The recursion formula is given by

$$C \cdot D = \pi^*(\pi_* C \cdot \pi_* D) + (\varphi \cdot \pi_* C \times \mathbb{R}) \cdot \Theta_D + \Theta_C \cdot (\varphi \cdot \pi_* D \times \mathbb{R}) + \Theta_C \cdot \Theta_D,$$

where $\Theta_C = C - \pi^* \pi_* C$, $\Theta_D = D - \pi^* \pi_* D$, and the first intersection product is in $B(M \setminus a)$, whereas the other products are computed in $B(M/a) \times \mathbb{R}$. This makes sense as $|\varphi \cdot \pi_* C| \subseteq |B(M/a)|$ and $|\Theta_C| \subseteq |B(M/a) \times \mathbb{R}|$ because Θ_C is in the kernel of π_* . Note that in [Sha] $\pi^* E$ is defined as the (restricted) modification of E , but by lemma 3.6.17 we know that we can also use our pull-back instead. Writing $C = \pi^* \pi_* C + \Theta_C$ and $D = \pi^* \pi_* D + \Theta_D$ we get

$$C \cdot D = \pi^* \pi_* C \cdot \pi^* \pi_* D + \pi^* \pi_* C \cdot \Theta_D + \Theta_C \cdot \pi^* \pi_* D + \Theta_C \cdot \Theta_D.$$

We first note that the first term equals $\pi^* \pi_* C \cdot \pi^* \pi_* D = \pi^*(\pi_* C \cdot \pi_* D)$ by theorem 3.6.3, property (2). It remains to show the equality of the other three intersection products: Since the cycles Θ_C and Θ_D can be moved into direction $V_{\{a\}}$ without leaving $B(M)$, $B(M/a) \times \mathbb{R} = \text{Star}_{B(M)}(p)$, where p is any interior point of $\langle \emptyset \subsetneq \{a\} \subsetneq E \rangle$, and the cycles $\pi^* \pi_* C$ and $(\varphi \cdot \pi_* C) \times \mathbb{R}$ agree on the faces of $B(M)$ containing $V_{\{a\}}$, the three equalities follow from the locality of the intersection product and corollary 3.7.7. So our intersection product satisfies the same recursion formula and therefore the definitions agree. \square

Remark 3.7.10. It was shown in [BS, theorem 3.7] that, for tropicalisations of linear surfaces, the tropical intersection product of [Sha] – and therefore also our intersection product – agrees with the algebraic intersection product computed in a suitable toric compactification of the surface. More precisely, if C_1 and C_2 are algebraic curves in a plane $X \subseteq (\mathbb{C}^*)^n$ that is not contained in any translation of a strict subtorus of $(\mathbb{C}^*)^n$, then one has the following equality of integers

$$\text{Trop}(C_1) \cdot_{\text{Trop}(X)} \text{Trop}(C_2) = \overline{C_1} \cdot_{\overline{X}} \overline{C_2},$$

where $\overline{C_1}, \overline{C_2}, \overline{X}$ are the closures of C_1, C_2, X in the toric compactification $X(\overline{\Sigma})$ of $(\mathbb{C}^*)^n$ obtained as explained hereafter: Let Δ be a primitive simplex that contains the convex hull of the support of a system of equations describing X . Let Σ be the complete, unimodular fan that is dual to Δ . Finally, one chooses a unimodular refinement $\overline{\Sigma}$ of Σ which contains all edges of $\text{Trop}(C_1)$ and $\text{Trop}(C_2)$.

This equality is extremely useful to answer relative realisability questions: As the above algebraic intersection product is non-negative for two distinct irreducible curves, one can conclude that an irreducible tropical fan curve D in $\text{Trop}(X)$, whose intersection product with the tropicalisation of some irreducible curve in X (that does not tropicalise to D) is negative, is not the tropicalisation of a curve in X (cf. [BS, corollary 3.10]). For example, one can deduce that the curve D of example 3.4.17 is not the tropicalisation of a curve in $V(x+y+z+1)$ because it intersects $\text{Trop}(x+y+z+1, x+y)$ with negative multiplicity. Further obstructions for relative realisability can be deduced from the above equality of intersection products by translating the adjunction formula to the tropical world; this was done in [BS, section 4].

3.8. Cocycles on smooth varieties and more pull-backs

In this section we analyse cocycles on smooth varieties. We start by proving that each subcycle of a matroid variety modulo lineality space can be cut out by a cocycle. As in the proof of theorem 3.7.6 the idea is to use matroid deletions to exploit the known \mathbb{R}^n case.

Thereafter, we show a Poincaré duality in codimension 1 and dimension 0 for smooth varieties.

Theorem 3.8.1. *For any $k \leq d := \dim(\mathbb{B}(M)/L)$, the following morphism is surjective:*

$$C^k(\mathbb{B}(M)/L) \rightarrow Z_{d-k}(\mathbb{B}(M)/L), \quad h \mapsto h \cdot \mathbb{B}(M)/L.$$

PROOF. We first consider the case where $L = \{0\}$ and $\{a\}$ is a flat for every $a \in E$. We use induction on the codimension of $\mathbb{B}(M)$: The induction start ($\mathbb{B}(M) = \mathbb{R}^n$) was proved in theorem 2.3.10. Let C be an arbitrary subcycle of $\mathbb{B}(M)$ of codimension k . After renaming the elements, we can assume that $\{1, \dots, p\}$ is the set of elements of E which are not coloops. For $i \in \{1, \dots, p\}$ we set

$$C_0 := C, \quad C_i := C_{i-1} - \pi_i^* \pi_{i*} C_{i-1},$$

where the $\pi_i : \mathbb{B}(M) \rightarrow \mathbb{B}(M \setminus i)$ denote the projections forgetting the i -th coordinate. The induction hypothesis allows us to choose cocycles $h_i \in C^k(\mathbb{B}(M \setminus i))$ such that $h_i \cdot \mathbb{B}(M \setminus i) = \pi_{i*} C_{i-1}$ for $i \in \{1, \dots, p\}$. Lemma 3.7.4 implies that $\pi_{i*} C_p = 0$ for all i ; thus $C_p = 0$ by lemma 3.7.5. It follows that

$$C = \sum_{i=1}^p \pi_i^* \pi_{i*} C_{i-1} = \sum_{i=1}^p \pi_i^* (h_i \cdot \mathbb{B}(M \setminus i)) = \left(\sum_{i=1}^p \pi_i^* h_i \right) \cdot \mathbb{B}(M).$$

As $\pi_R : \mathbb{B}(M) \rightarrow \mathbb{B}(M \setminus R)$ is an isomorphism for $R = \text{cl}_M(\{a\}) \setminus a$, this also implies the claim for arbitrary matroid varieties $\mathbb{B}(M)$.

Now let C be a subcycle of $\mathbb{B}(M)/L$. Since $\mathbb{B}(M) \cong \mathbb{B}(M)/L \times L$ we can choose a cocycle h with $h \cdot (\mathbb{B}(M)/L \times L) = C \times L$. It follows that $h \cdot (\mathbb{B}(M)/L \times \{0\}) = C \times \{0\}$. Therefore, we can conclude that $s^* h \cdot \mathbb{B}(M)/L = C$, where $s : \mathbb{B}(M)/L \rightarrow \mathbb{B}(M)/L \times L$ maps x to $(x, 0)$. \square

Remark 3.8.2. It follows in the same way that each fan cycle $D \in Z_{d-k}^{\text{fan}}(\mathbb{B}(M)/L)$ is cut out by a piecewise polynomial $h \in \text{PP}^k(\mathbb{B}(M)/L)$.

Remark 3.8.3. An alternative proof (in the case of a trivial lineality space $L = \{0\}$) has recently been found by Esterov in [Est, corollary 4.2]. His proof uses our representation of the diagonal as a product of rational functions to reduce to the case of a vector space.

The rest of the section is devoted to showing that the (surjective) morphism of theorem 3.8.1 is an isomorphism in some cases. It is an open question whether this holds in general.

Proposition 3.8.4. *Let $d := \dim(\mathbb{B}(M)/L)$. Then the following is an isomorphism:*

$$\text{PP}^1(\mathbb{B}(M)/L) / \text{LPP}^0(\mathbb{B}(M)/L) \rightarrow Z_{d-1}^{\text{fan}}(\mathbb{B}(M)/L), \quad h \mapsto h \cdot \mathbb{B}(M)/L.$$

PROOF. It remains to prove the injectivity. We can assume without loss of generality that $\{a\}$ is a flat in M for every $a \in E$. Let φ be a rational fan function with $\varphi \cdot \mathbb{B}(M) = 0$. The star $\text{Star}_{\mathbb{B}(M)}(p)$ around each point p in the relative interior of a maximal cone of $\mathbb{B}(M)$ is isomorphic to $\mathbb{R}^{\dim \mathbb{B}(M)}$; therefore, the locality of the intersection product (remark 2.1.22) and the \mathbb{R}^n case (theorem 2.3.10) imply that φ is linear around p . We can thus assume that φ is linear on the cones of $\mathbb{B}(M)$. It is sufficient to show by induction on the rank of F that $\varphi(V_F) = \sum_{a \in F} \varphi(V_{\{a\}})$ for all flats F of M . The claim is trivial for flats of rank 0 and 1. For a flat F of rank $i \geq 2$, we choose a chain of flats $\emptyset = F_0 \subsetneq F_1 \subsetneq \dots \subsetneq F_{i-2} \subsetneq F \subsetneq F_{i+1} \subsetneq \dots \subsetneq F_{\text{r}(M)} = E$, where each F_j has rank j . The corresponding codimension 1 cone τ has weight

$$0 = \sum_{\substack{G: \text{flat in } M \\ F_{i-2} \subsetneq G \subsetneq F}} \varphi(V_G) - \varphi(V_F) - (|\{G \text{ flat in } M : F_{i-2} \subsetneq G \subsetneq F\}| - 1) \cdot \varphi(V_{F_{i-2}})$$

in $\varphi \cdot B(M) = 0$. Therefore, the claim follows by induction. The $B(M)/L$ case is an immediate consequence of the $B(M)$ case. \square

Remark 3.8.5. The injectivity of intersecting with rational functions (i.e. of the map $\varphi \mapsto \varphi \cdot X$) can even be extended to the case of locally irreducible cycles X by using proposition 1.2.11. We preferred to give a matroid-theoretic proof here.

Proposition 3.8.6. *Let X be a locally irreducible fan cycle of dimension d which is connected in codimension 1. Then*

$$\mathrm{PP}^d(X)/\mathrm{LPP}^{d-1}(X) \rightarrow Z_0^{\mathrm{fan}}(X) = \mathbb{Z}, \quad h \mapsto h \cdot X$$

is an injective morphism of groups. As matroid varieties modulo lineality spaces are locally irreducible and connected in codimension 1, the above is an isomorphism of groups if $X = B(M)/L$.

For a proof we need the following lemma:

Lemma 3.8.7. *Let \mathcal{X} be a unimodular fan structure of a fan cycle X of dimension d . Let $\sigma_1, \sigma_2 \in \mathcal{X}^{(d)}$ be cones that have a common face $\tau \in \mathcal{X}^{(d-1)}$. If X is locally irreducible, then*

$$\omega_{\mathcal{X}}(\sigma_2) \cdot \Psi_{\sigma_1} - \omega_{\mathcal{X}}(\sigma_1) \cdot \Psi_{\sigma_2} = l \cdot \Psi_{\tau},$$

for some linear function l on X .

PROOF. Let $\sigma_3, \dots, \sigma_k > \tau$ be the remaining maximal cones in \mathcal{X} adjacent to τ . Let $v_1, \dots, v_{d-1}, w_1, \dots, w_k$ be the primitive integral vectors such that $\tau = \langle v_1, \dots, v_{d-1} \rangle$ and $\sigma_i = \langle v_1, \dots, v_{d-1}, w_i \rangle$. As

$$\omega_{\mathcal{X}}(\sigma_2) \cdot \Psi_{\sigma_1} - \omega_{\mathcal{X}}(\sigma_1) \cdot \Psi_{\sigma_2} = \Psi_{\tau} \cdot (\omega_{\mathcal{X}}(\sigma_2) \cdot \Psi_{w_1} - \omega_{\mathcal{X}}(\sigma_1) \cdot \Psi_{w_2}),$$

we need a linear function l satisfying

$$l|_{\sigma_1} = \omega_{\mathcal{X}}(\sigma_2) \cdot (\Psi_{w_1})|_{\sigma_1}, \quad l|_{\sigma_2} = -\omega_{\mathcal{X}}(\sigma_1) \cdot (\Psi_{w_2})|_{\sigma_2} \quad \text{and} \quad l|_{\sigma_i} = 0 \quad \text{for } i \geq 3.$$

The local irreducibility of X implies that $v_1, \dots, v_d, w_3, \dots, w_k, w_1$ are linearly independent. Thus there exists a linear function l such that $l(w_1) = \omega_{\mathcal{X}}(\sigma_2)$ and $l(v) = 0$ for $v \in \{v_1, \dots, v_{d-1}, w_3, \dots, w_k\}$. By the balancing condition $l(w_2) = -\omega_{\mathcal{X}}(\sigma_1)$; hence l satisfies the above conditions. \square

PROOF OF PROPOSITION 3.8.6. Let $h \in \mathrm{PP}^d(X)$ with $h \cdot X = 0$. We choose a unimodular fan structure \mathcal{X} of X such that $h \in \mathrm{PP}^d(\mathcal{X})$. Then there exist $a_{\sigma} \in \mathbb{Z}$ such that $\bar{h} = \sum_{\sigma \in \mathcal{X}^{(d)}} a_{\sigma} \cdot \bar{\Psi}_{\sigma}$ in $\mathrm{PP}^d(X)/\mathrm{LPP}^{d-1}(X)$. Fix a maximal cone $\alpha \in \mathcal{X}$. Since \mathcal{X} is connected in codimension 1 it follows by lemma 3.8.7 that $\bar{\Psi}_{\sigma} = \frac{\omega_{\mathcal{X}}(\sigma)}{\omega_{\mathcal{X}}(\alpha)} \cdot \bar{\Psi}_{\alpha}$ for all maximal cones σ . Hence $\bar{h} = \left(\sum_{\sigma \in \mathcal{X}^{(d)}} a_{\sigma} \cdot \frac{\omega_{\mathcal{X}}(\sigma)}{\omega_{\mathcal{X}}(\alpha)} \right) \bar{\Psi}_{\alpha}$, and lemma 2.1.19 implies that $\bar{h} = 0$. \square

We can prove the following corollary in a similar way as theorem 2.3.10.

Corollary 3.8.8. *Let X be a smooth tropical variety and $k \in \{1, \dim X\}$. Then the following is an isomorphism of groups:*

$$C^k(X) \rightarrow Z_{\dim X - k}(X), \quad h \mapsto h \cdot X.$$

PROOF. The injectivity follows directly from the local statement (proposition 3.8.4 resp. 3.8.6). Let $C \in Z_{\dim X - k}(X)$. We choose an open cover $\{V_i^j\}$ of X such that for all i, j we have $V_i^j \subseteq U_i$ and the weighted space $\phi_i(C \cap V_i^j)$ is (a translation of) an open fan cycle contained in $\phi_i(V_i^j)$. As the fan cycle associated to $\phi_i(V_i^j)$ is a matroid variety modulo lineality space, the local statement ensures that we can find piecewise polynomials

$h_i^j \in \text{PP}^k(\phi_i(V_i^j))$ cutting out $\phi_i(C \cap V_i^j)$. Then $h = \{(V_i^j, h_i^j \circ \phi_i)\} \in C^k(X)$ is a cocycle with $h \cdot X = C$. As in the proof of theorem 2.3.10 the difference of two of these local functions gives a zero (local) intersection on the overlaps of the open sets, so by the local statement h is indeed a cocycle. \square

Remark 3.8.9. Proving the injectivity of

$$\text{PP}^k(\mathbb{B}(M)/L)/L \text{PP}^{k-1}(\mathbb{B}(M)/L) \rightarrow Z_{\dim \mathbb{B}(M)/L-k}^{\text{fan}}(\mathbb{B}(M)/L)$$

is all that remains to be done in order to generalise corollary 3.8.8 to arbitrary codimensions k . Note that we also needed the injectivity of intersecting with piecewise polynomials to prove the surjectivity in the preceding proof.

Remark 3.8.10. It is well-known that the equality of Cartier and Weil divisors on smooth varieties also holds in classical algebraic geometry.

Remark 3.8.11. Let X be a tropical variety in a vector space that is locally irreducible and connected in codimension one. Let p be a point in X . By lemma 1.2.13 there is a convex rational function φ on $\text{Star}_X(p)$ such that $\varphi^{\dim X} \cdot \text{Star}_X(p) = \lambda \cdot \{0\}$ for some $\lambda \in \mathbb{Z}_{>0}$. We can thus use the argument of the proof of corollary 3.8.8 to conclude from proposition 3.8.6 that there is a unique cocycle on X that cuts out $\lambda \cdot p$.

We conclude the section by using corollary 3.8.8 to pull back points and codimension 1 cycles along morphisms with smooth targets. This could prove useful in enumerative geometry, where point conditions are often described as pull-backs of points along certain evaluation morphisms (see next section). Pull-backs of points will also be crucial to define families of smooth rational curves over smooth tropical varieties as morphisms of tropical varieties (with smooth target) all of whose fibres are smooth rational curves (plus two more technical conditions) in the next chapter.

Construction 3.8.12. Let C be a codimension k subcycle of a dimension d cycle Y satisfying $C^k(Y) \cong Z_{d-k}(Y)$. Let $f : X \rightarrow Y$ be a morphism. We can define the pull-back of C along f to be $f^*C := f^*h \cdot X$, where h is the (unique) cocycle satisfying $h \cdot Y = C$. If X and Y are smooth, this coincides with the pull-back of cycles of definition 3.6.1. Furthermore, pull-backs defined in this way clearly have the properties listed in example 3.6.1 and theorem 3.6.3. In particular, we can define pull-backs of points and codimension 1 cycles if Y is smooth, as well as pull-backs of arbitrary cycles if Y is a vector space. Unfortunately, we could not prove that $|f^*C| \subseteq f^{-1}|C|$ holds in general if the domain of f is not smooth (see also the following lemma).

Lemma 3.8.13. *Let $f : X \rightarrow Y$ be a morphism with a smooth target cycle Y . If $\varphi_1, \dots, \varphi_k$ are codimension 1 cocycles on Y such that all intermediate intersection products $\varphi_i \dots \varphi_k \cdot Y$ are locally irreducible (i.e. all local blocks are locally irreducible), then*

$$|f^*(\varphi_1 \dots \varphi_k) \cdot X| \subseteq f^{-1}|\varphi_1 \dots \varphi_k \cdot Y|.$$

In particular, if C is a subcycle of Y and either

- (1) $\dim C \in \{0, \dim Y - 1\}$, or
- (2) $C = \mathbb{B}(N)/L \subseteq \mathbb{R}^n/L = Y$,

*then $|f^*C| \subseteq f^{-1}|C|$.*

PROOF. As intersection products can be computed locally we can assume that $f : X \rightarrow Y$ is a linear morphism between fan cycles X and $Y = \mathbb{B}(M)/L$ and that $\varphi_1, \dots, \varphi_k$ are rational functions. We set $h_i := \varphi_i \dots \varphi_k$ and obtain by induction and proposition

1.2.11 that

$$\begin{aligned}
|f^* \varphi_i \cdot f^* h_{i+1} \cdot X| \subseteq |(f^* \varphi_i)|_{|f^* h_{i+1} \cdot X|} &\subseteq |(\varphi_i \circ f)|_{|f^{-1} h_{i+1} \cdot Y|} \\
&\subseteq f^{-1} |\varphi_i|_{|h_{i+1} \cdot Y|} \\
&= f^{-1} |\varphi_i \cdot h_{i+1} \cdot Y|,
\end{aligned}$$

where $|(\varphi_i)|_{|f^* h_{i+1} \cdot X|}$ denotes the domain of non-linearity of the restriction of the rational functions $f^* \varphi_i$ to the support of the cycle $f^* h_{i+1} \cdot X$. For $i = 1$ this implies the first claim. The second statement follows immediately from the first statement together with the fact that all intermediate intersection products in corollary 3.2.15 are matroid varieties and thus locally irreducible. \square

Remark 3.8.14. Let Y be a tropical variety in a vector space which is locally irreducible and connected in codimension one and let p be a point in Y . Let $f : X \rightarrow Y$ be a morphism. Choosing a suitable $\lambda \in \mathbb{Z}_{>0}$ and the uniquely defined cocycle h on Y with $h \cdot Y = \lambda \cdot p$, we can define the pull-back of p along f to be $f^* p := \frac{1}{\lambda} f^* h \cdot X$. Note that this pull-back might have rational weights: For example, the pull-back of any point p in $2 \cdot \mathbb{R}$ along the morphism $\mathbb{R} \rightarrow 2 \cdot \mathbb{R}, x \mapsto x$ is the point p with weight one half.

Intersection theory on the moduli space \mathcal{M}_n and families of curves

This chapter presents some applications of the intersection theory introduced in the previous chapters. We show that the moduli spaces of both, abstract and parametrised, rational tropical curves are isomorphic to matroid varieties modulo lineality spaces and thus admit a well-defined intersection product of cycles. In particular, this implies the (previously known) independence of the chosen points when counting rational curves through given points.

We also define families of n -marked smooth rational tropical curves over smooth varieties and construct a tropical fibre product in order to show that every morphism of a smooth variety X to the moduli space \mathcal{M}_n induces a family of n -marked curves over X . As the converse is also true – this was proved in [FH, theorem 4.5] – this gives \mathcal{M}_n the structure of a fine moduli space having the forgetful map as universal family, rather than just parametrising the set of n -marked abstract rational curves. We introduce an alternative, inductive way of constructing the moduli space \mathcal{M}_n as a tropical modification of the fibre product of two copies of \mathcal{M}_{n-1} over \mathcal{M}_{n-2} ; this is of course very similar to the construction of the classical moduli space $\overline{M}_{0,n}$.

The new elements of the first section are joint work with Johannes Rau published in [FR]. Sections two, three and four mainly consist of joint work with Simon Hampe publicised in [FH]; thereby I omitted proofs which were (completely or to a large extent) done by Simon Hampe. It is also worth mentioning that a preliminary definition of families of curves not using intersection theory has been introduced in my coauthor’s diploma thesis [Ham10] which acted as a starting point for our joint research. The last section is new and has not been published before.

4.1. Intersection product on the moduli space of rational curves

The aim of this section is to show that the moduli space \mathcal{M}_n of n -marked abstract rational curves is isomorphic to a matroid variety modulo lineality space and thus admits a well-defined intersection product of cycles. We start the section by briefly recalling the construction of \mathcal{M}_n .

For $n \geq 3$ an n -marked abstract rational tropical curve Γ is a tree all of whose n leaves have a unique marking in $\{1, \dots, n\}$, all of whose vertices have valence at least 3 and all of whose internal edges (i.e. edges that are not leaves) are equipped with a positive length. For $l_1, l_2, l_3 \in \mathbb{R}_{\geq 0}$, the following is an example of a 6-marked abstract rational curve.

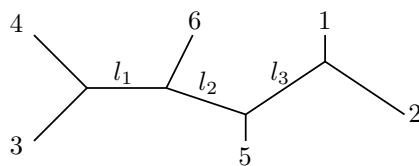

In [GKM09, section 3] the authors describe a simplicial tropical fan \mathcal{M}_n that parametrises n -marked abstract rational curves; the associated fan cycle is therefore called moduli space of n -marked abstract rational curves. By a slight abuse of notation we will refer to both the tropical fan and the associated fan cycle by \mathcal{M}_n . The relative interiors of cones in \mathcal{M}_n correspond to combinatorial types (i.e. the graphs without the metrics) of n -marked rational curves; their boundary consists of curves whose combinatorial type is obtained by inductively merging pairs of adjacent vertices of the initial combinatorial type (this can be regarded as shrinking some of the edge lengths to zero – the opposite operation is often referred to as resolving some vertices of valence greater than 3). The local coordinates (in each cone) are the lengths of the internal edges. As an n -marked rational curve has at most $n - 3$ internal edges (the maximum being attained if every vertex has valence 3) we see that \mathcal{M}_n has dimension $n - 3$. The edges of \mathcal{M}_n are generated by vectors $v_{I|n} := v_I$ (with $I \subsetneq \{1, \dots, n\}, 1 < |I| < n - 1$) corresponding to abstract curves with exactly one bounded edge of length 1 separating the leaves with labels in I from the leaves with labels in the complement of I . For $I_1, \dots, I_k \subsetneq \{1, \dots, n\}, \langle v_{I_1}, \dots, v_{I_k} \rangle$ is a cone in \mathcal{M}_n if and only if for all pairs i, j we have either $I_i \subseteq I_j$ or $I_i \subseteq \{1, \dots, n\} \setminus I_j$.

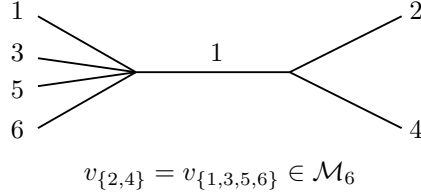

The idea used to give \mathcal{M}_n the structure of a tropical fan (with only trivial weights) is to identify an n -marked abstract rational curve with the vector in $\mathbb{R}^{\binom{n}{2}}$ whose entries are pairwise distances between its leaves. In the first curve depicted above we have for example that the distance $\text{dist}(3, 4)$ from leaf 3 to leaf 4 is 0, whereas $\text{dist}(3, 6) = \text{dist}(4, 6) = l_1$ and $\text{dist}(1, 3) = l_1 + l_2 + l_3$. The function dist_n is defined to map each n -marked abstract rational curve to its distance vector, i.e.

$$\Gamma \mapsto (\text{dist}_\Gamma(i, j))_{i < j}.$$

If $\phi_n : \mathbb{R}^n \rightarrow \mathbb{R}^{\binom{n}{2}}$ is the function which maps $x \in \mathbb{R}^n$ to $(x_i + x_j)_{i < j}$ and $q_n : \mathbb{R}^{\binom{n}{2}} \rightarrow Q_n := \mathbb{R}^{\binom{n}{2}} / \text{Im}(\phi_n)$ is the quotient map, then the composition $q_n \circ \text{dist}_n$ is an embedding whose image is the (support of the) tropical fan \mathcal{M}_n described above. One can easily see that every cone of \mathcal{M}_n is generated by the vectors v_I it contains. For example, the above curve is equal to $l_1 \cdot v_{\{3,4\}} + l_2 \cdot v_{\{3,4,6\}} + l_3 \cdot v_{\{1,2\}}$. Note that the underlying lattice Λ_n of the ambient space Q_n is the lattice generated by the v_I . We refer to [GKM09, section 3], [SS04, section 4] or [Mik07, section 2] for more details about the construction of \mathcal{M}_n .

Example 4.1.1. The moduli space \mathcal{M}_3 is just the origin, whereas \mathcal{M}_4 is isomorphic to the tropical standard line L_1^2 . Its rays are generated by the vectors $v_{\{1,2\}}, v_{\{1,3\}}$ and $v_{\{1,4\}}$ respectively.

The forgetful map $\text{ft}_0 := \text{ft} : \mathcal{M}_{n+1} \rightarrow \mathcal{M}_n$ forgetting the leaf with mark 0 (and then straightening two-valent vertices) is the morphism of tropical fan cycles induced by the projection $\pi : \mathbb{R}^{\binom{n+1}{2}} \rightarrow \mathbb{R}^{\binom{n}{2}}$ [GKM09, proposition 3.12]. Note that, in order to ease the notations, we equip \mathcal{M}_{n+1} with the markings $0, 1, \dots, n$, when we consider the forgetful map.

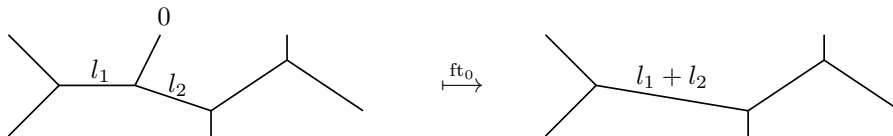

We need to introduce some more notation in order to state the main result of this section.

Definition 4.1.2. Let G be an undirected graph (without loops and multiple edges) with edge set E . A forest is a subgraph of G which does not contain any cycle. The graph G gives rise to a (graphic) matroid $M(G)$ on the ground set E whose independent sets are exactly the sets of edges of the forests of the graph G . We denote the matroid fan (resp. variety) associated to the matroid $M(G)$ by $\mathcal{B}(G)$ (resp. $B(G)$).

Example 4.1.3. Let K_n be the complete undirected graph with n vertices. It is easy to see that a subset F of the edge set $E = \{1, \dots, \binom{n}{2}\}$ of K_n is a flat in $M(K_n)$ if and only if F is the edge set of a vertex-disjoint union of complete subgraphs of K_n . The rank of $M(K_n)$ is $n - 1$.

Remark 4.1.4. It was proved in [Oxl92, proposition 5.1.2] that graphic matroids $M(G)$ are realisable over every field. This can be done by using the columns of the incidence matrix of any directed graph whose underlying undirected graph is G . In particular, $B(G)/L$, with $L = \mathbb{R} \cdot (1, \dots, 1)$, is the tropicalisation of a linear space.

It was shown in [AK06, section 4] that $B(K_{n-1})$ parametrises so-called equidistant $(n-1)$ -trees (i.e. rooted trees with $n - 1$ labelled leaves and lengths on each edge such that the distance from the root to any leaf is the same). We show in the next theorem that the moduli space \mathcal{M}_n is actually isomorphic (as a tropical cycle) to $B(K_{n-1})/L$, with $L = \mathbb{R} \cdot (1, \dots, 1)$.

Theorem 4.1.5. *The tropical cycles \mathcal{M}_n and $B(K_{n-1})/L$, with $L = \mathbb{R} \cdot (1, \dots, 1)$, are isomorphic. In particular, there is an intersection product of cycles on \mathcal{M}_n which has the properties listed in corollary 3.4.8.*

PROOF. We define the linear map f by

$$f : \mathbb{R}^{\binom{n-1}{2}}/L \rightarrow \mathbb{R}^{\binom{n}{2}}/\text{Im}(\phi_n)$$

$$(a_{i,j})_{i<j} \mapsto (b_{i,j})_{i<j}, \quad \text{with } b_{i,j} = \begin{cases} 0, & \text{if } n \in \{i, j\} \\ 2 \cdot a_{i,j}, & \text{else} \end{cases}.$$

The map f is well-defined (as $f(1, \dots, 1) = \phi_n(1, \dots, 1, -1)$) and injective. Since its domain and target space have the same dimension, it follows that f is a linear isomorphism. Let F be a flat of $M(K_{n-1})$. Then F is a vertex-disjoint union of complete subgraphs S_1, \dots, S_p of K_{n-1} , and

$$f(V_F) = (b_{i,j})_{i<j}, \quad \text{with } b_{i,j} = \begin{cases} -2, & \text{if } \{i, j\} \subseteq V(S_t) \text{ for some } t \\ 0, & \text{else} \end{cases},$$

where $V(S_t)$ denotes the set of vertices of the complete subgraph S_t . We define a vector $a \in \mathbb{R}^n$ by setting $a_i = 1$ if $i \in V(S_t)$ for some t , and $a_i = 0$ otherwise. Then

$$(f(V_F) + \phi_n(a))_{i,j} = \begin{cases} 0, & \text{if } \{i, j\} \subseteq V(S_t) \text{ for some } t, \text{ or } i, j \notin V(S_t) \text{ for all } t \\ 1, & \text{if } i \in V(S_t) \text{ for some } t, \text{ and } j \notin V(S_s) \text{ for all } s \\ 2, & \text{if there are } s \neq t \text{ with } i \in V(S_s), j \in V(S_t) \end{cases}.$$

The metric graph with n leaves associated to this vector, denoted by M_F , is depicted in the following picture.

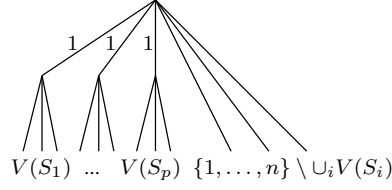

We see from this description that f also restricts to an isomorphism $\mathbb{Z}^{\binom{n-1}{2}}/L \rightarrow \Lambda_n$ of the underlying lattices: $\mathbb{Z}^{\binom{n-1}{2}}/L$ is mapped to Λ_n as $\mathbb{Z}^{\binom{n-1}{2}}/L$ is spanned by the V_F and $M_F = \sum_{i=1}^p v_{V(S_i)}$ is contained in Λ_n . Moreover, if $I \subsetneq \{1, \dots, n-1\}$ and F is the flat associated to the complete subgraph with vertex set I , then we have $v_I = M_F$. Hence all v_I lie in the image of the restriction of f to $\mathbb{Z}^{\binom{n-1}{2}}/L$.

It remains to check that f can be restricted to a bijection $B(K_{n-1})/L \rightarrow \mathcal{M}_n$: If F, G are flats corresponding to unions of the vertex-disjoint subgraphs S_1^F, \dots, S_p^F and S_1^G, \dots, S_q^G respectively, then F is a subset of G if and only if for each $i \in \{1, \dots, p\}$ there is a $j \in \{1, \dots, q\}$ such that $V(S_i^F) \subseteq V(S_j^G)$. As $M_F = \sum_{i=1}^p v_{V(S_i^F)}$, this implies that for each chain of flats \mathcal{F} in $M(K_{n-1})$ and each point $p \in \langle \mathcal{F} \rangle$ we have $f(p) \in \mathcal{M}_n$. Therefore, the image of $B(K_{n-1})/L$ under f is contained in \mathcal{M}_n . Since \mathcal{M}_n is irreducible (cf. [Rau09, page 88] or [GS, proposition 2.23]) and the dimensions agree, we actually have equality; i.e. $f(|B(K_{n-1})/L|) = |\mathcal{M}_n|$. Note that the last argument used the fact that f is bijective and thus $f(|B(K_{n-1})/L|) = |f_*(B(K_{n-1})/L)|$ is the support of a tropical cycle.

Hence, f induces a tropical isomorphism between $B(K_{n-1})/L$ and \mathcal{M}_n and thus \mathcal{M}_n inherits the intersection product of cycles from $B(K_{n-1})/L$. Note that this intersection product on \mathcal{M}_n is independent of the chosen isomorphism by remark 3.4.13. \square

Remark 4.1.6. Using the above representation of \mathcal{M}_n as $B(K_{n-1})/L$, the forgetful map $\text{ft} : \mathcal{M}_{n+1} \rightarrow \mathcal{M}_n$ is given by the projection $\pi : B(K_n)/L \rightarrow B(K_{n-1})/L'$ which forgets the coordinates belonging to edges of K_n that are incident to the forgotten vertex.

To actually count curves one often needs parametrised curves, that means abstract curves together with a morphism that maps the abstract curve into some \mathbb{R}^r . In the following we recall the construction of the moduli spaces $\mathcal{M}_n^{\text{lab}}(\mathbb{R}^r, \Delta)$ and use theorem 4.1.5 to equip them with an intersection product of cycles.

Construction 4.1.7. Let $N, n \in \mathbb{N}$ with $N > n$ and let $\Delta = (v_{n+1}, \dots, v_N) \in (\mathbb{Z}^r \setminus \{0\})^{N-n}$ such that the v_i sum up to 0. An n -marked labelled parametrised rational curve of degree Δ in \mathbb{R}^r is a tuple (C, f) consisting of an abstract N -marked rational curve C and a morphism $f : C \rightarrow \mathbb{R}^r$ that contracts (i.e. maps to a point) the ends in $\{1, \dots, n\}$ and for $i \in \{n+1, n+2, \dots, N\}$ maps the i -th end to an edge of direction v_i . One can give the set $\mathcal{M}_n^{\text{lab}}(\mathbb{R}^r, \Delta)$ of n -marked labelled parametrised rational curves of degree Δ in \mathbb{R}^r the structure of a tropical fan cycle by choosing one of the contracted ends as the anchor leaf in order to identify it with $\mathcal{M}_N \times \mathbb{R}^r$. The \mathbb{R}^r factor corresponds to the position of the anchor leaf, that means to the image of the anchor leaf under f . If $n = 2$ and Δ consists of d copies of each standard direction $(-1, 0), (0, -1), (1, 1)$, then one often writes $\mathcal{M}_n^{\text{lab}}(\mathbb{R}^2, d)$ for $\mathcal{M}_n^{\text{lab}}(\mathbb{R}^2, \Delta)$. We refer to [GKM09, proposition 4.7] for more details about this construction. Now theorem 4.1.5 gives us an isomorphism

$$\mathcal{M}_n^{\text{lab}}(\mathbb{R}^r, \Delta) \cong B(K_{N-1} \oplus U_{r+1, r+1})/L \times L',$$

where L and L' denote the natural one-dimensional lineality spaces. This implies that there is an intersection product of cycles on $\mathcal{M}_n^{\text{lab}}(\mathbb{R}^r, \Delta)$ that has the properties listed in theorem 3.5.6.

Next we recall the definition of the evaluation maps and briefly discuss the use of intersection theory in enumerative geometry.

Definition 4.1.8. For $i \in \{1, \dots, n\}$ the evaluation morphism ev_i is defined as

$$\text{ev}_i : \mathcal{M}_n^{\text{lab}}(\mathbb{R}^r, \Delta) \rightarrow \mathbb{R}^r, (C, f) \mapsto f(x_i),$$

where x_i denotes the i -th marked end. It follows easily from [GKM09, proposition 4.8] that after choosing the first marked end as our anchor leaf, the i -th evaluation map is

$$\begin{aligned} \text{ev}_i : \text{B}(K_{N-1})/L \times \mathbb{R}^r &\rightarrow \mathbb{R}^r, \\ ((a_{i,j})_{i < j}, b) &\mapsto b + \sum_{k=n+1}^{N-1} (a_{1,k} - a_{i,k})v_k. \end{aligned}$$

Remark 4.1.9. One uses the evaluation maps to define Gromov-Witten invariants: Let C_1, \dots, C_n be cycles in \mathbb{R}^r whose codimensions sum up to $N + r - 3$. The corresponding Gromov-Witten invariant is the degree of the zero-dimensional intersection product $(\text{ev}_1^* C_1) \cdots (\text{ev}_n^* C_n)$. It follows from theorem 3.7.6 and remark 3.7.2 that the Gromov-Witten invariants only depend on the rational equivalence classes of the C_i . In particular, if all C_i are points, then the Gromov-Witten invariants do not depend on the chosen points. (The independence of the chosen points is of course not a new result; it follows from Mikhalkin's correspondence theorem and has been proved by purely tropical means in [GM07a, theorem 4.8] and [GKM09, theorem 5.1].) We should point out that this intersection-theoretic definition does not require the points to be in general position. If they are in general position, then each point in $(\text{ev}_1^* C_1) \cdots (\text{ev}_n^* C_n)$ lies in the relative interior of a maximal cone and therefore its weight can be computed locally on \mathbb{R}^{N+r-3} . Using [Rau09, lemma 1.2.9], we notice that these local multiplicities agree with the multiplicities of [GKM09, corollary 2.26] and therefore for $r = 2$ also with Mikhalkin's well-known multiplicities (cf. [GKM09, remark 5.2], [Mik05, definitions 4.15 and 4.16]).

Example 4.1.10. Let $r = 2, d = 1, n = 2, (v_3, v_4, v_5) = (-e_1, -e_2, e_1 + e_2)$ and let P_1, P_2 be two points in \mathbb{R}^2 . We want to compute the degree of $(\text{ev}_1^* P_1) \cdot \mathcal{M}_2^{\text{lab}}(\mathbb{R}^2, 1) (\text{ev}_2^* P_2)$. As moving the points does not change the Gromov-Witten invariant we move both to the origin. We notice that ev_1 is just the projection to the second factor; hence we have

$$\text{ev}_1^* \{0\} = \mathcal{M}_5 \times \{0\}.$$

Since $\{0\} = \max\{y, 0\} \cdot \max\{x, 0\} \cdot \mathbb{R}^2$ we have

$$(\text{ev}_2^* \{0\}) \cdot (\text{ev}_1^* \{0\}) = ((\max\{a_{2,4} - a_{1,4}, 0\} \cdot \max\{a_{2,3} - a_{1,3}, 0\} \cdot \text{B}(K_4))/L) \times \{0\},$$

where $L = \mathbb{R} \cdot (1, \dots, 1)$. An easy calculation shows that $\max\{a_{2,3} - a_{1,3}, 0\} \cdot \text{B}(K_4)$ is equal to $\text{B}(M)$, where M is the rank two matroid that has rank one flats $\{(1, 4)\}, \{(2, 4)\}, \{(3, 4)\}$ and $\{(1, 2), (1, 3), (2, 3)\}$. Now $(\max\{a_{2,4} - a_{1,4}, 0\} \cdot \text{B}(M))/L$ is the origin with weight 1. This makes sense as there is exactly one tropical line through two given points (if they are in general position).

4.2. Tropical fibre products I

The aim of this section is to construct a tropical fibre product in the case that all involved cycles are smooth and one of the morphisms is locally surjective.

Definition 4.2.1. A morphism $f : X \rightarrow Y$ of tropical cycles is called locally surjective if for every point p in X and for some (and thus all) i, j with $p \in U_i^X$ and $f(p) \in U_j^Y$, the induced linear morphism of fan cycles

$$f_{i,j}^p : \text{Star}_{X_i}(\phi_i^X(p)) \rightarrow \text{Star}_{Y_j}(\phi_j^Y(f(p)))$$

is surjective. Here, as usually, $f_{i,j} = \phi_j^Y \circ f \circ (\phi_i^X)^{-1}$ and X_i, Y_j are the local blocks of the morphism f and the abstract cycles X, Y .

Remark 4.2.2. A morphism f of cycles in vector spaces is locally surjective if and only if the local morphism $f^p : \text{Star}_X(p) \rightarrow \text{Star}_Y(f(p))$ is surjective for all points p in X .

Lemma 4.2.3. *Let $f : X \rightarrow Y$ be a locally surjective morphism of tropical cycles in vector spaces. Then the following holds:*

- *Let \mathcal{X}, \mathcal{Y} be compatible polyhedral structures of X and Y . For $\tau \in \mathcal{X}$ we have*

$$f(U(\tau)) = U(f(\tau)), \text{ where } U(\tau) := \bigcup_{\sigma \in \mathcal{X}: \sigma \geq \tau} \text{Int}(\sigma).$$

In particular, f is an open map, i.e. maps open sets to open sets.

- *Let φ be a rational function on Y . Then the domain of non-linearity of $\varphi \circ f$ is equal to the preimage of the domain of non-linearity of φ , i.e.*

$$|\varphi \circ f| = f^{-1}(|\varphi|).$$

PROOF. The first part obviously follows from the local surjectivity of f . Note that the set of all possible $U(\tau)$ for all possible polyhedral structures of X forms a topological basis of the standard euclidean topology on $|X|$. For the second part it suffices to prove that φ is linear in some neighbourhood of $p \in Y$ if and only if $\varphi \circ f$ is linear in some neighbourhood of some point $q \in f^{-1}(p)$. But this is already clear from the first part. \square

Lemma 4.2.4. *Let $f : X \rightarrow Y$ be a locally surjective morphism from a tropical variety X to a smooth variety Y . Then the intersection-theoretic fibre $f^*(y)$ over each point y in Y has only positive weights and its support agrees with the set-theoretic fibre, which means*

$$|f^*(y)| = f^{-1}\{y\}.$$

PROOF. Let y be a point in Y and let x be a point in X with $f(x) = y$. As the intersection-theoretic computations are local, it suffices to show the claim for the induced morphism $f_{i,j}^x$ on the respective stars; that means we can assume that f is linear, X is a fan cycle, Y is a matroid variety modulo lineality space and $y = 0$. Let r be the dimension of Y . We choose convex rational functions φ_i such that $y = \varphi_1 \cdots \varphi_r \cdot Y$. This can be done by decomposing Y into a cross product of matroid varieties modulo 1-dimensional lineality spaces (cf. lemma 3.1.28) and then using lemma 3.1.24. We show by induction that $f^*\varphi_i \cdots f^*\varphi_r \cdot X$ is a cycle having only positive weights and satisfying

$$|f^*\varphi_i \cdots f^*\varphi_r \cdot X| = f^{-1}(|\varphi_i \cdots \varphi_r \cdot Y|),$$

which implies the claim because $f^*(y) = f^*\varphi_1 \cdots f^*\varphi_r \cdot X$: Since $f^*\varphi_{i-1}$ is convex and $f^*\varphi_i \cdots f^*\varphi_r \cdot X$ has only positive weights, it follows from proposition 1.2.11 that $f^*\varphi_{i-1} \cdot f^*\varphi_i \cdots f^*\varphi_r \cdot X$ has only positive weights and

$$|f^*\varphi_{i-1} \cdot f^*\varphi_i \cdots f^*\varphi_r \cdot X| = |(f^*\varphi_{i-1})|_{|f^*\varphi_i \cdots f^*\varphi_r \cdot X|},$$

where the right-hand side is the domain of non-linearity of the restriction of the rational function $f^*\varphi_{i-1}$ to (the support of) $f^*\varphi_i \cdots f^*\varphi_r \cdot X$. Lemma 4.2.3 for the induced morphism

$$\tilde{f} : f^*\varphi_i \cdots f^*\varphi_r \cdot X \rightarrow \varphi_i \cdots \varphi_r \cdot Y, \quad x \mapsto f(x)$$

and the induction hypothesis imply that the above coincides with

$$\tilde{f}^{-1}(|\varphi_{i-1}|_{|\varphi_i \cdots \varphi_r \cdot Y|}) = \tilde{f}^{-1}(|\varphi_{i-1} \cdot \varphi_i \cdots \varphi_r \cdot Y|) = f^{-1}(|\varphi_{i-1} \cdot \varphi_i \cdots \varphi_r \cdot Y|).$$

Note that our induction hypothesis (for stars around different points) and the locality of intersecting with rational functions (cf. proposition 1.2.9) ensure that \tilde{f} is locally surjective. \square

Remark 4.2.5. Lemma 4.2.4 ensures that all set-theoretic fibres of a locally surjective morphism are pure-dimensional and have the expected dimension. Therefore, local surjectivity might be seen as a tropical analogue of flatness.

Definition 4.2.6. Let $f : X \rightarrow Y$ and $f' : X' \rightarrow Y$ be morphisms of smooth varieties. Assume that f' is locally surjective. Recall that the diagonal $\Delta_Y \in Z_{\dim Y}(Y \times Y)$ is just the push-forward of Y along the morphism $y \mapsto (y, y)$. Then we define the tropical fibre product of X and X' over Y along the morphisms f, f' to be

$$X \times_Y X' := (f \times f')^*(\Delta_Y) \in Z_{\dim X + \dim X' - \dim Y}(X \times X').$$

Note that $f \times f' : X \times X' \rightarrow Y \times Y$ is a morphism of smooth varieties. Let $\pi_X, \pi_{X'}$ be the projections from $X \times X'$ to X and X' respectively. As the support of the pull-back satisfies

$$|(f \times f')^*(\Delta_Y)| \subseteq (f \times f')^{-1}(|\Delta_Y|) = \{(x, x') \in X \times X' : f(x) = f'(x')\},$$

we obtain the following commutative diagram of tropical morphisms:

$$\begin{array}{ccc} X \times_Y X' & \xrightarrow{\pi_{X'}} & X' \\ \downarrow \pi_X & & \downarrow f' \\ X & \xrightarrow{f} & Y \end{array}$$

Example 4.2.7. The following is an example of a fibre product that is not smooth and has non-trivial weights.

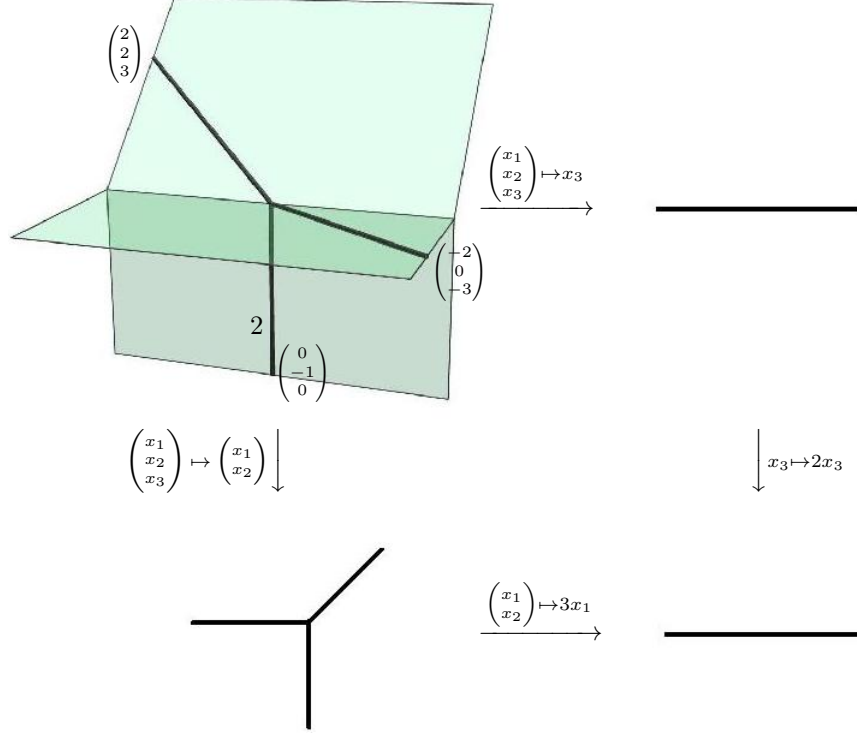

$$L_1^2 \times_{\mathbb{R}} \mathbb{R} = \max\{3x_1, 2x_3\} \cdot L_1^2 \times \mathbb{R}$$

Example 4.2.8. Let $f : L_1^2 \rightarrow \mathbb{R}$ be the projection to the first coordinate and $f' : \{0\} \hookrightarrow \mathbb{R}$ the inclusion morphism. Note that both morphisms are not locally surjective. Then $(f \times f')^*\Delta_{\mathbb{R}} = \{0\}$. Let P be a point. For $\lambda \in \{0, 1\}$, we consider the morphisms

$$g_{\lambda} : P \rightarrow L_1^2, P \mapsto \begin{pmatrix} 0 \\ -\lambda \end{pmatrix}, \text{ and } g' : P \rightarrow \{0\},$$

that satisfy $f \circ g_{\lambda} = f' \circ g'$. As $(f \times f')^*\Delta_{\mathbb{R}} = \{0\}$ there is obviously no pair of morphisms $a : P \rightarrow (f \times f')^*\Delta_{\mathbb{R}}$ and $\pi : (f \times f')^*\Delta_{\mathbb{R}} \rightarrow L_1^2$ such that $g_{\lambda} = \pi \circ a$ for both $\lambda = 0$ and $\lambda = 1$. Therefore, $(f \times f')^*\Delta_{\mathbb{R}}$ does not satisfy the universal property. In fact, in this

example, there is no tropical cycle that fulfils the universal property as the support of this cycle would need to be a half-bounded real interval which is of course impossible.

Remark 4.2.9. We will see later in theorem 4.2.11 that the assumption that f' is locally surjective is what we need to ensure that $X \times_Y X'$ is indeed a fibre product. Therefore, we only define it for this case.

Proposition 4.2.10. *Using the notations and assumptions of definition 4.2.6 we have*

$$\pi_X^*(p) = \{p\} \times f'^*(f(p)),$$

for each point p in X .

PROOF. In this proof, by abuse of notation, $\pi_X, \pi_{X'}, \pi_{X \times Y}, \pi_{X \times X'}$ denote projections from a product of X, Y, X' to the respective cycle. Let $h \in C^{\dim X}(X)$ be the (uniquely defined) cocycle such that $h \cdot X = p$ (corollary 3.8.8). By the projection formula and commutativity of intersection products (cf. proposition 2.3.9) we have

$$\pi_X^*(p) = \pi_X^* h \cdot (X \times_Y X') = (\pi_{X \times X'})_* \Gamma_{f \times f'} \cdot (\{p\} \times X' \times \Delta_Y).$$

Since we know by theorem 3.5.6(8) and lemma 3.6.5(1) that

$$\{p\} \times X' \times \Delta_Y = (\{p\} \times X' \times Y \times Y) \cdot (X \times X' \times \Delta_Y)$$

and $\Gamma_f \cdot (\{p\} \times Y) = \{(p, f(p))\}$, the above is equal to

$$\{p\} \times (\pi_{X'})_* (\Gamma_{f'} \times \{f(p)\}) \cdot (X' \times \Delta_Y).$$

Now it follows in an analogous way from theorem 3.5.6(8) and lemma 3.6.5(2) that the latter equals

$$\begin{aligned} & \{p\} \times (\pi_{X'})_* (\Gamma_{(f', f')} \cdot (X' \times Y \times \{f(p)\})) \\ &= \{p\} \times (\pi_{X'})_* (\Gamma_{f'} \cdot (X' \times \{f(p)\})) \\ &= \{p\} \times f'^*(f(p)). \end{aligned}$$

□

We are now ready to state the main theorem of this section.

Theorem 4.2.11. *If $f : X \rightarrow Y, f' : X' \rightarrow Y$ are morphisms of smooth tropical varieties and f' is locally surjective, then the support of $X \times_Y X'$ is*

$$|X \times_Y X'| = \{(x, x') \in X \times X' : f(x) = f'(x')\}.$$

In particular, $X \times_Y X'$ satisfies the universal property of fibre products.

PROOF. Combining lemma 4.2.4 and proposition 4.2.10 we immediately obtain that the support of $X \times_Y X'$ is $\{(x, x') \in X \times X' : f(x) = f'(x')\}$. For the second part, let Z be the domain of two tropical morphisms $g : Z \rightarrow X, g' : Z \rightarrow X'$ such that $f \circ g = f' \circ g'$. Then it is clear that $z \mapsto G(z) := (g(z), g'(z))$ is the only morphism from Z to $X \times_Y X'$ such that $\pi_X \circ G = g$ and $\pi_{X'} \circ G = g'$. □

Remark 4.2.12. Unfortunately, the tropical fibre product is not uniquely defined by the ‘‘tropical universal property’’: Changing the weights of $X \times_Y X'$ in such a way that it still satisfies the balancing condition produces a non-isomorphic cycle that still fulfils the ‘‘tropical universal property’’. This happens because a tropical morphism whose inverse is again a morphism is not necessarily an isomorphism. Therefore, one might try to give a slightly stronger definition of a tropical morphism, somehow respecting the weights, in order to fix this flaw.

We prove in the next propositions that fibre products are tropical varieties (i.e. all weights are positive) and the projections $\pi_X : X \times_Y X' \rightarrow X$ are locally surjective.

Proposition 4.2.13. *The fibre product $X \times_Y X'$ is a tropical variety.*

PROOF. Let p be a point in $X \times_Y X'$ whose weight is defined and whose image under $(\phi_i^X, \phi_{i'}^{X'})$ lies in the relative interior of a maximal cell for some i, i' . Note that it is sufficient to consider such points because weights are locally constant. We know by proposition 4.2.10 and lemma 4.2.4 that the pull-back $\pi_X^*(\pi_X(p))$ of the point $\pi_X(p)$ along the morphism $\pi_X : X \times_Y X' \rightarrow X$ has only positive weights. Let $\pi_{X_i} : X_i \times X'_{i'} \rightarrow X_i$ be the respective projection of the local blocks and set $n := \dim X + \dim X' - \dim Y$. The locality of the pull-back operation implies that the pull-back of the origin along the projection morphism

$$\pi^p := \pi_{X_i}^{(\phi_i^X, \phi_{i'}^{X'})}(p) : (\omega_{X \times_Y X'}(p) \cdot \mathbb{R}^n) \rightarrow \text{Star}_{X_i}(\phi_i^X(\pi_X(p)))$$

has only positive weights. As there are convex rational functions $\varphi_1, \dots, \varphi_{\dim X}$ on the smooth variety $\text{Star}_{X_i}(\phi_i^X(\pi_X(p)))$ that cut out the origin and

$$(\pi^p)^*(0) = \omega_{X \times_Y X'}(p) \cdot (\pi^p)^*\varphi_1 \cdots (\pi^p)^*\varphi_{\dim X} \cdot \mathbb{R}^n,$$

it follows from proposition 1.2.11 that the weight $\omega_{X \times_Y X'}(p)$ is positive. \square

Remark 4.2.14. If all fibres $f'^*(p)$ of f' have only trivial weights 1, then the previous proof even implies that all weights of $X \times_Y X'$ are 1.

Proposition 4.2.15. *The projection morphism $\pi_X : X \times_Y X' \rightarrow X$ is locally surjective.*

PROOF. As both, the definition of local surjectivity and the construction of the fibre product, are local we can assume that f and f' are linear morphisms of fan cycles in vector spaces. Let (p, p') be a point in $X \times_Y X'$. If v is a point in $\text{Star}_X(p)$, then $f(v)$ is a point in $\text{Star}_Y(f(p)) = \text{Star}_Y(f'(p'))$. Therefore, the local surjectivity of f' implies that there is a point $v' \in \text{Star}_{X'}(p')$ with $f'(v') = f(v)$. This in turn implies that (v, v') is a point in $\text{Star}_{X \times_Y X'}(p, p')$ which is obviously projected to v by π_X . Hence, π_X is locally surjective. \square

4.3. Families of curves and the forgetful map

The aims of this section are to introduce the notion of families of curves over smooth varieties in vector spaces and to prove that the forgetful map is a family of curves.

Definition 4.3.1. Let $n \geq 3$ and let B be a smooth tropical variety in a vector space. A locally surjective morphism $g : T \rightarrow B$ of tropical varieties in vector spaces is a prefamily of n -marked tropical curves if it satisfies the following conditions:

- (1) For each point b in B the cycle $g^*(b)$ is a smooth rational tropical curve with exactly n unbounded edges called the leaves of $g^*(b)$ (cf. remark 3.8.12 and corollary 3.8.8).
- (2) The linear part of g at any cell τ in (some and thus any polyhedral structure of) T induces a surjective map $g_\tau : \Lambda_\tau \rightarrow \Lambda_{g(\tau)}$ on the corresponding lattices.

A tropical marking on a prefamily $g : T \rightarrow B$ is an open cover $\{U_\theta, \theta \in \Theta\}$ of B together with a set of integer affine linear maps $s_i^\theta : U_\theta \rightarrow T$ (with $i \in \{1, \dots, n\}$) such that the following holds:

- (1) For all $\theta \in \Theta$ and $i \in \{1, \dots, n\}$ we have $g \circ s_i^\theta = \text{id}_{U_\theta}$. In other words, s_i^θ maps each point $b \in U_\theta$ into the fibre $g^*(b)$.
- (2) For each $\theta \in \Theta$, each $b \in U_\theta$ and each leaf l of $g^*(b)$ there is exactly one $i \in \{1, \dots, n\}$ such that $s_i^\theta(b)$ is in the relative interior of l .
- (3) For any $\theta \neq \zeta \in \Theta$ and $b \in U_\theta \cap U_\zeta$, the points $s_i^\theta(b)$ and $s_i^\zeta(b)$ mark the same leaf of $g^*(b)$. Note that they do not have to coincide.

A family of n -marked tropical curves is a prefamily with a marking.

We call two families $g : T \rightarrow B$ and $g' : T' \rightarrow B$ equivalent if for any b in B the fibres $g^*(b), g'^*(b)$ are isomorphic as n -marked tropical curves.

Example 4.3.2.

- The morphism

$$\pi : L_1^n \times \mathbb{R} \rightarrow \mathbb{R}, (x_1, \dots, x_n, y) \mapsto y,$$

together with the trivial marking $y \mapsto (-e_i, y)$, $i = 0, 1, \dots, n$, is a family of $(n + 1)$ -marked curves. Here e_1, \dots, e_n forms the standard basis of \mathbb{R}^n and $e_0 := -(e_1 + \dots + e_n)$.

- Let the tropical curve X_1 be the sum of tropical cycles $(\mathbb{R} \times \{0\}) + (\{0\} \times \mathbb{R})$. We consider the morphism

$$\pi_1 : L_1^n \times X_1 \rightarrow \mathbb{R}, (x_1, \dots, x_n, y_1, y_2) \mapsto y_2.$$

Although $\pi_1^*(p) = L_1^n \times \{(0, p)\}$ for all points p in \mathbb{R} , π_1 is not a family of curves: for $q = ((0, \dots, 0), (-1, 0)) \in L_1^n \times X_1$ the map

$$\pi_1^q : \text{Star}_{L_1^n \times X_1}(q) \cong L_1^n \times \mathbb{R} \rightarrow \text{Star}_{\mathbb{R}}(0) \cong \mathbb{R}$$

is just the constant zero map. Geometrically, we see that the set-theoretic fibre $\pi_1^{-1}\{0\}$ is 2-dimensional. This illustrates the necessity of the local surjectivity without which π, π_1 would be equivalent families with completely different domains $L_1^n \times \mathbb{R}, L_1^n \times X_1$ (compare to remark 4.4.4).

Remark 4.3.3. One can show that for all cells τ in (a polyhedral structure of) T on which g is not injective, condition (2) on a prefamily follows from the other conditions (cf. [FH, lemma 5.17]). One needs condition (2) on all cells τ (including those on which g is injective) to show that the locally affine linear map $B \rightarrow \mathcal{M}_n$ induced by the family $T \rightarrow B$ is an integer map and thus a tropical morphism (cf. remark 4.4.4).

We proceed to show that the forgetful map $\text{ft} : \mathcal{M}_{n+1} \rightarrow \mathcal{M}_n$ is a family of n -marked curves. Therefore, we prove that it is locally surjective:

Lemma 4.3.4. *The morphism $\text{ft}^p : \text{Star}_{\mathcal{M}_{n+1}}(p) \rightarrow \text{Star}_{\mathcal{M}_n}(\text{ft}(p))$ is surjective for all points p in the moduli space \mathcal{M}_{n+1} . Hence the forgetful map is locally surjective.*

PROOF. Let C be the tropical curve corresponding to the point p in \mathcal{M}_{n+1} . Let p' be an arbitrary element of $\text{Star}_{\mathcal{M}_n}(\text{ft}(p))$. Then p' corresponds to a curve which is obtained from the curve corresponding to $\text{ft}(p)$ by changing the lengths of some edges (without contracting them) and resolving some higher-valent vertices. If we resolve the same vertices in C and change the edge lengths in the same way, we get a curve D corresponding to a point $q \in \text{Star}_{\mathcal{M}_n}(\text{ft}(p))$ such that $\text{ft}^p(q) = p'$. \square

We compute the fibres of the forgetful map in the following proposition.

Proposition 4.3.5. *Let $\text{ft} : \mathcal{M}_{n+1} \rightarrow \mathcal{M}_n$ be the forgetful map. Then for each point p in \mathcal{M}_n , the fibre $\text{ft}^*(p)$ is a smooth rational curve having n unbounded edges.*

Our proof makes use of the following lemma.

Lemma 4.3.6. *The edge $\mathbb{R}_{\geq 0} \cdot v_{\{0, n\}}$ has trivial weight 1 in the fibre $\text{ft}^*(0)$.*

PROOF. Using the isomorphism $f : B(K_n)/L \rightarrow \mathcal{M}_{n+1}$ introduced in theorem 4.1.5 we have to compute the fibre over the origin of the projection $\pi : B(K_n)/L \rightarrow B(K_{n-1})/L$ which forgets the coordinates $x_{0,i}$. Note that we gave K_n and K_{n-1} the respective vertex sets $\{0, 1, \dots, n-1\}$ and $\{1, \dots, n-1\}$ and that by abuse of notation we

denoted both lineality spaces by L . If $\tilde{\pi} : B(K_n) \rightarrow B(K_{n-1})$ is the “naturally lifted” projection, then proposition 3.6.7 states that $\pi^*(0) = (\tilde{\pi}^*L)/L$. This enables us to use lemma 3.1.24 to conclude that $\tilde{\pi}^*L = \varphi^{n-3} \cdot B(K_n)$, where $\varphi := \max\{x_{i,j} : 0 < i < j \leq n-1\}$. Let G be the flat of $M(K_n)$ corresponding to the complete subgraph with vertex set $\{1, \dots, n-1\}$. It is easy to see that φ is linear on the cones of $B(K_n)$ and that $\varphi(V_F) = -1$ if $F \in \{G, E(K_n)\}$, and $\varphi(V_F) = 0$ otherwise. A straightforward induction shows that the cone associated to $\mathcal{F} := (\emptyset \subsetneq F_1 \subsetneq \dots \subsetneq F_{n-3-k} \subsetneq G \subsetneq E(K_n))$, where $r(F_i) = i$, has weight 1 in $\varphi^k \cdot B(K_n)$. It follows that the edge $\mathbb{R}_{\geq 0} \cdot v_{\{0,n\}}$, which is the image of (the class of) the cone $\langle \emptyset \subsetneq G \subsetneq E(K_n) \rangle$ under the isomorphism f , has weight 1 in $\text{ft}^*(0)$. \square

PROOF OF PROPOSITION 4.3.5. We know from [Rau09, proposition 2.1.21] that for each p in \mathcal{M}_n there is a smooth rational irreducible curve C_p which has n unbounded ends and whose support $|C_p|$ is equal to the set-theoretic fibre $\text{ft}^{-1}\{p\}$. The edges of C_0 are simply $\mathbb{R}_{\geq 0} \cdot v_{\{0,i\}}$, with $i \in [n]$. Since

$$|\text{ft}^*(p)| \subseteq \text{ft}^{-1}\{p\} = |C_p|,$$

the irreducibility of C_p allows us to conclude that $\text{ft}^*(p) = \lambda_p \cdot C_p$ for some integer λ_p . Since any two points in \mathcal{M}_n are rationally equivalent by theorem 3.7.6 and the forgetful map is compatible with rational equivalence (remark 3.7.2), we conclude that $\text{ft}^*(p)$ and $\text{ft}^*(0)$ are rationally equivalent and thus $\lambda_p = \lambda_0$. This finishes the proof as $\lambda_0 = 1$ by the previous lemma. \square

As the forgetful map clearly fulfils the second axiom on a prefamily, the following corollary is a direct consequence of proposition 4.3.5 and lemma 4.3.4.

Corollary 4.3.7. *The forgetful map $\text{ft} : \mathcal{M}_{n+1} \rightarrow \mathcal{M}_n$ is a prefamily of n -marked tropical curves.*

In order to construct a marking on \mathcal{M}_n one considers the following bases W_i of the ambient space Q_n of \mathcal{M}_n : For $i \in \{1, \dots, n\}$ one sets

$$V_i := \{v_I : I \subsetneq \{1, \dots, n\} \setminus \{i\}, |I| = 2\},$$

chooses an arbitrary element $v_{I_0} \in V_i$ and defines

$$W_i := V_i \setminus \{v_{I_0}\}.$$

It was shown in [KM09, lemma 2.3] and [FH, section 4] that W_i is indeed a basis of Q_n for all i .

Proposition 4.3.8. *For all $\alpha > 0$ let*

$$U_\alpha := \left\{ \sum_{v_I \in \mathcal{M}_n} \lambda_I v_I : \lambda_I \geq 0, \sum \lambda_I < \alpha \right\} \cap |\mathcal{M}_n|.$$

For $\alpha > 0$ and $i \in \{1, \dots, n\}$ one sets

$$s_i^\alpha : U_\alpha \rightarrow \mathcal{M}_{n+1}, v \mapsto \alpha \cdot v_{\{0,i\}|_{n+1}} + A_i(v),$$

where $A_i : Q_n \rightarrow Q_{n+1}$ is the linear map defined by $A_i(v_{I|_n}) = v_{I|_{n+1}}$ for all $v_{I|_n} \in W_i$. Then $\{(U_\alpha, s_1^\alpha, \dots, s_n^\alpha) : \alpha > 0\}$ is a tropical marking of the forgetful map $\text{ft} : \mathcal{M}_{n+1} \rightarrow \mathcal{M}_n$ making it a family of n -marked rational tropical curves. Furthermore, the fibre over each point p in \mathcal{M}_n under the forgetful map is exactly the n -marked curve represented by that point.

PROOF. The first part was proved in [FH, proposition 4.9] and the second part in [Rau09, proposition 2.1.21(b)]. \square

Remark 4.3.9. One can show that the above marking is unique in the sense that for any two markings on the forgetful map there is a permutation on $\{1, \dots, n\}$ that identifies equally marked leaves. This was proved in [FH, proposition 4.10].

4.4. Morphisms into \mathcal{M}_n induce families of curves

We now apply our theory to assign a family of n -marked curves to each morphism from a smooth variety in a vector space to \mathcal{M}_n . We use this to give an alternative, inductive construction of \mathcal{M}_n . Let us first introduce some notation.

Notation 4.4.1. Let X be a smooth variety and $f : X \rightarrow \mathcal{M}_n$ a morphism. Then we denote by X^f the fibre product

$$X^f := X \times_{\mathcal{M}_n} \mathcal{M}_{n+1} \in Z_{\dim X+1}(X \times \mathcal{M}_{n+1})$$

along the morphisms f and $\text{ft} : \mathcal{M}_{n+1} \rightarrow \mathcal{M}_n$.

Remark 4.4.2. It follows from remark 4.2.14 and proposition 4.3.5 that X^f has only trivial weights 1.

We conclude in the following corollary that the projection $\pi_X : X^f \rightarrow X$ is a family of n -marked curves.

Corollary 4.4.3. *Let X be a smooth variety in a vector space. Each morphism $f : X \rightarrow \mathcal{M}_n$ induces a family of n -marked rational curves*

$$(\pi_X : X^f \rightarrow X, t_i^\alpha),$$

where $t_i^\alpha : f^{-1}(U_\alpha) \rightarrow X^f, x \mapsto (x, s_i^\alpha \circ f(x))$ and s_i^α is the marking on the universal family from proposition 4.3.8.

PROOF. The cycle X^f is a tropical variety by proposition 4.2.13 and π_X is locally surjective by proposition 4.2.15. Each fibre $\pi_X^*(p) = \{p\} \times \text{ft}^*(f(p))$ is a smooth rational curve with n leaves by propositions 4.2.10 and 4.3.5. It is obvious that π_X satisfies the second prefamily axiom and that t_i^α is indeed a marking. \square

Remark 4.4.4. The converse of corollary 4.4.3 is also true; namely every family of n -marked rational tropical curves over a smooth variety B in a vector space induces a morphism $B \rightarrow \mathcal{M}_n$. In fact these operations are inverse to each other; that means there is a one-to-one correspondence between families of n -marked curves over the smooth variety B (modulo equivalence) and morphisms from B to \mathcal{M}_n [FH, theorem 5.6].

For a family $g : T \rightarrow B$ one defines the map

$$d_g : B \rightarrow \mathbb{R}^{\binom{n}{2}}, b \mapsto (\text{dist}_{g^*(b)}(k, l))_{k < l},$$

where the length of the path from leaf k to leaf l on the fibre is determined in the following way: The length of a bounded edge $E = \text{conv}\{p, q\}$ is defined to be the positive real number α such that $q = p + \alpha \cdot v$, where v is the primitive lattice vector generating that edge.

It was proved in [FH, propositions 5.4 and 5.5] that the map $q_n \circ d_g : B \rightarrow \mathcal{M}_n$ is a morphism. (Lemma 4.2.4 is one of the ingredients of the proof.) Simon Hampe also showed that the domains T, T' of two equivalent families $g : T \rightarrow B, g' : T' \rightarrow B$ of n -marked rational curves are isomorphic if T or T' is smooth [FH, theorem 6.2].

Next, we compute the families induced by the identity and the forgetful morphism.

Example 4.4.5. Let $\text{id} : \mathcal{M}_n \rightarrow \mathcal{M}_n$ be the identity morphism. We know by theorem 4.2.11 that the support of $\mathcal{M}_n^{\text{id}}$ is

$$|\mathcal{M}_n^{\text{id}}| = \{(x, y) \in \mathcal{M}_n \times \mathcal{M}_{n+1} : x = \text{ft}(y)\}.$$

As all occurring weights are 1 (remark 4.4.2) this implies that

$$\mathcal{M}_{n+1} \rightarrow \mathcal{M}_n^{\text{id}}, y \mapsto (\text{ft}(y), y)$$

is an isomorphism which identifies the family $\pi_{\mathcal{M}_n} : \mathcal{M}_n^{\text{id}} \rightarrow \mathcal{M}_n$ induced by the identity with the the forgetful map $\text{ft} : \mathcal{M}_{n+1} \rightarrow \mathcal{M}_n$.

We prove in the following proposition that \mathcal{M}_{n+2} is the modification of the fibre product $\mathcal{M}_{n+1} \times_{\mathcal{M}_n} \mathcal{M}_{n+1}$ along its codimension 1 subcycle $\Delta_{\mathcal{M}_{n+1}}$. This leads to an alternative, inductive procedure of constructing \mathcal{M}_n : Knowing that \mathcal{M}_3 is the origin and \mathcal{M}_4 is L_1^2 , one can construct \mathcal{M}_5 using the following proposition and then obtain the forgetful map $\text{ft} : \mathcal{M}_5 \rightarrow \mathcal{M}_4$ using the previous example. Continuing this way, one can construct \mathcal{M}_n for all n . This approach is of course very similar to the construction of the classical moduli spaces $\overline{M}_{0,n}$ in [KV07, section 1.4].

Proposition 4.4.6. *Let $\pi_{\mathcal{M}_{n+1}} : \mathcal{M}_{n+1}^{\text{ft}} \rightarrow \mathcal{M}_{n+1}$ be the family of n -marked curves induced by the forgetful map $\text{ft} : \mathcal{M}_{n+1} \rightarrow \mathcal{M}_n$. Then the modification of $\mathcal{M}_{n+1}^{\text{ft}}$ along its codimension 1 subcycle $\Delta_{\mathcal{M}_{n+1}}$ is the moduli space of $(n+2)$ -marked abstract rational curves \mathcal{M}_{n+2} .*

PROOF. Let K_{n+1} be the complete graph on the vertex set $\{0, 1, \dots, n\}$. By proposition 3.2.12 it suffices to prove that $\mathcal{M}_{n+1}^{\text{ft}}$ is isomorphic to $B(M(K_{n+1}) \setminus (0, n))/L$ and that $\Delta_{\mathcal{M}_{n+1}}$ is isomorphic to $B(M(K_{n+1})/(0, n))/L$, where $L = \mathbb{R} \cdot (1, \dots, 1)$ and $(0, n)$ denotes the edge between 0 and n . We consider the injective linear map

$$\begin{aligned} f : \mathbb{R}^{\binom{n+1}{2}-1} &\rightarrow \mathbb{R}^{\binom{n}{2}} \times \mathbb{R}^{\binom{n}{2}} \\ (x_{i,j})_{0 \leq i < j \leq n : (i,j) \neq (0,n)} &\mapsto ((x_{i,j})_{0 \leq i < j \leq n-1}, (x_{i,j})_{1 \leq i < j \leq n}). \end{aligned}$$

Let $\pi_0, \pi_n : \mathbb{R}^{\binom{n+1}{2}} \rightarrow \mathbb{R}^{\binom{n}{2}}$ and $\tilde{\pi}_0, \tilde{\pi}_n : \mathbb{R}^{\binom{n}{2}} \rightarrow \mathbb{R}^{\binom{n-1}{2}}$ be the projections that forget all coordinates $x_{0,i}$ and $x_{i,n}$ respectively; in other words, they describe the forgetful maps ft_0, ft_n . Let $\pi_{(0,n)} : \mathbb{R}^{\binom{n+1}{2}} \rightarrow \mathbb{R}^{\binom{n+1}{2}-1}$ be the projection which forgets the coordinate $x_{0,n}$. With these notations we obviously have $f \circ \pi_{(0,n)} = (\pi_n, \pi_0)$. Thus we obtain

$$f_* B(M(K_{n+1}) \setminus (0, n)) = f_* \pi_{(0,n)*} B(K_{n+1}) = (\pi_n, \pi_0)_* B(K_{n+1}).$$

Therefore, we can conclude that

$$|f_* B(M(K_{n+1}) \setminus (0, n))| = \{(x, y) \in B(K_n) \times B(K_n) : \tilde{\pi}_0(x) = \tilde{\pi}_n(y)\}.$$

Here the first complete graph K_n has vertex set $\{0, 1, \dots, n-1\}$, whereas the second has vertex set $\{1, \dots, n\}$. As all occurring weights are 1, it follows by theorem 4.2.11 that $f_* B(M(K_{n+1}) \setminus (0, n))/L$ is isomorphic to $\mathcal{M}_{n+1}^{\text{ft}}$.

In order to prove the second part we notice that $B(M(K_{n+1})/(0, n))/L$ and $\Delta_{\mathcal{M}_{n+1}}$ are both matroid varieties modulo lineality spaces and have the same dimension. Therefore, it suffices to show that for every flat of $M(K_{n+1})/(0, n)$, $f(V_F)$ is in the diagonal of $B(K_n) \times B(K_n)$ after identifying the coordinates $x_{0,i}$ of the first $\mathbb{R}^{\binom{n}{2}}$ with the coordinates $x_{i,n}$ of the second to obtain the same set of coordinates in both factors. If F is a flat of $M(K_{n+1})/(0, n)$, then $F \cup (0, n)$ is a flat in K_{n+1} ; but this implies that $(0, i) \in F$ if and only if $(i, n) \in F$. Hence $f(V_F)$ lies in the diagonal. \square

Remark 4.4.7. The idea of the previous proposition is that two points in \mathcal{M}_{n+1} which have the same image under the forgetful map induce a point in \mathcal{M}_{n+2} . This $(n+2)$ -marked curve is obtained by adding both forgotten ends to the point in \mathcal{M}_n .

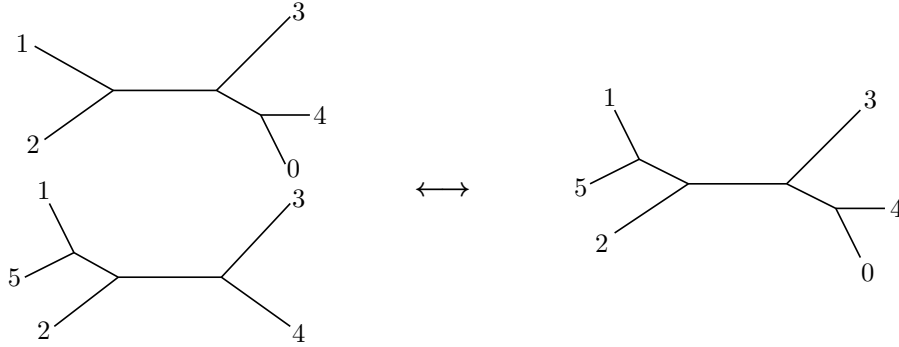

Two 5-marked curves mapped to the same 4-marked curve by ft_0 and ft_5 respectively, and the corresponding 6-marked curve

Except the curves that have a 3-valent vertex which is incident to both, 0 and $(n + 1)$, each $(n + 2)$ -marked rational curve can be obtained that way. An example of such a curve is depicted in the following picture.

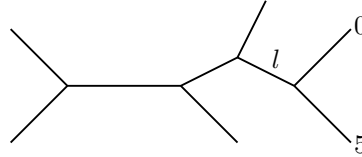

By shrinking the length of the bounded edge adjacent to 0 and $n + 1$ to zero, one obtains a curve C which corresponds to a point in the diagonal $\Delta_{\mathcal{M}_{n+1}} \subsetneq \mathcal{M}_{n+1}^{\text{ft}}$. The modification of $\mathcal{M}_{n+1}^{\text{ft}}$ along the diagonal $\Delta_{\mathcal{M}_{n+1}}$ replaces each point of the diagonal by a set corresponding to the set of curves that are resolutions of the curve C . Thus one can see that this modification makes the above assignment bijective.

4.5. Tropical fibre products II

In this section we extend our fibre product to some morphisms with non-smooth domains. Our main application is to pull back families of curves along arbitrary morphisms.

Definition 4.5.1. Let $Y = \mathbb{B}(M)/L$ be a matroid variety modulo lineality space. Let h_{Δ} be a piecewise polynomial on $Y \times Y$ that cuts out the diagonal Δ_Y (cf. remark 3.8.2). Let $f : X \rightarrow Y$ and $f' : X' \rightarrow Y$ be morphisms of tropical varieties in vector spaces. Assume that f' is locally surjective and that X is locally irreducible and connected in codimension one. Then we define the tropical fibre product

$$X \times_Y X' := (f \times f')^* h_{\Delta} \cdot (X \times X') \in Z_{\dim X + \dim X' - \dim Y}(X \times X').$$

We also define $\pi_X : X \times_Y X' \rightarrow X$ and $\pi_{X'} : X \times_Y X' \rightarrow X'$ to be the projections to the respective factor.

Remark 4.5.2. A priori we do not know that $X \times_Y X'$ is independent of the choice of h_{Δ} and that its support is contained in the set-theoretic fibre product. We will prove these statements in remark 4.5.5 and theorem 4.5.6.

Remark 4.5.3. If all occurring varieties are smooth, then the fibre product of definition 4.5.1 agrees with the fibre product of definition 4.2.6.

Proposition 4.5.4. *With the notations and assumptions of definition 4.5.1, we have*

$$\pi_X^*(p) = \{p\} \times f'^*(f(p)),$$

for each point p in X .

PROOF. Let $\lambda \in \mathbb{Z}_{>0}$ such that there is a (uniquely defined) cocycle $h \in C^{\dim X}(X)$ such that $h \cdot X = \lambda \cdot p$ (cf. remark 3.8.11). By remark 3.8.14 we have

$$\pi_X^*(p) = \frac{1}{\lambda} \pi_X^* h \cdot (f \times f')^* h_\Delta \cdot X \times X' = (f \times f')^* h_\Delta \cdot \{p\} \times X'.$$

Defining the isomorphisms

$$a : X' \rightarrow \{p\} \times X', \quad x' \mapsto (p, x'), \quad b : Y \rightarrow \{f(p)\} \times Y, \quad y \mapsto (f(p), y),$$

we see that this agrees with

$$\begin{aligned} (f \times f')^* h_\Delta \cdot a_* X' &= a_*(a^*(f \times f')^* h_\Delta \cdot X') \\ &= a_*((b \circ f')^* h_\Delta \cdot X') \\ &= \{p\} \times ((b \circ f')^* h_\Delta \cdot X'). \end{aligned}$$

As $\{f(p)\} \times Y$ is a smooth variety and $h_\Delta \cdot (\{f(p)\} \times Y) = \{(f(p), f(p))\}$ by corollary 3.4.8(4) and remark 3.4.12, we can conclude from construction 3.8.12 that

$$\begin{aligned} (b \circ f')^* h_\Delta \cdot X' &= (b \circ f')^* \{(f(p), f(p))\} \\ &= f'^* b^* \{(f(p), f(p))\} \\ &= f'^*(f(p)), \end{aligned}$$

which proves the claim. \square

Remark 4.5.5. We have seen in the previous proposition that fibres along π_X do not depend on the choice of piecewise polynomial h_Δ in definition 4.5.1. We use this to prove that $X \times_Y X'$ is also independent of the choice of h_Δ : Let p be a point in the relative interior of a maximal cell σ of a polyhedral structure of $X \times_Y X'$. As in the proof of proposition 4.2.13 we see that

$$(\pi_X^p)^*(0) = \frac{1}{\lambda} \omega_{X \times_Y X'}(\sigma) \cdot (\pi_X^p)^* \varphi_1 \cdots (\pi_X^p)^* \varphi_{\dim X} \cdot \mathbb{R}^n,$$

where the φ_i are rational functions on $\text{Star}_X(\pi_X(p))$ that cut out $\lambda \cdot \{0\}$ (for some positive integer λ) and $n = \dim X \times_Y X'$. Since $(\pi_X^p)^*(0)$ is not the zero cycle the above equality determines the weight of σ in $X \times_Y X'$. Hence $X \times_Y X'$ is independent of the choice of h_Δ .

Theorem 4.5.6. *Let Y be a smooth tropical variety in a vector space. If $f : X \rightarrow Y$ and $f' : X' \rightarrow Y$ are morphisms of tropical varieties in vector spaces, f' is locally surjective and X is locally irreducible and connected in codimension one, then there is a tropical variety $X \times_Y X'$ such that*

$$|X \times_Y X'| = \{(x, x') \in X \times X' : f(x) = f'(x')\}.$$

In particular, $X \times_Y X'$ satisfies the universal property of fibre products. Furthermore, the projection morphism $\pi_X : X \times_Y X' \rightarrow X$ is locally surjective and its fibres are $\pi_X^(p) = \{p\} \times f'^*(f(p))$.*

PROOF. Let us first assume that $Y = B(M)/L$ is a matroid variety modulo lineality space. Then the cycle $X \times_Y X'$ of definition 4.5.1 satisfies the equation on the support by proposition 4.5.4 and lemma 4.2.4. The positivity of the weights and the local surjectivity of π_X can be deduced in an analogous way as propositions 4.2.13 and 4.2.15.

Now let Y be an arbitrary smooth variety. We glue together the local fibre products to a cycle $X \times_Y X'$ whose support is $\{(x, x') \in X \times X' : f(x) = f'(x')\}$. That means that the cycle $X \times_Y X'$ is given around a point (p, p') with $f(p) = f'(p')$ by

$$\text{Star}_{X \times_Y X'}(p, p') := \text{Star}_X(p) \times_{\text{Star}_Y(f(p))} \text{Star}_{X'}(p'),$$

where the morphisms used for the fibre products are just the local morphisms f^p and $(f')^{p'}$ between the respective stars. Thereby it is crucial that the local fibre products are independent of the choice of piecewise polynomials representing the diagonal because this independence ensures that the weights of the local pieces agree on their overlaps. It is clear that $X \times_Y X'$ inherits the properties listed in the theorem from its local blocks. \square

Remark 4.5.7. Let us stress again that $X \times_Y X'$ is not uniquely characterised by the “tropical universal property”.

We apply the theorem to pull back arbitrary families of curves in the same way as we did for the special case of the forgetful map in the previous section. Note that we need the more general fibre product as the domain of a family might not be smooth.

Corollary 4.5.8. *Let $g : T \rightarrow B$ be a family of n -marked curves and let $f : B' \rightarrow B$ be a morphism of smooth varieties. Then $\pi_{B'} : B' \times_B T \rightarrow B'$ together with the inherited marking $x \mapsto (x, s_i^\theta(f(x)))$ is a family of n -marked curves over B' .*

Bibliography

- [All12] Lars Allermann, *Tropical intersection products on smooth varieties*, J. Eur. Math. Soc. **14** (2012), no. 1, 107–126, available at arxiv:0904.2693v2.
- [All] Lars Allermann, *Chern classes of tropical vector bundles*, to appear in Ark. Mat., available at arxiv:0911.2909v1.
- [All10] Lars Allermann, *Tropical intersection theory*, PhD thesis, Technische Universität Kaiserslautern, 2010, <http://kluedo.ub.uni-kl.de/volltexte/2010/2469>.
- [All2] Lars Allermann, *TropicalSurfaces: Draw tropical surfaces in 3-space*, available at <http://www.mathematik.uni-kl.de/allermann/software.html>.
- [AK06] Federico Ardila and Caroline J. Klivans, *The Bergman complex of a matroid and phylogenetic trees*, J. Combin. Theory Ser. B **96** (2006), no. 1, 38–49, available at arxiv:math/0311370v2.
- [AR10] Lars Allermann and Johannes Rau, *First steps in tropical intersection theory*, Math. Z. **264** (2010), no. 3, 633–670, available at arxiv:0709.3705v3.
- [AR] Lars Allermann and Johannes Rau, *Tropical rational equivalence on \mathbb{R}^r* , available at arxiv:0811.2860v2.
- [Bri96] Michel Brion, *Piecewise polynomial functions, convex polytopes and enumerative geometry*, Parameter Spaces, Banach Center Publ. **36** (1996), 25–44.
- [BBM] Benoît Bertrand, Erwan Brugallé, and Grigory Mikhalkin, *Genus 0 characteristic numbers of tropical projective plane*, available at arxiv:1105.2004.
- [BLdM12] Erwan Brugallé and Lucía López de Medrano, *Inflection points of real and tropical plane curves*, J. Singul. **4** (2012), 74–103, available at arxiv:1102.2478v4.
- [BS] Erwan Brugallé and Kristin M. Shaw, *Obstructions to approximating tropical curves in surfaces via intersection theory*, available at arxiv:1110.0533.
- [CDPR12] Filip Cools, Jan Draisma, Sam Payne, and Elina Robeva, *A tropical proof of the Brill-Noether Theorem*, Adv. Math. **230** (2012), 759–776, available at arxiv:1001.2774v3.
- [Dra08] Jan Draisma, *A tropical approach to secant dimensions*, J. Pure Appl. Algebra **212** (2008), no. 2, 349–363, available at arxiv:math/0605345v3.
- [Est] Alexander Esterov, *Tropical varieties with polynomial weights and corner loci of piecewise polynomials*, available at arxiv:1012.5800v3.
- [EKL06] Manfred Einsiedler, Mikhail Kapranov, and Douglas Lind, *Non-archimedean amoebas and tropical varieties*, J. Reine Angew. Math. **601** (2006), 139–157, available at arxiv:math/0408311v2.
- [Fin] Alex Fink, *Tropical cycles and Chow polytopes*, available at arxiv:1001.4784.
- [Fra09] Georges François, *Exceptional curves on tropical hyperplanes*, Diploma thesis, Technische Universität Kaiserslautern, 2009.
- [Fra] Georges François, *Cocycles on tropical varieties via piecewise polynomials*, to appear in Proc. Amer. Math. Soc., available at arxiv:1102.4783v2. <http://dx.doi.org/10.1090/S0002-9939-2012-11359-0>.
- [Ful93] William Fulton, *Introduction to toric varieties*, Princeton University Press, Princeton, 1993.
- [Ful98] William Fulton, *Intersection theory*, second edition, Ergebnisse der Mathematik und ihrer Grenzgebiete, 3. Folge, Springer Verlag, 1998.
- [FH] Georges François and Simon Hampe, *Universal families of rational tropical curves*, to appear in Canad. J. Math., available at arxiv:1105.1674v3. <http://dx.doi.org/10.4153/CJM-2011-097-0>.
- [FMSS95] William Fulton, Robert MacPherson, Frank Sottile, and Bernd Sturmfels, *Intersection theory on spherical varieties*, J. Algebraic Geom. **4** (1995), 181–193.
- [FR] Georges François and Johannes Rau, *The diagonal of tropical matroid varieties and cycle intersections*, to appear in Collect. Math., available at arxiv:1012.3260v1. <http://dx.doi.org/10.1007/s13348-012-0072-1>.
- [FS97] William Fulton and Bernd Sturmfels, *Intersection theory on toric varieties*, Topology **36** (1997), no. 2, 335–353, available at arxiv:alg-geom/9403002v1.
- [FS05] Eva Maria Feichtner and Bernd Sturmfels, *Matroid polytopes, nested sets and Bergman fans*, Port. Math. (N.S.) **62** (2005), no. 4, 437–468, available at arxiv:math/0411260.
- [GKM09] Andreas Gathmann, Michael Kerber, and Hannah Markwig, *Tropical fans and the moduli spaces of tropical curves*, Compos. Math. **145** (2009), no. 1, 173–195, available at arxiv:0708.2268.

- [GM07a] Andreas Gathmann and Hannah Markwig, *The numbers of tropical plane curves through points in general position*, J. Reine Angew. Math. **602** (2007), 155–177, available at arxiv:math/0504390v2.
- [GM07b] Andreas Gathmann and Hannah Markwig, *The Caporaso-Harris formula and plane relative Gromov-Witten invariants in tropical geometry*, Math. Ann. **338** (2007), 845–868, available at arxiv:math/0504392v3.
- [GMS] Andreas Gathmann, Hannah Markwig, and Franziska Schroeter, *Broccoli curves and the tropical invariance of Welschinger numbers*, available at arxiv:1104.3118.
- [GS] Andreas Gathmann and Franziska Schroeter, *Irreducible cycles and points in special position in moduli spaces for tropical curves*, available at arxiv:1104.3307v1.
- [Ham10] Simon Hampe, *Universal families for rational tropical curves*, Diploma thesis, Technische Universität Kaiserslautern, 2010.
- [Ham] Simon Hampe, *Algorithmic tropical intersection theory (A-Tint), Polymake extension for tropical intersection theory*, available at <https://bitbucket.org/hampe/atint>.
- [IKS09] Ilia Itenberg, Viatcheslav Kharlamov, and Eugenio Shustin, *A Caporaso-Harris type formula for Welschinger invariants of real toric Del Pezzo surfaces*, Comment. Math. Helv. **84** (2009), 87–126, available at arxiv:math.AG/0608549.
- [IKS] Ilia Itenberg, Viatcheslav Kharlamov, and Eugenio Shustin, *Welschinger invariants of small non-toric Del Pezzo surfaces*, to appear in J. Eur. Math. Soc., available at arxiv:1002.1399.
- [JMM08] Anders Nedergaard Jensen, Hannah Markwig, and Thomas Markwig, *An algorithm for lifting points in a tropical variety*, Collect. Math. **59** (2008), no. 2, 129–165, available at arxiv:0705.2441.
- [Kat09] Eric Katz, *A tropical toolkit*, Expo. Math. **27** (2009), 1–36, available at arxiv:math/0610878v3.
- [Kat12] Eric Katz, *Tropical intersection theory from toric varieties*, Collect. Math. **63** (2012), no. 1, 29–44, available at arxiv:0907.2488v1.
- [KM09] Michael Kerber and Hannah Markwig, *Intersecting Psi-classes on tropical $\mathcal{M}_{0,n}$* , Int. Math. Res. Not. **2009** (2009), no. 2, 221–240, available at arxiv:0709.3953v2.
- [KP08] Eric Katz and Sam Payne, *Piecewise polynomials, Minkowski weights, and localization on toric varieties*, Algebra Number Theory **2** (2008), no. 2, 135–155, available at arxiv:math/0703672v2.
- [KP11] Eric Katz and Sam Payne, *Realization spaces for tropical fans*, Combinatorial aspects of commutative algebra and algebraic geometry, Abel Symp. **6** (2011), 73–88, available at arxiv:0909.4582v2.
- [KV07] Joachim Kock and Israel Vainsencher, *An Invitation to Quantum Cohomology*, Progress in Mathematics 249, Birkhäuser Boston, 2007.
- [Mey10] Henning Meyer, *Intersection theory on tropical toric varieties and compactifications of tropical parameter spaces*, PhD thesis, Technische Universität Kaiserslautern, 2010, <https://kluedo.uni-kl.de/frontdoor/index/index/docId/2323>.
- [Mik05] Grigory Mikhalkin, *Enumerative tropical geometry in \mathbb{R}^2* , J. Amer. Math. Soc. **18** (2005), 313–377, available at arxiv:math/0312530v4.
- [Mik06] Grigory Mikhalkin, *Tropical geometry and its applications*, Proceedings of the International Congress of Mathematicians. Vol. II, Eur. Math. Soc., Zürich, 2006, pp. 827–852, available at arxiv:math/0601041.
- [Mik07] Grigory Mikhalkin, *Moduli spaces of rational tropical curves*, Proceedings of the 13th Gökova geometry-topology conference, Cambridge, MA, International Press, 2007, pp. 39–51, available at arxiv:0704.0839v1.
- [MS] Diane Maclagan and Bernd Sturmfels, *Introduction to tropical geometry*, in preparation, available at <http://www.warwick.ac.uk/staff/D.Maclagan/papers/TropicalBook.pdf>.
- [Oxl92] James G. Oxley, *Matroid theory*, Oxford University Press, Oxford, 1992.
- [OP] Brian Osserman and Sam Payne, *Lifting tropical intersections*, available at arxiv:1007.1314v2.
- [Pay06] Sam Payne, *Equivariant Chow cohomology of toric varieties*, Math. Res. Lett. **13** (2006), no. 1, 29–41, available at arxiv:math/0506376v2.
- [Pay09] Sam Payne, *Fibers of tropicalization*, Math. Z. **262** (2009), 301–311, available at arxiv:0705.1732v2.
- [Pay] Sam Payne, *Correction to “Fibers of tropicalization”*, available at arxiv:1204.1837.
- [Rau09] Johannes Rau, *Tropical intersection theory and gravitational descendants*, PhD thesis, Technische Universität Kaiserslautern, 2009, <http://kluedo.uni-kl.de/volltexte/2009/2370>.
- [Rin] Felipe Rincón, *Computing tropical linear spaces*, to appear in J. Symbolic Comput., available at arxiv:1109.4130v2.
- [RGST05] Jürgen Richter-Gebert, Bernd Sturmfels, and Thorsten Theobald, *First steps in tropical geometry*, Idempotent Mathematics and Mathematical Physics, Proceedings Vienna 2003, (editors G.L. Litvinov and V.P. Maslov), AMS, Contemp. Math. **377** (2005), 289–317, available at arxiv:math/0306366v2.
- [Sha] Kristin M. Shaw, *A tropical intersection product in matroidal fans*, available at arxiv:1010.3967.
- [Spe05] David E. Speyer, *Tropical Geometry*, PhD thesis, University of California, Berkeley, 2005, <http://www-personal.umich.edu/~speyer/>.
- [Spe08] David E. Speyer, *Tropical linear spaces*, SIAM J. Discrete Math. **22** (2008), no. 4, 1527–1558, available at arxiv:math/0410455.

- [Stu02] Bernd Sturmfels, *Solving systems of polynomial equations*, CBMS Regional Conference Series in Mathematics, vol. 97, Published for the Conference Board of the Mathematical Sciences, Washington, DC, 2002.
- [SS04] David E. Speyer and Bernd Sturmfels, *The tropical Grassmannian*, Adv. Geom. **4** (2004), 389–411, available at arxiv:math/0304218v3.
- [SS] Mendy Shoval and Eugenio Shustin, *Counting curves of any genus on \mathbb{P}_7^2* , available at arxiv:1108.3089v3.
- [ST08] Bernd Sturmfels and Jenia Tevelev, *Elimination theory for tropical varieties*, Math. Res. Lett. **15** (2008), no. 3, 543–562, available at arxiv:0704.3471v1.
- [Whi86] Neil White, *Theory of Matroids*, Encyclopedia Math. Appl., vol. 26, Cambridge University Press, London, 1986.

Wissenschaftlicher Werdegang

2004–2009	Studium der Mathematik an der TU Kaiserslautern
2007/08	Auslandsjahr an der University of Warwick, England
06/2009	Diplom in Mathematik, TU Kaiserslautern
seit 07/2009	Doktorand bei Prof. Dr. Andreas Gathmann, TU Kaiserslautern

Curriculum Vitae

2004–2009	Studies of Mathematics at the TU Kaiserslautern
2007/08	Exchange at the University of Warwick, England
06/2009	Diploma in Mathematics, TU Kaiserslautern
since 07/2009	Doctoral student with Prof. Dr. Andreas Gathmann, TU Kaiserslautern