

Moduli spaces of rational tropical stable maps into smooth tropical varieties

Dennis Ochse

Vom Fachbereich Mathematik der
Technischen Universität Kaiserslautern
zur Verleihung des akademischen Grades
Doktor der Naturwissenschaften
(Doctor rerum naturalium, Dr. rer. nat.)
genehmigte Dissertation

Datum der Disputation: 24.05.2013

Erster Gutachter: Professor Andreas Gathmann
Zweiter Gutachter: Assistant Professor Eric Katz

D 386

Contents

Preface	5
Introduction	5
Results	8
Financial Support	9
Danksagung	9
Chapter 1. Moduli spaces of tropical stable maps	11
1.1. Introduction to tropical geometry	11
1.2. Introduction to tropical moduli spaces	20
1.3. A brief review of tropical intersection theory	32
1.4. Pulling back the diagonal of L_r^q	36
1.5. Gluing moduli spaces	43
1.6. Examples of gluing	60
Chapter 2. Relations between algebraic and tropical moduli spaces	67
2.1. Notions from toric geometry	67
2.2. Tropical and algebraic moduli spaces	73
2.3. The virtual fundamental class	95
2.4. Boundary behaviour of $W_{\Delta, Y}$	99
Chapter 3. Tropical moduli spaces of covers and of lines in surfaces	113
3.1. Constructing local tropical moduli spaces	113
3.2. The case of curves	117
3.3. Lines in smooth tropical surfaces, the tropical cubic	126
3.4. Examples for computing weights $\deg [W_{\Delta, Y}]^{vir}$	129
Bibliography	133

Preface

Introduction

Enumerative geometry is concerned with counting curves in algebraic varieties that satisfy certain conditions. Even though enumerative problems are easy to formulate, it is in general very hard to solve them. The most important tools of modern enumerative geometry are moduli spaces $\overline{M}_{g,n}(X, \beta)$ of degree β stable maps from n -marked genus g curves into a smooth projective variety X . Intersection theory on these moduli spaces has been used to solve several difficult enumerative problems, such as determining the number of rational curves of degree d in a quintic threefold ([Kon]) or the number of rational plane degree d curves through $3d - 1$ points in general position ([KM94]).

Tropical geometry is a branch of algebraic geometry, in which the so-called tropicalisation transforms a scheme into a weighted, balanced polyhedral complex. These complexes, the so-called tropical varieties, are combinatorial objects, which can be studied with non-algebraic methods and can reveal new insights about algebraic geometry. Tropical geometry has proven to be useful in enumerative geometry in several circumstances. For example, Mikhalkin proved in his famous "Correspondence Theorem" that the number of plane curves of given genus and degree through some given points equals the number of certain plane tropical curves through the same number of points, [Mik05]. Another example is the computation of Welschinger invariants in real enumerative geometry by Shustin [Shu06]. From these results, a purely tropical enumerative geometry evolved, cf. [Mik06], [GM07], [GKM09].

Following the ideas from algebraic geometry, tropical moduli spaces $\mathcal{M}_{0,n}(\mathbb{R}^m, \Delta)$ of degree Δ tropical stable maps from rational tropical curves with n marked "points" into \mathbb{R}^m have been introduced in [Mik06] or [GKM09]. So far, there are no moduli spaces for rational stable maps into tropical varieties different from \mathbb{R}^m . Therefore very interesting algebraic enumerative problems, like counting lines in a cubic surface or rational curves in a quintic threefold, are inaccessible to the tropical theory. The original aim of this thesis was to construct moduli spaces $\mathcal{M}_{0,n}(\mathcal{X}, \Delta)$ of degree Δ rational tropical stable maps into a smooth tropical subvariety $\mathcal{X} \subset \mathbb{R}^m$. This could only be achieved partially, as we will explain below.

In the algebraic theory, it is possible to construct $\overline{M}_{0,n}(X, \beta)$ for a subvariety $X \subset \mathbb{P}^m$ essentially as a union of connected components of the zero locus of some global sections of a certain vector bundle on $\overline{M}_{0,n}(\mathbb{P}^m, d)$, cf. [FP97]. Unfortunately, this approach does not carry over to the tropical world for lack of a suitable tropical vector bundle.

Another approach would be to tropicalise the algebraic moduli space for a suitable choice of coordinates. This has the major drawback that the algebraic space in general has several components of different, not expected dimensions. It is therefore necessary to use the virtual fundamental class instead of the usual one if one intends to do intersection theory. If we tropicalise the irreducible components of the algebraic space separately, the tropicalisations would then also be of the wrong dimension and we would have to find a suitable virtual fundamental class of the tropicalisation. On the other hand, the virtual fundamental class of the algebraic space, which has the correct dimension, cannot be tropicalised.

The approach of this thesis is to directly construct a virtual class $\mathcal{M}_{0,n}(\mathcal{X}, \Delta)$, i.e. a tropical variety of the correct dimension, consisting of curves satisfying easy local combinatorial conditions. The price we have to pay is that it is extremely difficult to find the right weights on this space and to show that they actually make $\mathcal{M}_{0,n}(\mathcal{X}, \Delta)$ balanced. This has been carried out successfully in the case where \mathcal{X} is a smooth curve and in the case of tropical lines, when $\mathcal{X} \subset \mathbb{R}^3$ is a smooth surface, in this thesis.

The content of this thesis can be summarised as follows.

Chapter 1: The first four sections of Chapter 1 provide the basic notions and technical tools which are needed in Section 1.5, which is the central part of the first chapter. In Section 1.6 examples of our constructions are given. The main issues of Chapter 1 are the following.

We want to reduce the construction of $\mathcal{M}_{0,n}(\mathcal{X}, \Delta)$ for a general smooth \mathcal{X} (which is a hypersurface or curve) to the case where \mathcal{X} is a fan. The idea is the following: For a tropical stable map $h : \Gamma \rightarrow \mathcal{X}$, where Γ is a metric graph of genus zero, of a given combinatorial type we want to "cut" the abstract curve Γ along all of its edges into local pieces Γ_v , which are then in bijection with the vertices v of Γ . We want to do this in a way such that h maps Γ_v into a local part of \mathcal{X} which looks like a fan. Knowing something about stable maps to fans can yield information about stable maps into \mathcal{X} . In this summary it will be outlined how this can be done.

We would like to consider the local pieces Γ_v together with the restriction of h as an element of some tropical moduli space \mathcal{M}_v . As Γ_v has bounded leaves, we cannot obtain \mathcal{M}_v as a subspace of the kind of moduli spaces from [GKM09], because they only allow unbounded leaves.

Therefore we extend the moduli spaces $\mathcal{M}_{0,n}(\mathbb{R}^m, \Delta)$ to moduli spaces of stable maps where some of the leaves are bounded. We also construct evaluation morphisms which assign to a stable map the image in \mathbb{R}^m of the endpoint of a bounded leaf. Additionally we construct morphisms which forget the lengths of the bounded leaves letting them become unbounded. This is done in Section 1.2. As the lengths of the bounded leaves are always positive, those moduli spaces will "end" where the length goes to zero. This is why we need to define *partially open* tropical varieties in Section 1.1. Furthermore, we also want to deal with stable maps without marked points, i.e. elements of $\mathcal{M}_{0,0}(\mathbb{R}^m, \Delta)$. This is needed, for example when we consider lines in a tropical cubic, cf. Section 3.3, but also to construct \mathcal{M}_v , as some of the local curve pieces from above might not have marked points. However, dealing with $\mathcal{M}_{0,0}(\mathbb{R}^m, \Delta)$ is not possible with the approach from [GKM09], as $n \geq 1$ is assumed there. Thus we introduce new coordinates on $\mathcal{M}_{0,n}(\mathbb{R}^m, \Delta)$, using the barycentres of the images of the curves, cf. Definition 1.2.15.

Let us return to the local curve pieces. We will assume that every vertex v is *good*, cf. Definition 1.5.12. One part of the condition of being good is, that we assume we already constructed a moduli space \mathcal{M}_v of the correct expected dimension and equipped with suitable weights, cf. Definition 1.5.9, which will be fixed in the last chapter. Furthermore, \mathcal{M}_v has to satisfy an intrinsic compatibility condition, which we will explain in the paragraph after next. We now want to "glue" the local curve pieces back to the original curve using tropical intersection theory. For an edge of Γ we obtain two bounded leaves from cutting. So we can take the product of the evaluations at these two leaves, which then maps into \mathcal{X}^2 . We impose the condition that the two leaves fit together by pulling back the diagonal via the product of evaluations to the product $\prod_v \mathcal{M}_v$.

Unfortunately, tropical intersection theory does not provide a well-defined pull back for arbitrary cycles, even if they are a product of Cartier divisors. To pull back the diagonal in a way that satisfies all the properties one would expect, we have to do cumbersome constructions and computations in Section 1.4.

The tropical variety that we obtain after pulling back the diagonal for each edge still carries the information of where we cut the edges. We want to get rid of this superfluous information by dividing out a lineality space. To do this, we extend the notion of a lineality space to partially open tropical varieties in Section 1.1. After getting rid of the cutting points by taking the quotient, we obtain a tropical variety in $\mathcal{M}_{0,n}(\mathbb{R}^m, \Delta)$, which we will call the gluing cycle of the stable map (Γ, h) , cf. Construction 1.5.13. The gluing cycle will only depend on the combinatorial type of the original stable map. If all vertices of all combinatorial types are good, it turns out that all the gluing cycles fit together to the tropical variety $\mathcal{M}_{0,n}(\mathcal{X}, \Delta)$. This is Theorem 1.5.21. To prove this, we need the intrinsic compatibility of \mathcal{M}_v , which just means that the moduli space \mathcal{M}_v can itself be obtained from gluing cycles. Furthermore, the stable maps in $\mathcal{M}_{0,n}(\mathcal{X}, \Delta)$ satisfy easy combinatorial conditions, cf. Definition 1.5.10, and the variety $\mathcal{M}_{0,n}(\mathcal{X}, \Delta)$ will be of the correct expected dimension.

The more difficult, and mainly unsolved, problem is to show that the vertices v actually are good. At the end of Section 1.5 we will reduce this problem to showing that $\mathcal{M}_{0,n}(\mathcal{X}, \Delta)$ is a moduli space obtained from gluing cycles, if its expected (and then by construction also its actual) dimension is one and \mathcal{X} is a fan.

Chapter 2: Even in this simplified situation from above, there seems to be no feasible purely combinatorial description of the tropical stable maps into \mathcal{X} that satisfy our local combinatorial conditions. Of course it is then hard to show that $\mathcal{M}_{0,n}(\mathcal{X}, \Delta)$ is balanced, as we do not know its maximal cells. The idea of the second chapter is to translate both problems into intersection theory on a suitable algebraic moduli space.

First we review certain aspects of toric geometry in Section 2.1. Our main objective is toric intersection theory, but we also explain a description of morphisms into smooth projective toric varieties $X(\Sigma)$ given by Cox. In Section 2.2 we will focus on subvarieties $Y \subset X(\Sigma)$ which tropicalise to a subfan \mathcal{Y} of Σ . We will define a stack $M_{\Delta, Y}$ of all $|\Delta|$ -marked rational stable maps into Y satisfying certain multiplicity conditions to the toric boundary given by Δ at the marked points. Furthermore, we will define the substack $W_{\Delta, Y}$ of $M_{\Delta, Y}$ of curves that are deformations of irreducible curves in $M_{\Delta, Y}$. It turns out that the curves in $M_{\Delta, Y}$ and $W_{\Delta, Y}$ have a tropical meaning. In particular, the curves in $W_{\Delta, Y}$ correspond to combinatorial types of degree Δ stable maps into \mathcal{Y} , cf. Theorem 2.2.18. We will define a boundary of $W_{\Delta, Y}$ and show that we can obtain specific elements in the tropical moduli space from the multiplicities of certain Cartier divisors to this boundary. However, the examples given in Section 2.2 show that the combinatorial types of tropical curves that we obtain this way, do not correspond to those which satisfy the local combinatorial conditions from Chapter 1. Also, the dimension of $W_{\Delta, Y}$ is not always equal to the expected one.

Therefore, we will construct a virtual fundamental class of $W_{\Delta, Y}$ in Section 2.3 in the case of an integral hypersurface Y . This virtual fundamental class has the expected dimension and will be obtained from the stack $W_{\Delta, X(\Sigma)}$ as intersection with the top Chern class of some vector bundle.

As the boundary of $W_{\Delta, Y}$ encodes information about tropical stable maps, we want to study it in Section 2.4. We will mostly restrict to properties of the boundary of $W_{\Delta, X(\Sigma)}$, since this is much easier to understand. It turns out that the boundary can be stratified by combinatorial types of degree Δ tropical stable maps into Σ . We will show that if a combinatorial type satisfies certain conditions, the locus of stable maps in $W_{\Delta, X(\Sigma)}$ corresponding to it has a recursive structure, cf. Proposition 2.4.13. We also describe how the stacks $W_{\Delta, X(\Sigma)}$ behave under refinements of the fan Σ , i.e. blow ups of the toric variety. We can use this to show that one-dimensional combinatorial types define irreducible boundary divisors of $W_{\Delta, X(\Sigma)}$, cf. Corollary 2.4.17. We conclude the second chapter by showing that $W_{\Delta, X(\Sigma)}$ is unibranch around some of these irreducible boundary divisors, which enables us to explicitly determine multiplicities of certain Cartier divisors along those boundary divisors. Those are the multiplicities we need to obtain an element in the tropical moduli space.

Chapter 3: In the last chapter the results from the first two chapters are brought together. If the expected dimension of $\mathcal{M}_{0,n}(\mathcal{Y}, \Delta)$ is one, we use the intersection theoretic results from Chapter 2 to construct a one dimensional tropical fan in $\mathcal{M}_{0,n}(\mathbb{R}^m, \Delta)$ whose elements are stable maps to \mathcal{Y} . This is done in Section 3.1. Unfortunately, it is *not* clear whether this tropical variety obtained from intersection theory can also be obtained from gluing as in Chapter 1 or not. So the problem outlined above has not been solved completely. However, the construction of a tropical fan with algebraic intersection theory seems to be a promising approach, cf. Conjecture 3.1.7. In this conjecture we claim that the correct weights of $\mathcal{M}_{0,n}(\mathcal{X}, \Delta)$ for a smooth hypersurface \mathcal{X} can be obtained from the degrees of virtual fundamental classes of certain $W_{\Delta, \mathcal{Y}}$. To substantiate this claim, we determine a few such degrees of virtual fundamental classes in Section 3.4. This sheds a new light on some of the examples in Section 1.6.

In Section 3.2 we will use our methods to show that if we restrict \mathcal{X} to smooth curves, all vertices are good, cf. Theorem 1.5.21. The results from the first chapter yield a tropical moduli space $\mathcal{M}_{0,n}(\mathcal{X}, \Delta)$ of rational covers of smooth tropical curves. It turns out that the weights on this moduli space can be obtained from multi-point Hurwitz numbers, cf. Definition 3.2.8.

In Section 3.3 we will construct tropical moduli spaces of lines in smooth surfaces in \mathbb{R}^3 , cf. Proposition 3.3.3. In particular, as our spaces have the correct dimension, we obtain a moduli space of lines in a given tropical cubic, which has dimension zero. So even though smooth tropical cubics might contain infinitely many lines, cf. [Vig10], our moduli spaces always contain only a finite number of them. This allows for a virtual count of tropical lines in smooth tropical cubics.

Results

In this thesis we extend the existing constructions of tropical moduli spaces of tropical rational stable maps and relate these tropical moduli spaces to intersection theory on algebraic moduli spaces. The main results are:

- We define a tropical structure on the moduli space of rational tropical stable maps $\mathcal{M}_{0,n}(\mathbb{R}^m, \Delta)$ using the barycentre of the images of the maps. This is done in Section 1.2 and is also possible if $n = 0$ unlike the construction from [GKM09].
- We reduce the task of constructing $\mathcal{M}_{0,n}(\mathcal{X}, \Delta)$ for arbitrary smooth $\mathcal{X} \subset \mathbb{R}^m$ (which is a hypersurface or curve) to the case where \mathcal{X} is a fan and the expected dimension of $\mathcal{M}_{0,n}(\mathcal{X}, \Delta)$ is one. However, we need to make sure that $\mathcal{M}_{0,n}(\mathcal{X}, \Delta)$ has some additional properties in this case. This is the content of Section 1.5.
- We construct tropical moduli spaces $\mathcal{M}_{0,n}(\mathcal{X}, \Delta)$ of tropical covers, i.e. stable maps that have a smooth tropical curve \mathcal{X} as target. This is Corollary 3.2.15. Our methods also provide relations between multi-point Hurwitz numbers, which allow their recursive computation, cf. Remark 3.2.16.
- We construct tropical moduli spaces of lines in smooth surfaces in \mathbb{R}^3 , cf. Proposition 3.3.3. In particular, this includes smooth tropical cubic surfaces, which, even though this is not expected, might contain infinitely many lines, cf. [Vig10]. However, our moduli space will allow a virtual count of lines for every smooth cubic.
- In Theorem 2.2.18 we prove that deformations of irreducible algebraic stable maps into smooth projective toric varieties correspond to combinatorial types of tropical stable maps. In Lemmas 3.1.2 and 3.1.3 we show that these combinatorial types can be recovered from intersection multiplicities on a suitable moduli space of algebraic stable maps.

Financial Support

Financial support was granted by *Lotto Rheinland-Pfalz Stiftung* and *TU Kaiserslautern*. I am grateful to both of them for their support. Furthermore I am grateful to the *MSRI* in Berkeley for financial support and hospitality during the Tropical Semester in 2009, and to *Institut Mittag-Leffler* in Stockholm for hospitality in spring 2011.

Danksagung

Ich danke meinem Betreuer Andreas Gathmann für die hervorragende Betreuung während der Promotion, die gute Arbeitsatmosphäre und die vielen hilfreichen Diskussionen und Anregungen. Außerdem für die gute Reiseleitung in den USA und diverse Kuchen.

Ich danke meinen Eltern Herbert und Petra, die mich immer und insbesondere auch während meines ganzen Studiums unterstützt haben.

Ich danke meinen Freunden und (ehemaligen) Kollegen Lars Allermann, Sarah Brodsky, Jens Demberg, Christian Eder, Georges François, Joke Frels, Andreas Gross, Simon Hampe, Matthias Herold, Tommy Hofmann, Henning Meyer, Johannes Rau, Yue Ren, Irene Tittmann, Carolin Torchiani und Anna Lena Winstel für die angenehme Arbeitsatmosphäre, die vielen Kuchen und auch hilfreiche fachliche Diskussionen.

Ich danke den tropischen Geometern aus Saarbrücken Hannah Markwig, Arne Buchholz und Franziska Schroeter für die gute Zusammenarbeit.

Ich danke meinen Freunden und meiner Familie für die moralische Unterstützung.

Ich danke Kirsten Schmitz fürs immer für mich da sein.

Moduli spaces of tropical stable maps

The first chapter contains most of the tropical geometry part of this thesis. In Section 1.1 we will recall tropicalisation of algebraic varieties and the definition of tropical varieties but in a slightly more general way than usual, as we will allow them to be *partially open*. This enables us to study tropical varieties locally. In Section 1.2 we will describe moduli spaces of rational tropical curves, but with the additional feature of bounded leaves, making the moduli space partially open. Section 1.3 just lists the tools from tropical intersection theory that we will need, except for a well-defined pull back of the diagonal in a smooth tropical fan, which will occupy Section 1.4 and is quite technical. We will bring all this together in Section 1.5, where we will use intersection theory to "glue" a moduli space of rational curves in a smooth tropical variety from suitable "smaller" and easier to understand moduli spaces. We will give several examples for this in the last section, 1.6.

1.1. Introduction to tropical geometry

There are several approaches to tropical geometry. One is to use tropical geometry as a tool in algebraic geometry via the so called "tropicalisation" and another one is to study tropical varieties as purely combinatorial objects. A good reference for the algebro geometric point of view is the book by B. Sturmfels and D. Maclagan [SM13] which is still work in progress but already covers a wide variety of topics that is otherwise scattered in the literature. Good references for an overview of a purely combinatorial approach are the PhD theses of G. François [Fra12] and J. Rau [Rau09]. Most of the already existing definitions in this section and Section 1.3 are taken from these three sources.

Definition 1.1.1 (Fields and tropicalisation). Let \mathfrak{K} be an algebraically closed field. Then the *Mal'cev-Neumann ring of generalised power series* $K = \mathfrak{K}((\mathbb{R}))$ consists of all formal power series $\sum_{\varepsilon} a_{\varepsilon} t^{\varepsilon}$ with coefficients in \mathfrak{K} and $\varepsilon \in \mathbb{R}$ such that $\{\varepsilon \in \mathbb{R} \mid a_{\varepsilon} \neq 0\}$ is well ordered. This is also an algebraically closed field, containing the field $\mathfrak{K}\{\{t\}\}$ of *Puiseux series*, which is the algebraic closure of the field of the Laurent series (cf. Section 2.1 of [SM13]). K (and also $\mathfrak{K}\{\{t\}\}$) has a valuation given by

$$v : K^* \longrightarrow \mathbb{R}, \quad \sum_{\varepsilon} a_{\varepsilon} t^{\varepsilon} \longmapsto \min\{\varepsilon \in \mathbb{R} \mid a_{\varepsilon} \neq 0\}.$$

We also denote the coordinate-wise valuation by v :

$$v : (K^*)^m \longrightarrow \mathbb{R}^m, \quad (x_1, \dots, x_m) \longmapsto (v(x_1), \dots, v(x_m)).$$

For any subvariety of the torus $X \subset (K^*)^m$ we can define the set of all coordinate-wise valuations as the *tropicalisation* of X

$$\text{trop}(X) := \{v(x) \mid x \in X\}.$$

This defines the tropicalisation as a set. Usually the tropicalisation also involves weights, cf. Theorem 1.1.4. For a definition of the weights of the tropicalisation we refer to Chapter 2 of [Spe05] or Definition 3.4.3 of [SM13].

Remark 1.1.2 (Tropicalisation and field extensions). Let $K[x^{\pm}]$ denote the ring of Laurent polynomials in x_1, \dots, x_m with coefficients in K . If $I \subset K[x^{\pm}]$ is an ideal with vanishing locus $Z(I) =: X_K$, the *Fundamental Theorem of Tropical Geometry* (cf. [SM13] Theorem 3.2.5,

or [Dra08] Theorem 4.2) states that $\omega \in \text{trop}(X_K)$ if and only if $\text{in}_\omega(I) \neq K[x^\pm]$. Here $\text{in}_\omega(I)$ is the initial ideal with respect to ω (cf. [SM13], Section 2.4). The second condition can be checked by a Gröbner basis computation. Let now \mathfrak{L} be an algebraically closed extension field of \mathfrak{k} and $L = \mathfrak{L}((\mathbb{R}))$. If I is generated by polynomials with coefficients only in \mathfrak{k} (this is usually called the constant coefficient case), we have $\text{in}_\omega(I) \neq K[x^\pm]$ if and only if $\text{in}_\omega(IL[x^\pm]) \neq L[x^\pm]$. The reason for this is that all Gröbner basis computations take place in the field \mathfrak{k} . We conclude that $\text{trop}(X_K) = \text{trop}(X_L)$, where $X_L := Z(IL[x^\pm]) \subset (L^*)^m$.

To formulate some results about the tropicalisation we should first recall a few definitions concerning polyhedra.

Definition 1.1.3 (Notions from polyhedral geometry). Let Λ be a lattice, i.e. a group which is isomorphic to some \mathbb{Z}^m , and consider the real vector space $V = \Lambda \otimes_{\mathbb{Z}} \mathbb{R}$. Then a subset of the form

$$(1) \quad \sigma = \{x \in V \mid \forall i \in I : f_i(x) \geq c_i \text{ and } \forall j \in J : g_j(x) > d_j\} \subset V$$

for finite index sets I and J with $f_i, g_j \in \Lambda^\vee$ and $c_i, d_j \in \mathbb{R}$ is called a *rational polyhedron* and it is called a *cone* if all $c_i = 0$ and $d_j = 0$. A subset of σ that is obtained by replacing some " \geq " by " $=$ " in (1) is called a *face of σ* , and it is denoted a *facet* if it is a face of codimension one. If τ is a face of σ we write $\sigma \geq \tau$. For a polyhedron σ we define a subvector space $V_\sigma := \langle x - y \mid x, y \in \sigma \rangle_{\mathbb{R}}$. As lattice of V_σ we take $\Lambda_\sigma := \Lambda \cap V_\sigma$. The *relative interior* σ° is the interior of σ inside the affine linear subspace spanned by it, or equivalently σ without all its proper faces. A polyhedron σ is called *partially open* if it is not closed in the affine linear subspace spanned by it.

A finite collection \mathcal{X} of rational polyhedra in V is called *rational polyhedral complex* if for $\sigma \in \mathcal{X}$ all faces of σ lie in \mathcal{X} and for any two $\sigma, \tau \in \mathcal{X}$ the intersection $\sigma \cap \tau$ is a face of σ and of τ , hence also in \mathcal{X} . Furthermore, we require that for all $\sigma, \tau \in \mathcal{X}$ with $\bar{\sigma} \cap \bar{\tau} \neq \emptyset$ we already have $\sigma \cap \tau \neq \emptyset$. The elements of \mathcal{X} are called *cells*. We write $\mathcal{X} \subset V$ to indicate in which vector space the polyhedra live. Note that *all* polyhedra and polyhedral complexes in this thesis will be rational, and we will therefore omit the term "rational" from now on. A polyhedral complex will be called *partially open* if it contains at least one partially open cell and *closed* otherwise. Let $\dim \mathcal{X} := \max\{\dim \sigma \mid \sigma \in \mathcal{X}\}$ and let $\mathcal{X}(k)$ denote the set of all k -dimensional cells of \mathcal{X} . We call a polyhedral complex *pure* if all its inclusion maximal cells are of the same dimension. If \mathcal{X} is pure we denote by $\mathcal{X}^{(k)}$ the set of all cells of codimension k , i.e. of dimension $\dim \mathcal{X} - k$. For a cell $\sigma \in \mathcal{X}$ we define $\mathcal{X}(\sigma) := \bigcup_{\tau \geq \sigma} \tau^\circ$. We define $\text{Star}_{\mathcal{X}}(\sigma)$ as the fan in V/V_σ with lattice Λ/Λ_σ , consisting of cones $\bar{\tau} := \mathbb{R}_{\geq 0}((\tau - P)/V_\sigma)$ for all $\tau \in \mathcal{X}$ with $\tau \geq \sigma$ and some point $P \in \sigma$. The *support* of a polyhedral complex is $|\mathcal{X}|_{\text{poly}} = \bigcup_{\sigma \in \mathcal{X}} \sigma$. We use the index "poly" in order to distinguish this from the support of a weighted polyhedral complex, that is defined later on. A set X is called *polyhedral set* if it is the support of some polyhedral complex \mathcal{X} and we define $\dim X := \dim \mathcal{X}$, which clearly does not depend on the choice of \mathcal{X} with the property $|\mathcal{X}|_{\text{poly}} = X$. For two polyhedral complexes \mathcal{X} and \mathcal{Y} we say that \mathcal{Y} is a *subcomplex* of \mathcal{X} , written $\mathcal{Y} \leq \mathcal{X}$, if $|\mathcal{Y}|_{\text{poly}} \subset |\mathcal{X}|_{\text{poly}}$ and for each $\sigma \in \mathcal{Y}$ we have a cell $\tau \in \mathcal{X}$ such that $\sigma^\circ = \tau^\circ$. Note that a polyhedron σ is a polyhedral set, it is the support of the polyhedral complex $\{\tau \mid \tau \leq \sigma\}$ which we will also denote σ by abuse of notation.

A polyhedral complex \mathcal{X} is called a *fan* if $0 \in \bigcap_{\sigma \in \mathcal{X}} \bar{\sigma}$. We call it an *affine fan* if it is a translation of a fan by a vector in V , which is called an *apex* of the affine fan. For an affine fan \mathcal{X} we want to call the cell $\bigcap_{\sigma \in \mathcal{X}} \sigma$ the *central cell* of \mathcal{X} . The central cell is the unique inclusion minimal cell of the affine fan. Note that if \mathcal{X} is a closed fan, i.e. all $\sigma \in \mathcal{X}$ are closed polyhedra, then all $\sigma \in \mathcal{X}$ must be cones as in the usual definition of a fan from the literature. This can be seen as follows. Let $\sigma = \{x \in V \mid f_i(x) \geq c_i \text{ for } i \in I\} \in \mathcal{X}$. Then for every $i \in I$ replacing the inequality by $f_i(x) = c_i$ defines a face of σ . By definition this face must contain 0, hence $0 = f_i(0) = c_i$.

Let Λ' be another lattice with vector space $V' = \Lambda' \otimes_{\mathbb{Z}} \mathbb{R}$ and let $g : V \rightarrow V'$ be an \mathbb{R} -linear map satisfying $g(\Lambda) \subset \Lambda'$. Then g is called *integer linear*. Any translation $f = g + c$ for $c \in V'$ is called *affine integer linear* and $f_{\text{lin}} := g$ is called the *linear part* of f . For any polyhedral complex $\mathcal{X} \subset V'$ the preimage $f^{-1}\mathcal{X}$ under an integer affine linear map is the polyhedral complex $\{f^{-1}\sigma \mid \sigma \in \mathcal{X}\}$. Note that this again consists of rational cells. Of course the set theoretic preimage of a polyhedral set is again a polyhedral set.

A pair $(\mathcal{X}, \omega_{\mathcal{X}})$ is called *weighted polyhedral complex*, if \mathcal{X} is a pure polyhedral complex and $\omega_{\mathcal{X}} : \mathcal{X}^{(0)} \rightarrow \mathbb{Q}$ is a function. The rational number $\omega_{\mathcal{X}}(\sigma) \in \mathbb{Q}$ is called the *weight* of σ . We usually omit the function $\omega_{\mathcal{X}}$ and denote a weighted polyhedral complex just by the complex \mathcal{X} . Note that in the literature one usually restricts to weights from \mathbb{Z} , but we will need rational weights on our moduli spaces $\mathcal{M}_{0,n}(\mathcal{X}, \Delta)$ in order to make them balanced in a "nice" way. For a weighted polyhedral complex \mathcal{X} we define the *support* $|\mathcal{X}|$ as the union over all maximal cells with non-zero weight. If τ is a facet of σ then we can define $u_{\sigma/\tau} \in \Lambda_{\sigma}/\Lambda_{\tau}$ to be the primitive integral vector lying in the same half line of V_{σ}/V_{τ} as σ . We call a weighted polyhedral complex *balanced* if for all its facets $\tau \in \mathcal{X}^{(1)}$

$$(2) \quad \sum_{\substack{\sigma \in \mathcal{X}^{(0)} \\ \sigma \geq \tau}} \omega_{\mathcal{X}}(\sigma) u_{\sigma/\tau} = 0.$$

With these notions from polyhedral geometry we can state the following very important theorem:

Theorem 1.1.4. *If $X \subset (K^*)^m$ is an irreducible variety, then $\text{trop}(X)$ is the support of a closed polyhedral complex of pure dimension $\dim X$. The maximal cells of this polyhedral complex also come with intrinsic positive integer weights (depending on the ideal defining X , i.e. the scheme structure of X) turning $\text{trop}(X)$ into a weighted and balanced polyhedral complex.*

PROOF. This can be found for example in [Spe05] Section 2.2 (polyhedral structure), Proposition 2.4.5 (pure dimensionality) and Proposition 2.5.1 (balance). \square

This theorem justifies the following definition of tropical subvarieties of some real vector space:

Definition 1.1.5 (Tropical varieties). A *tropical polyhedral complex* is a weighted polyhedral complex $\mathcal{X} \subset V = \Lambda \otimes_{\mathbb{Z}} \mathbb{R}$ that is balanced. A *refinement* of \mathcal{X} is another tropical polyhedral complex $\mathcal{X}' \subset V$ with $|\mathcal{X}'| = |\mathcal{X}|$ such that for all $\sigma' \in \mathcal{X}'$ with $\sigma' \subset \sigma$ there is a $\sigma \in \mathcal{X}$ with $\sigma' \subset \sigma$. For maximal cones we require $\omega_{\mathcal{X}'}(\sigma') = \omega_{\mathcal{X}}(\sigma)$ in this case. Note that this imposes no condition on the cells of weight zero. Two tropical polyhedral complexes that have a common refinement are called *equivalent*. One can check that this in fact defines an equivalence relation. We define a *tropical cycle* or *tropical variety* to be an equivalence class $[\mathcal{X}]$ of tropical polyhedral complexes. Note that in the literature the term tropical variety is usually reserved for a tropical cycle with only positive weights, but the space $\mathcal{M}_{0,n}(\mathcal{X}, \Delta)$ we are interested in will in general also have negative weights. A representative \mathcal{X} of a tropical variety $[\mathcal{X}]$ is also called a *polyhedral structure* on $[\mathcal{X}]$. We will usually just write \mathcal{X} for the tropical variety $[\mathcal{X}]$. If we have two tropical polyhedral complexes \mathcal{X} and \mathcal{Y} we usually write $\mathcal{X} = \mathcal{Y}$ if they are representatives of the same tropical variety. Of course all representatives of a tropical variety \mathcal{X} live in the same vector space V and we will write $\mathcal{X} \subset V$ for this.

For tropical polyhedral complexes \mathcal{X} the support $|\mathcal{X}|$ is obviously well-defined on equivalence classes. Therefore we can define the *support* of a tropical variety as the support of any of its polyhedral structures. The *dimension* of \mathcal{X} is then the dimension of $|\mathcal{X}|$. Note that this is not well-defined for \emptyset and we want to consider \emptyset to have any dimension, because this will be the zero element in the group of tropical cycles of dimension k , cf. Definition 1.3.1. A tropical variety is called *closed* if $|\mathcal{X}|$ is closed in V and *partially open* otherwise. Note

that each representative of a partially open tropical variety is a partially open polyhedral complex. A tropical variety is an (*affine*) *tropical fan* if it admits a polyhedral structure which is an (*affine*) fan. In this case the central cell of such a fan structure is called a *central cell* of \mathcal{X} . Another tropical variety \mathcal{Y} is called a *subvariety* of \mathcal{X} , if $|\mathcal{Y}| \subset |\mathcal{X}|$ is closed. We write $\mathcal{Y} \subset \mathcal{X}$ for this. A tropical variety \mathcal{X} is called *reducible* if there exists a subvariety $\mathcal{Y} \subset \mathcal{X}$ with $\dim \mathcal{Y} = \dim \mathcal{X}$ but $|\mathcal{X}| \neq |\mathcal{Y}|$. It is called *irreducible* if it is not reducible.

Although tropicalisations of algebraic varieties are always closed we will need the slightly more general notion of partially open tropical varieties as a technical tool for our construction of $\mathcal{M}_{0,n}(\mathcal{X}, \Delta)$. Also note that not every closed tropical variety is actually a tropicalisation of a subvariety in $(K^*)^m$. A tropical variety $\mathcal{X} \subset \mathbb{R}^m$ is called *realisable* if there exists an ideal $I \subset K[x^\pm]$ with $Z(I) = X \subset (K^*)^m$ and $\text{trop}(X) = |\mathcal{X}|$ such that the weights on \mathcal{X} coincide with those defined by I which were already mentioned in Theorem 1.1.4. To determine whether a tropical variety is realisable or not is in general a very hard problem which is known as *tropical inverse problem*, *lifting problem* or *realisability problem* in the literature. It is true that tropical hypersurfaces and rational tropical curves in \mathbb{R}^m (with positive integer weights) are always realisable. The case of rational curves is treated in Theorem 5.0.4 of [Spe05] and the case of hypersurfaces can be found in Theorem 3.15 of [Mik05].

Example 1.1.6 (The tropical linear spaces L_k^n). A basic but important example of tropical varieties are the tropical linear spaces $L_k^n \subset \mathbb{R}^n$. Let e_1, \dots, e_n be the standard basis vectors and $e_0 = -\sum_{i=1}^n e_i$. Then for any subset $I \subset \{0, \dots, n\}$ we can define σ_I to be the cone spanned by those e_i with $i \in I$. As a fan L_k^n consists of the cones σ_I for all $I \subset \{0, \dots, n\}$ with $|I| \leq k$. The tropical variety L_k^n is obtained by putting weight 1 on all maximal cells. The picture below shows from the left to the right L_1^2 , L_2^3 and L_1^3 .

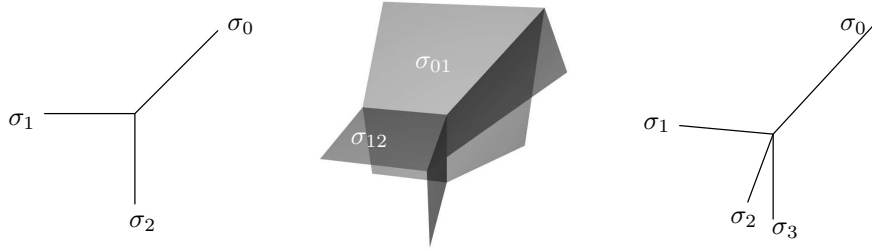

Definition 1.1.7 (Morphisms). A *morphism* $f : \mathcal{X} \rightarrow \mathcal{Y}$ between two tropical varieties $\mathcal{X} \subset V = \Lambda \otimes_{\mathbb{Z}} \mathbb{R}$ and $\mathcal{Y} \subset V' = \Lambda' \otimes_{\mathbb{Z}} \mathbb{R}$ is an affine integer linear map $f : |\mathcal{X}| \rightarrow |\mathcal{Y}|$, i.e. $f = g|_{|\mathcal{X}|} + c$ for a constant $c \in V'$ and an integer linear map $g : V \rightarrow V'$. We call $f_{\text{lin}} := g$ the *linear part* of the morphism f . We call the morphism f *linear* if $c = 0$ and *affine linear* else. In the literature a tropical morphism is usually a map that is only *locally* affine integer linear. However, *all* morphisms in this thesis will be affine linear. We call a linear morphism f *quotient morphism* if f_{lin} is surjective and $f_{\text{lin}}(\Lambda) = \Lambda'$. A tropical *isomorphism* is a morphism $f : \mathcal{X} \rightarrow \mathcal{Y}$ for which there exists an inverse morphism and such that the weights of \mathcal{X} and \mathcal{Y} coincide for suitable polyhedral structures. Note that this definition of morphisms is bad from a categorical point of view, as morphisms for which we have inverse morphisms are not isomorphisms, since morphisms do not "see" the weights of the tropical varieties.

Definition 1.1.8 (Abstract tropical varieties). We define a *tropical topological space* as a tuple $(X, U, \omega, \Phi, \Lambda, \mathcal{X})$ where

- (1) X is a topological space with a dense open subset U
- (2) $\omega : U \rightarrow \mathbb{Q}^*$ is a locally constant function
- (3) $\mathcal{X} \subset V = \Lambda \otimes_{\mathbb{Z}} \mathbb{R}$ is a tropical variety
- (4) $\Phi : X \rightarrow V$ is a homeomorphism onto its image $\Phi(X) = |\mathcal{X}|$

- (5) if $\sigma \in \mathcal{X}^{(0)}$ for some polyhedral structure, then ω attains the constant value $\omega_{\mathcal{X}}(\sigma)$ on $\Phi^{-1}(\sigma^\circ) \cap U$.

Two tropical topological spaces $(X, U, \omega, \Phi, \Lambda, \mathcal{X})$, $(X, U', \omega', \Phi', \Lambda', \mathcal{X}')$ are called equivalent if there is an isomorphism $f : \mathcal{X} \rightarrow \mathcal{X}'$ of tropical varieties such that $\Phi' = f \circ \Phi$. We want to call an equivalence class of tropical topological spaces an *abstract tropical variety*. We also call $(X, U, \omega, \Phi, \Lambda, \mathcal{X})$ a *tropical structure* on X , and sometimes we just call Φ the tropical structure, if the rest is clear from the context. In the notation we will usually omit the structure and denote an abstract tropical variety just by its underlying space X . Note that every tropical variety $\mathcal{X} \subset \Lambda \otimes_{\mathbb{Z}} \mathbb{R}$ defines an abstract tropical variety in an obvious way.

Identifying $(X, U, \omega, \Phi, \Lambda, \mathcal{X})$ with \mathcal{X} we can transfer all constructions from tropical varieties inside a vector space to abstract tropical varieties. For example, an abstract tropical variety $(Y, V, \omega', \Phi', \Lambda', \mathcal{Y})$ is a *subvariety* of $(X, U, \omega, \Phi, \Lambda, \mathcal{X})$, if there are tropical structures with $Y \subset X$, $\Lambda' = \Lambda$, $\Phi' = \Phi|_Y$ and \mathcal{Y} a subvariety of \mathcal{X} . A *morphism* between abstract tropical varieties $(X, U, \omega, \Phi, \Lambda, \mathcal{X})$ and $(Y, V, \omega', \Phi', \Lambda', \mathcal{Y})$ is a map $f : X \rightarrow Y$ for which $\Phi' \circ f \circ \Phi^{-1}$ is a morphism between the tropical varieties \mathcal{X} and \mathcal{Y} .

Now we want to introduce tropical quotients, an important technical tool for gluing tropical moduli spaces.

Definition 1.1.9. Let $L \subset V = \Lambda \otimes_{\mathbb{Z}} \mathbb{R}$ be a rational subvector space, i.e. it is defined by elements in Λ^\vee . A polyhedral complex \mathcal{X} inside V is said to have *lineality space* L , if for each $\sigma \in \mathcal{X}$ and $x \in \sigma$ we have that $(x + L) \cap \mathcal{X}|_{\text{poly}} = (x + L) \cap \sigma$ and that this set is open in the induced subspace topology on $x + L$.

For an affine fan \mathcal{X} we called the cell $\bigcap_{\tau \in \mathcal{X}} \tau = \sigma$ the central cell of \mathcal{X} in Definition 1.1.3. In this case V_σ is a lineality space of \mathcal{X} in the sense above.

A tropical variety \mathcal{X} inside $V = \Lambda \otimes_{\mathbb{Z}} \mathbb{R}$ has lineality space L , if it has a polyhedral structure that has lineality space L . Such a polyhedral structure is called *compatible with* L .

Note that in most of the literature only a maximal L with this property is called a lineality space. If \mathcal{X} is a closed tropical variety, then for any polyhedral structure compatible with L , every $\sigma \in \mathcal{X}$ is closed in V and hence also $(x + L) \cap \sigma$ is closed in $x + L$. As L is connected, we conclude $(x + L) \cap \sigma = x + L$, i.e. $x + L \subset \sigma$. This coincides with the usual definition of a lineality space.

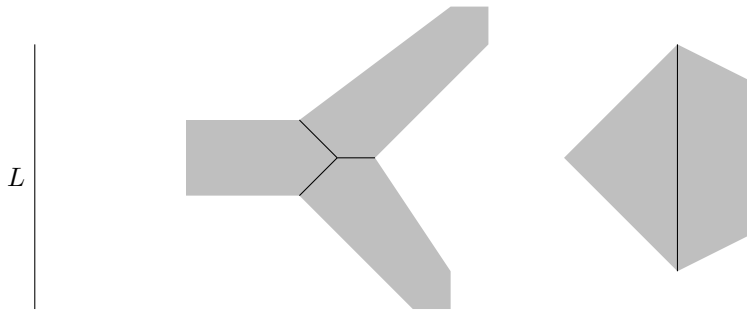

Above we see two examples of partially open polyhedral complexes. The black lines indicate lower dimensional faces. The complex on the left does not have lineality space L , because there are translations of L having non-connected intersection with the support of the complex. Furthermore the images of the cells in the quotient by L do not form a polyhedral complex. The polyhedral complex on the right has lineality space L .

Lemma 1.1.10. Let \mathcal{X} be a polyhedral complex in $V = \Lambda \otimes_{\mathbb{Z}} \mathbb{R}$ with lineality space L . Denote the quotient map $q : V \rightarrow V/L$ and let V/L be equipped with the quotient lattice $q(\Lambda) \cong \Lambda/(\Lambda \cap L)$. Then for all cones $\sigma, \tau \in \mathcal{X}$ we have

- (a) $q(\sigma)$ is a polyhedron of dimension $\dim q(\sigma) = \dim \sigma - \dim L$
- (b) if $\tau \leq \sigma$ then $q(\tau) \leq q(\sigma)$
- (c) $q(\sigma \cap \tau) = q(\sigma) \cap q(\tau)$
- (d) if $q(\tau) = q(\sigma)$ then $\tau = \sigma$
- (e) $\Lambda_{q(\sigma)} = q(\Lambda_\sigma)$. If $\tau \leq \sigma$ is a facet then $\Lambda_{q(\sigma)}/\Lambda_{q(\tau)} \cong \Lambda_\sigma/\Lambda_\tau$ and $u_{q(\sigma)/q(\tau)}$ corresponds to $u_{\sigma/\tau}$ via this isomorphism.

PROOF. (a) Using induction it suffices to consider the case where $\dim L = 1$. We want to choose isomorphisms $L \cap \Lambda \cong \mathbb{Z}$ and $q(\Lambda) \cong \mathbb{Z}^{\dim V - 1}$. This induces an isomorphism $V \cong \mathbb{R}^{\dim V - 1} \times \mathbb{R}$ and we want to call the coordinates $(x, y) \in \mathbb{R}^{\dim V - 1} \times \mathbb{R}$. In these coordinates $L = \{(x, y) \mid y = 0\}$. In the defining inequalities of σ we can assume that those involving y are strict inequalities. Otherwise, for $f(x, y) \leq c$ there would be some $(x_0, y_0) \in \sigma$ with $f(x_0, y_0) = c$. As $((x_0, y_0) + L) \cap \sigma$ is open in $(x_0, y_0) + L$, there must be a neighbourhood U of y_0 in \mathbb{R} with $f(x_0, y) \leq c$ for all $y \in U$, which is a contradiction. After dividing those inequalities involving y by the absolute value of the coefficient of y , we can write

$$(3) \quad \sigma = \{(x, y) \mid h_k(x) R_k c_k \text{ and } f_i(x) + a_i > y \text{ and } g_j(x) + b_j < y \text{ for all } i, j, k\}$$

where R_k stands for one of the relations $\geq, >$ or $=$ and h_k, f_i and g_j are linear forms. We now want to show that

$$(4) \quad q(\sigma) = \{x \mid h_k(x) R_k c_k \text{ and } f_i(x) + a_i > g_j(x) + b_j \text{ for all } i, j, k\}.$$

The inclusion " \subset " is obvious. The other inclusion is true because we have only finitely many i and j and hence, for a fixed x_0 satisfying the relations from (4), we can always find a y_0 with $f_i(x_0) + a_i > y_0 > g_j(x_0) + b_j$ for all i and j . The claim about the dimension follows from the assumption that for each $x \in q(\sigma)$ the fibre $(q|_\sigma)^{-1}(x)$ is open in the fibre $q^{-1}(x)$, which is just a translation of L . Hence every fibre $(q|_\sigma)^{-1}(x)$ is of dimension $\dim L$.

(b) If $\tau \leq \sigma$, then τ is given by replacing some of the R_k in (3) which stand for \geq by $=$. This obviously carries over to $q(\tau)$ and $q(\sigma)$ as in (4).

(c) Clearly $q(\sigma \cap \tau) \subset q(\sigma) \cap q(\tau)$, so let $x \in q(\sigma) \cap q(\tau)$. By the definition of a lineality space we have that $q^{-1}(x) \cap \sigma = q^{-1}(x) \cap \tau \neq \emptyset$, therefore $x \in q(\sigma \cap \tau)$.

(d) By part (c) we have $q(\sigma \cap \tau) = q(\sigma) = q(\tau)$ and as $\sigma \cap \tau$ is a face of σ , it follows from the dimension formula in (a) that $\sigma \cap \tau = \sigma$. By symmetry we obtain $\tau = \sigma$.

(e) By definition $\Lambda_{q(\sigma)} = V_{q(\sigma)} \cap q(\Lambda)$ and $V_{q(\sigma)} = q(V_\sigma)$. We conclude $\Lambda_{q(\sigma)} = q(V_\sigma) \cap q(\Lambda) \supset q(V_\sigma \cap \Lambda) = q(\Lambda_\sigma)$, where the inclusion is actually an equality as we will see now. By the definition of a lineality space, we have $L \subset V_\sigma$ and hence $q^{-1}(q(V_\sigma)) = V_\sigma$. This implies that for every $x \in q(V_\sigma) \cap q(\Lambda)$ any preimage $y \in \Lambda$ under q must automatically also lie in V_σ . We have $\Lambda_{q(\sigma)}/\Lambda_{q(\tau)} = q(\Lambda_\sigma)/q(\Lambda_\tau)$ which is isomorphic to $\Lambda_\sigma/\Lambda_\tau$ after an application of the homomorphism theorem. The vector $u_{q(\sigma)/q(\tau)}$ corresponds to $u_{\sigma/\tau}$ via this isomorphism as there are only two primitive integral vectors in both lattices, so we only need to check the sign. But its easy to see that the images of σ in V_σ/V_τ and $q(\sigma)$ in $q(V_\sigma)/q(V_\tau)$ correspond via the isomorphism $V_\sigma/V_\tau \cong q(V_\sigma)/q(V_\tau)$, hence $u_{\sigma/\tau}$ and $u_{q(\sigma)/q(\tau)}$ correspond via the isomorphism. \square

Construction 1.1.11 (Tropical quotients). Let $\mathcal{X} \subset V = \Lambda \otimes_{\mathbb{Z}} \mathbb{R}$ be a polyhedral complex with lineality space L and let $q : V \rightarrow V/L$ denote the quotient map. Furthermore, let V/L be equipped with the lattice $q(\Lambda)$. Define the quotient complex as

$$q(\mathcal{X}) := \mathcal{X}/L := \{q(\sigma) \mid \sigma \in \mathcal{X}\}.$$

That \mathcal{X}/L is a polyhedral complex follows immediately from the previous lemma. The map $\sigma \mapsto q(\sigma)$ establishes a bijection between the cells of \mathcal{X} and \mathcal{X}/L which preserves the lattice of faces by (a)-(d).

If \mathcal{X} is a tropical polyhedral complex, we define weights $\omega_{\mathcal{X}/L}(q(\sigma)) = \omega_{\mathcal{X}}(\sigma)$ on \mathcal{X}/L for maximal cones $\sigma \in \mathcal{X}$. By (a) images of maximal cones are maximal cones as well, which is

why the above definition of weights makes sense. These weights turn \mathcal{X}/L into a tropical polyhedral complex by part (e) of the lemma. For a tropical variety $[\mathcal{X}]$ with lineality space L , we choose a polyhedral structure \mathcal{X} that is compatible with L and define $[\mathcal{X}]/L := [\mathcal{X}/L]$ as the *tropical quotient variety*. The tropical quotient variety is independent of the choice of polyhedral structures on \mathcal{X} which are compatible with L . A less general quotient working only for closed tropical varieties was previously described in [FR10], Section 5.

We conclude this section with a few definitions that will be useful for our gluing construction in Section 1.5 and for the local study of tropical varieties. Furthermore we want to define smooth tropical varieties, as they are the class of varieties for which we attempt to construct moduli spaces of stable maps.

Construction 1.1.12 (Restriction of tropical varieties). Let \mathcal{X} be a tropical variety and $Y \subset Z$ polyhedral sets such that Y is open in Z and $|\mathcal{X}| \subset Z$. We choose a polyhedral structure on \mathcal{X} and polyhedral complexes \mathcal{Y} and \mathcal{Z} such that $Y = |\mathcal{Y}|_{\text{poly}}$, $Z = |\mathcal{Z}|_{\text{poly}}$, $\mathcal{Y} \leq \mathcal{Z}$ and $\mathcal{X} \leq \mathcal{Z}$. This can be achieved by suitably refining all of them. For a cell $\sigma \in \mathcal{X}$ we have that $\sigma \cap Y$ is open in σ and also a union of relative interiors of cells in \mathcal{X} , so if $\sigma \cap Y \neq \emptyset$ we must have that $\sigma \cap Y$ is just σ without some of its proper faces, in particular $\sigma^\circ \subset \sigma \cap Y$. Now we can define a weighted polyhedral complex

$$\mathcal{X} \cap Y := \{\sigma \cap Y \mid \sigma \in \mathcal{X}\}$$

with weights $\omega_{\mathcal{X} \cap Y}(\sigma \cap Y) := \omega_{\mathcal{X}}(\sigma)$ for maximal cells $\sigma \in \mathcal{X}$ with $\sigma \cap Y \neq \emptyset$. $\mathcal{X} \cap Y$ is clearly balanced, as for some $\tau \in \mathcal{X}^{(1)}$ with $\tau \cap Y \neq \emptyset$ we have $\sigma \cap Y \neq \emptyset$ for all $\sigma \in \mathcal{X}^{(0)}$ with $\sigma \geq \tau$ and hence $\sigma^\circ \subset Y$. We call the tropical variety defined by $\mathcal{X} \cap Y$ the *restriction of \mathcal{X} to Y* . This can be seen to be independent of the choice of polyhedral structures. If we have a tropical variety \mathcal{Y} such that $|\mathcal{Y}| \subset Z$ is open, we define $\mathcal{X} \cap \mathcal{Y} := \mathcal{X} \cap |\mathcal{Y}|$.

The reason why we have Z in the definition, even though the restriction does not really depend on it, is that we need to say $\sigma \cap Y \subset \sigma$ is open, so it is convenient to have a topological space Z containing $|\mathcal{X}|$ and Y such that $Y \subset Z$ is open in it. Typical examples are $Z = V$ and Y an open polyhedron and $Z = |\mathcal{X}|$ and $Y \subset |\mathcal{X}|$ an open polyhedral subset.

Construction 1.1.13 (Preimage variety). Let f be a quotient morphism from $V = \Lambda \otimes_{\mathbb{Z}} \mathbb{R}$ to $V' = \Lambda' \otimes_{\mathbb{Z}} \mathbb{R}$ and let $\mathcal{Z} \subset V'$ be a tropical variety. Fix a polyhedral structure on \mathcal{Z} and consider the preimage complex $f^{-1}\mathcal{Z} = \{f^{-1}\sigma \mid \sigma \in \mathcal{Z}\}$, whose cells are in an obvious inclusion preserving bijection with those of \mathcal{Z} . Hence we can define weights on the maximal cells as $\omega_{f^{-1}\mathcal{Z}}(f^{-1}\sigma) := \omega_{\mathcal{Z}}(\sigma)$. As in the proof of Lemma 1.1.10 part (e) we can use the surjectivity of f onto V' and $f|_{\Lambda}$ onto Λ' to show $f(\Lambda_{f^{-1}\sigma}) = \Lambda_{\sigma}$. Using the homomorphism theorem this shows that if $f^{-1}\sigma > f^{-1}\tau$ is a facet, then $\Lambda_{f^{-1}\sigma}/\Lambda_{f^{-1}\tau} \cong \Lambda_{\sigma}/\Lambda_{\tau}$ and $u_{f^{-1}\sigma/f^{-1}\tau}$ corresponds to $u_{\sigma/\tau}$ via this isomorphism. This proves that the above weights make $f^{-1}\mathcal{Z}$ a balanced polyhedral complex, representing the *preimage variety*. Obviously this does not depend on the choice of polyhedral structure. Note that $f^{-1}\mathcal{Z}$ has lineality space $L = \ker f$ and we have $(f^{-1}\mathcal{Z})/L \cong \mathcal{Z}$. Let $\mathcal{X} \subset V$ be a tropical variety with lineality space L , $|\mathcal{Z}| \subset f|\mathcal{X}|$ and denote $g := f|_{|\mathcal{X}|}$. It follows that $g^{-1}|\mathcal{Z}| = f^{-1}|\mathcal{Z}| \cap |\mathcal{X}| \subset f^{-1}|\mathcal{Z}|$ is open. Hence we can define $g^{-1}\mathcal{Z} := f^{-1}\mathcal{Z} \cap g^{-1}|\mathcal{Z}|$.

Definition 1.1.14 (Neighbourhood). Let \mathcal{X} be a tropical variety, fix a polyhedral structure on it and let $\sigma \in \mathcal{X}$ be a cell. We call an affine tropical fan \mathcal{F} a *neighbourhood of σ° in \mathcal{X}* if the following holds:

- (1) $\sigma^\circ \subset |\mathcal{F}| \subset |\mathcal{X}|$
- (2) for every maximal $\tau \in \mathcal{X}$ with $\tau \geq \sigma$ we have $\tau^\circ \cap |\mathcal{F}| \neq \emptyset$
- (3) for maximal cones $\tau_1 \in \mathcal{X}$ and $\tau_2 \in \mathcal{F}$ (in any polyhedral structure on \mathcal{F}) we have $\omega_{\mathcal{X}}(\tau_1) = \omega_{\mathcal{F}}(\tau_2)$ whenever $\tau_1^\circ \cap \tau_2^\circ \neq \emptyset$.

Recall that by our definition of a fan (Definition 1.1.3), it can be bounded as in the picture below. For example, the restriction $\mathcal{X} \cap \mathcal{X}(\sigma)$ is always a neighbourhood of σ in \mathcal{X} . In the following picture \mathcal{F} is a neighbourhood of the relative interior of the red cell σ in the grey tropical variety.

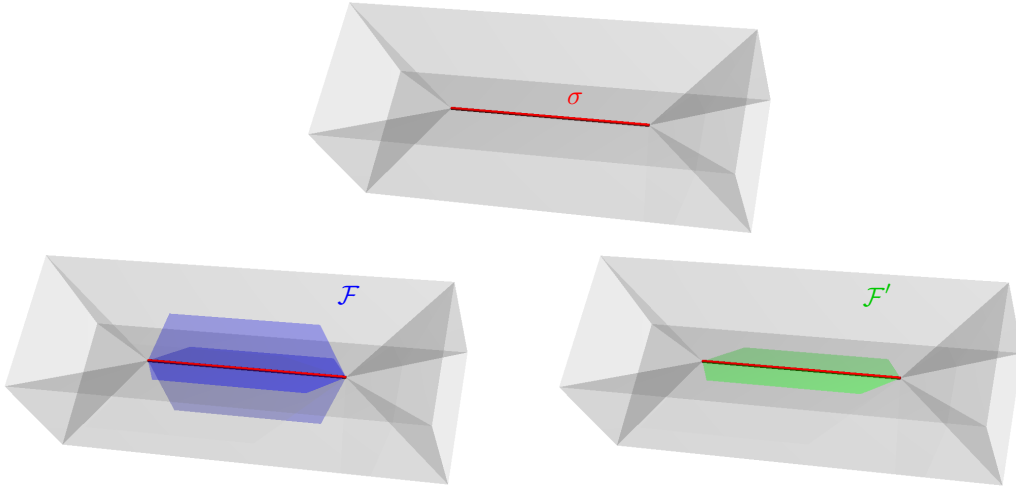

The blue fan \mathcal{F} is a neighbourhood while the green one \mathcal{F}' is not, as it violates condition (2) of the definition.

Definition 1.1.15 (Smooth tropical varieties). We call a tropical variety $\mathcal{X} \subset V$ *smooth* if for every $P \in |\mathcal{X}|$ there are open polyhedral sets $U \subset |\mathcal{X}|$ and $V \subset |L_{k_P}^{n_P} \times \mathbb{R}^{m_P}|$ with $P \in U$ and $0 \in V$ such that $\mathcal{X} \cap U$ is isomorphic to $(L_{k_P}^{n_P} \times \mathbb{R}^{m_P}) \cap V$. Recall the meaning of " \cap " from Construction 1.1.12.

Note that this is much more restrictive than other definitions of smoothness in tropical intersection theory. For example in [FR10] a variety is called smooth if it locally looks like a matroid variety (cf. Section 1.4). As tropicalisations of linear subvarieties of a torus are always matroid varieties, this is the same as to say \mathcal{X} is locally tropical linear. Note that a closed smooth tropical variety has a unique coarsest polyhedral structure, cf. the next lemma. The picture below shows two smooth varieties.

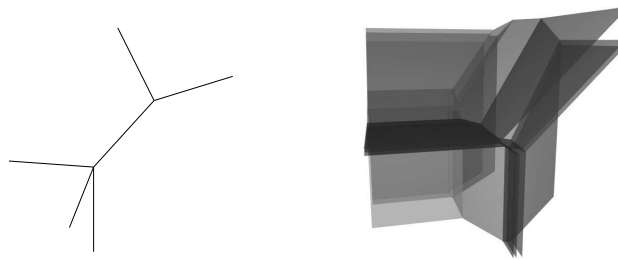

The following lemma was proven in cooperation with Simon Hampe.

Lemma 1.1.16. *A closed smooth tropical variety has a unique coarsest polyhedral structure.*

PROOF. Let $\mathcal{X} \subset V = \Lambda \otimes_{\mathbb{Z}} \mathbb{R}$ be a tropical polyhedral complex, such that $[\mathcal{X}]$ is a smooth tropical variety. We want to find the coarsest polyhedral structure by removing all superfluous subdivisions. For the moment we want to denote a cell $\tau \in \mathcal{X}^{(1)}$ *two-valent*, if it is a face of exactly two maximal cells of \mathcal{X} . We want to call two cells $\sigma, \sigma' \in \mathcal{X}^{(0)}$

equivalent, if there exist cells $\sigma_0, \dots, \sigma_r \in \mathcal{X}^{(0)}$ and two-valent cells $\tau_1, \dots, \tau_r \in \mathcal{X}^{(1)}$ such that $\sigma_0 = \sigma$, $\sigma_r = \sigma'$ and $\sigma_i \geq \tau_{i+1} \leq \sigma_{i+1}$ for $i = 0, \dots, r-1$. We then write $\sigma \sim \sigma'$. Note that $\omega_{\mathcal{X}}(\sigma) = \omega_{\mathcal{X}}(\sigma')$ holds for $\sigma \sim \sigma'$ by the balancing condition. Fix a maximal cell $\sigma \in \mathcal{X}^{(0)}$ and let $S_\sigma := \{\sigma' \in \mathcal{X}^{(0)} \mid \sigma' \sim \sigma\}$ and $S_\sigma := |S_\sigma|_{\text{poly}}$. We want to show that S_σ is a polyhedron, i.e. it is convex, and that arbitrary S_σ and $S_{\bar{\sigma}}$ intersect in a common face. Once we proved this, it is then clear that the set of all S_σ together with all of their faces forms a tropical polyhedral complex \mathcal{X}' with weights $\omega_{\mathcal{X}'}(S_\sigma) := \omega_{\mathcal{X}}(\sigma)$. Furthermore, it is obvious from the construction that $\{S_\sigma \mid \sigma \in \mathcal{X}^{(0)}\}$ is invariant under refinements of \mathcal{X} . Choosing a common refinement of two different polyhedral structures on $[\mathcal{X}]$, we conclude that $(\mathcal{X}', \omega_{\mathcal{X}'})$ only depends on $[\mathcal{X}]$, which proves uniqueness. As the cells of \mathcal{X}' are unions of cells of \mathcal{X} , \mathcal{X} is a refinement of \mathcal{X}' . As this is true for every polyhedral structure of $[\mathcal{X}]$, \mathcal{X}' must be the coarsest one.

Assume that S_σ is not convex. Then there are two points $x, y \in S_\sigma$ such that the straight line segment $[x, y]$ between them is not contained in S_σ . Let $\gamma : [0, 1] \rightarrow S_\sigma$ be a piecewise affine linear, continuous path from x to y . Let $s = \sup\{t \in [0, 1] \mid [\gamma(t), y] \not\subset S_\sigma\}$ and let $\varepsilon > 0$ such that $\gamma|_{[s-\varepsilon, s]}$ is affine linear. The points $y, \gamma(s-\varepsilon)$ and $\gamma(s)$ span a plane triangle T as in the following picture.

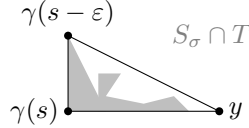

Then $S_\sigma \cap T$ is not convex, as by definition of s we have $[\gamma(s-\varepsilon), \gamma(s)] \cup [\gamma(s), y] \subset S_\sigma \cap T$, but $[\gamma(s-\varepsilon), y] \not\subset S_\sigma$. As $S_\sigma \cap T$ is a closed plane polyhedral set, the following statement follows easily: There is a point $z \in S_\sigma \cap T$ such that for every open cube $Q \subset V$ which is centred at z the set $S_\sigma \cap Q$ is not convex. By choosing Q sufficiently small, we can assume that $\mathcal{X} \cap Q = \{\sigma' \cap Q \mid \sigma' \in \mathcal{X}\}$ is an affine fan and that there is an isomorphism $f : \mathcal{X} \cap Q \xrightarrow{\sim} (L_k^n \times \mathbb{R}^m) \cap U$ with $f(z) = 0$ for a suitable open polyhedron U , as $[\mathcal{X}]$ is smooth. Since f is an isomorphism, two-valent cells of $f(\mathcal{X} \cap Q)$ and $\mathcal{X} \cap Q$ correspond to each other. Therefore $f(S_\sigma \cap Q)$ is a union of equivalence classes with respect to \sim . For $L_k^n \times \mathbb{R}^m$ the existence of a coarsest polyhedral structure is obvious. As U is convex, this coarsest structure carries over to $(L_k^n \times \mathbb{R}^m) \cap U$. So we conclude that the support of $f(S_\sigma \cap Q)$ must be a union of maximal cells of $(L_k^n \times \mathbb{R}^m) \cap U$. By construction and balancing, S_σ is contained in an affine linear subspace of V of dimension $\dim S_\sigma = \dim \mathcal{X} = k + m$. Hence the same is true for $f(S_\sigma \cap Q)$ and we conclude that this must be a single maximal cell, thus convex. But as f is an isomorphism, also $S_\sigma \cap Q$ must be convex which is a contradiction. Therefore S_σ must be convex.

Let $S_\sigma \cap S_{\bar{\sigma}} = F_1$. By what we already proved, this is a polyhedron. Hence there is an inclusion minimal face F of S_σ that contains F_1 . Assume that F_1 is not a face of S_σ . If $\dim F_1 = \dim F$, there are points $x \in F^\circ \setminus F_1$ and $y \in F_1^\circ$. Let $s = \sup\{t \in [0, 1] \mid (1-t)x + ty \notin F_1\}$ and let $z = (1-s)x + sy$. Furthermore let Q be, as above, a sufficiently small open cube which is centred at z , such that $\mathcal{X} \cap Q$ is an affine fan and $f : \mathcal{X} \cap Q \xrightarrow{\sim} (L_k^n \times \mathbb{R}^m) \cap U$, with $f(z) = 0$ for a suitable open polyhedron U . We conclude that $f(S_\sigma \cap Q)$ and $f(S_{\bar{\sigma}} \cap Q)$ are maximal cells of $(L_k^n \times \mathbb{R}^m) \cap U$. Now $f([x, y] \cap Q)$ is a line segment through 0 which is contained in the maximal cell $f(S_\sigma \cap Q)$, therefore it is contained in a lineality space of $(L_k^n \times \mathbb{R}^m) \cap U$. Hence it must also be contained in $f(S_{\bar{\sigma}} \cap Q)$ and thus $[x, y] \cap Q \subset F_1$, which is a contradiction. Now we consider $\dim F_1 < \dim F$. As F is inclusion minimal, F_1 is not contained in a proper face of F . Hence there are $\lambda \in \Lambda^\vee$ and $x, y \in F$ such that $\lambda|_{F_1} = 0$, $\lambda(x) > 0$ and $\lambda(y) < 0$. If we define z as before, the same arguments will lead to a contradiction. So we conclude that $F = F_1$ is a face of S_σ . By symmetry, this must then also be a face of $S_{\bar{\sigma}}$. \square

Remark 1.1.17. Note that a smooth tropical variety that is not closed does not need to admit a unique coarsest polyhedral structure. For example consider the following picture of the support of a partially open tropical variety, where we suppose that the gray set is open in the plane.



It is smooth, as it is locally isomorphic to \mathbb{R}^2 , but since it is not convex, it has to be subdivided to equip it with a polyhedral structure. However, such a subdivision is not unique.

1.2. Introduction to tropical moduli spaces

In this section we want to review the construction of the well known tropical moduli spaces $\mathcal{M}_{0,n}$ of n -marked abstract tropical curves and $\mathcal{M}_0(\mathbb{R}^m, \Delta)$ of tropical stable maps of degree Δ , cf. [GKM09]. This is necessary, as we intend to construct the space $\mathcal{M}_0(\mathcal{X}, \Delta)$ of curves in \mathcal{X} as a tropical subvariety of $\mathcal{M}_0(\mathbb{R}^m, \Delta)$. Additionally we want to construct similar spaces with the new additional feature of a set I of bounded leaves for the abstract curves, ${}_I\mathcal{M}_{0,n}$ and ${}_I\mathcal{M}_0(\mathbb{R}^m, \Delta)$, which we will use to glue tropical curves from local pieces in Section 1.5.

We will begin with a definition of a graph which is very useful to describe dual graphs of marked stable curves, as it comes from a paper of K. Behrend and Y. Manin on moduli spaces of stable maps, [BM96]. We adapt the definitions of metric graphs and tropical curves to this graph definition, as tropical curves are (almost) dual graphs of stable maps in a natural way (cf. Theorem 2.2.18).

Definition 1.2.1 (Graphs). A *graph* is a tuple $G = (V, F, j, \partial)$ such that V is a finite set whose elements are called *vertices*, F is a finite set whose elements are called *flags*, $\partial : F \rightarrow V$ is a map and $j : F \rightarrow F$ an involution. This definition is from [BM96]. We will usually use the notation $V_G := V$, $F_G := F$, $\partial_G := \partial$ and $j_G := j$. The set of *edges* of G will be denoted $E_G := \{\{f_1, f_2\} \subset F_G \mid j_G(f_1) = f_2 \neq f_1\}$. For a vertex $v \in V_G$ we call $\text{val}(v) := |\partial_G^{-1}(v)|$ the *valence* of v . If the graph G is clear from the context we will usually use the notation $F^v := \partial_G^{-1}(v)$. We say that vertices v and w are *adjacent* if there is an edge $\{f, f'\} \in E_G$ with $\partial_G(f) = v$ and $\partial_G(f') = w$. We say that $v \in V_G$ and $f \in F_G$ are *incident* to each other if $\partial_G(f) = v$, similarly $v \in V_G$ and $e = \{f, f'\} \in E_G$ are *incident* if $\partial_G(f) = v$. We call a flag f *leaf* if $j_G(f) = f$ or $\partial_G^{-1}(\partial_G(f)) = \{f\}$. Let $L_G \subset F_G$ denote the set of leaves.

A *connected component* of G is given by a graph H where V_H is a subset of V_G , which is maximal with the property that for any two $v, w \in V_H$ there exist edges $\{f_1, f'_1\}, \dots, \{f_r, f'_r\}$ of G with $\partial_G(f_1) = v$, $\partial_G(f'_r) = w$ and $\partial_G(f'_i) = \partial_G(f_{i+1})$ for $i = 1, \dots, r-1$. Furthermore H shall satisfy $F_H = \partial_G^{-1}(V_H)$, $j_H = j_G|_{F_H}$ and $\partial_H = \partial_G|_{F_H}$. The *genus* of a graph is the number $|E_G| - |V_G| + c$, where c is the number of its connected components. A graph is called *tree* if is connected (i.e. it has only one connected component) and of genus zero. If G is of genus zero, we will usually also write an edge $\{f_1, f_2\}$ as $\{\partial_G(f_1), \partial_G(f_2)\}$.

We call a bijection $l_G : L_G \rightarrow K$ a *K-labelling* of G and the pair (G, l_G) a *K-labelled graph*. An *isomorphism* of K -labelled graphs $(G_1, l_{G_1}), (G_2, l_{G_2})$ is a pair (ϕ_V, ϕ_F) such that $\phi_V : V_{G_1} \rightarrow V_{G_2}$ and $\phi_F : F_{G_1} \rightarrow F_{G_2}$ are bijections satisfying $\partial_{G_2} \circ \phi_F = \phi_V \circ \partial_{G_1}$ and $\phi_F \circ j_{G_1} = j_{G_2} \circ \phi_F$ and $l_{G_1}(x) = l_{G_2}(\phi_F(x))$ for all leaves $x \in L_{G_1}$.

We will usually omit the labelling in the notation and just write G for a labelled graph (G, l_G) , if it the labelling is clear from the context.

Definition 1.2.2 (Metric graphs). A *metric graph* is a tuple $\Gamma = (G, (I_f)_{f \in F_G})$ where G is a graph and the $I_f = [0, l_f) \subset \mathbb{R}$ are intervals such that $l_f = \infty$ if f is a leaf with $j_G(f) = f$ and $l_f \in (0, \infty)$ else. Furthermore we require $I_{f_1} = I_{f_2}$ if $\{f_1, f_2\} \in E_G$. We say a leaf is

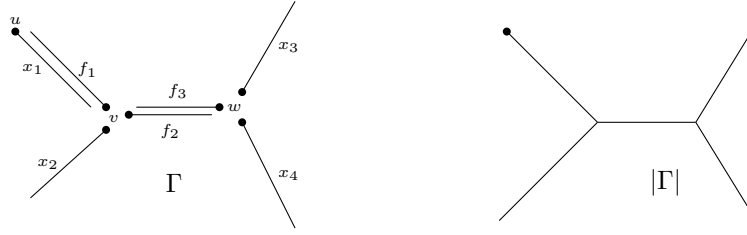

FIGURE 1. In the picture a flag f is represented by the half open interval I_f associated to it, with a fat point as boundary. The graph has vertices u, v and w and flags $x_1, x_2, x_3, x_4, f_1, f_2$ and f_3 , where the x_i are the leaves of which only x_1 is bounded. $\partial_{G(\Gamma)}$ maps a flag to the vertex next to the fat point on it and $j_{G(\Gamma)}$ maps a flag to the flag lying parallel next to it. Hence the graph has the two edges $\{x_1, f_1\}$ and $\{f_2, f_3\}$.

bounded if it is an edge and unbounded else. We call $G(\Gamma) := G$ the *underlying graph* of Γ . Define an equivalence relation on $\coprod_{f \in F_G} I_f$ as $P \sim Q$ if and only if one of the following conditions holds

- $P \in I_{f_1}^\circ$ and $Q \in I_{f_2}^\circ$ for some edge $\{f_1, f_2\} \in E_G$ and $P = l_{f_1} - Q \in I_{f_1}$
- $P \in \partial I_{f_1}$ and $Q \in \partial I_{f_2}$ for flags f_1 and f_2 with $\partial_G(f_1) = \partial_G(f_2)$.

We then define the *support* of Γ as the metric topological space $|\Gamma| = (\coprod_{f \in F_G} I_f) / \sim$ and we denote the natural map $q_\Gamma : \coprod_{f \in F_G} I_f \rightarrow |\Gamma|$. See Figure 1 for an example of how this works. A metric graph Γ is called *connected* if $|\Gamma|$ is, which is the case if and only if the underlying graph is connected. We define its *genus* to be the first Betti number $\dim H^1(|\Gamma|, \mathbb{Z})$, which equals the genus of the underlying graph. When we talk about a *vertex* of Γ we mean a vertex $v \in V_G$ or the associated point $q_\Gamma(\partial I_f) \in |\Gamma|$ for some $f \in F_G$ with $\partial_G(f) = v$, which we will also denote v by abuse of notation. Similarly a *flag* of Γ denotes a flag $f \in F_G$ and its image $q_\Gamma(I_f^\circ)$ in $|\Gamma|$ alike. Furthermore an *edge* of Γ denotes an edge $e = \{f_1, f_2\}$ of the underlying graph and its image $q_\Gamma(I_{f_1}^\circ) = q_\Gamma(I_{f_2}^\circ)$ in $|\Gamma|$. The *length* of e is the length of the edge in the metric of $|\Gamma|$, i.e. l_{f_1} . An *unbounded edge* of Γ denotes an unbounded leaf f and also its image $q_\Gamma(I_f^\circ)$ in $|\Gamma|$.

Note that by our definition edges and flags are open in $|\Gamma|$. The reason for this will be explained in Definition 1.5.1.

Definition 1.2.3 (Abstract tropical curves). A K -marked abstract tropical curve is a connected metric graph Γ together with a K -labelling $l_{G(\Gamma)}$ of its underlying graph $G(\Gamma)$. For such an object we will usually write the set of leaves as $L_{G(\Gamma)} = \{x_i \mid i \in K\}$, where $l_{G(\Gamma)}(x_i) = i$. We then write $(\Gamma, (x_i)_{i \in K})$ for the K -marked abstract tropical curve. We say the curve is n -marked if $K = [n] := \{1, \dots, n\}$, which is often the case.

Let $(\Gamma, (x_i)_{i \in K})$ and $(\Gamma', (x'_i)_{i \in K})$ be two K -marked abstract tropical curves such that $\Gamma = (G, (I_f)_{f \in F_G})$ and $\Gamma' = (G', (I_{f'})_{f' \in F_{G'}})$. An *isomorphism* between these two K -marked abstract tropical curves is an isometric isomorphism $\phi : |\Gamma| \rightarrow |\Gamma'|$ such that for each leaf x_i there exists an open interval $J_i \subset I_{x_i}$ with $(\phi \circ q_\Gamma)(J_i) \subset q_{\Gamma'}(I_{x'_i})$. Here q_Γ and $q_{\Gamma'}$ are as in the previous definition.

This definition of abstract tropical curves slightly differs from the one in [GKM09]. This is because we will also need curves with only two leaves and the information of an underlying graph will be useful when we cut and glue tropical curves in Section 1.5. Furthermore we can easily compare the underlying graph of a tropical curve to the dual graphs of stable curves in Chapter 2.

Definition 1.2.4 (The tropical moduli space ${}_I\mathcal{M}_{0,n}$). Let $I \subset K$ and $|K| + |I| \geq 3$. Let ${}_I\mathcal{M}_{0,K}$ denote the set of all isomorphism classes of K -marked abstract tropical curves of genus zero, where a leaf is bounded if and only if its label is in I . If $I = \emptyset$ we denote the space just $\mathcal{M}_{0,K}$ and if $I = K$ we denote it by $\mathcal{M}'_{0,K}$. We usually consider n -marked abstract tropical curves, i.e. $K = [n]$, in which case we replace K by n in the notation. When we write $(\Gamma, (x_i)_{i \in K}) \in {}_I\mathcal{M}_{0,K}$ we always mean the isomorphism class of $(\Gamma, (x_i)_{i \in K})$.

Note that a K -marked abstract tropical curve of genus zero has no non-trivial automorphisms if $|K| + |I| \geq 3$. The condition $|K| + |I| \geq 3$ also implies $|K| \geq 2$.

Definition 1.2.5 (Combinatorial types). A *combinatorial type* of K -marked abstract tropical curves is an isomorphism class α of connected K -labelled graphs such that if $|K| \geq 3$ the elements of α have no two-valent vertices and if $|K| = 2$ the elements of α have exactly one two-valent vertex.

Now we want to assign combinatorial types to tropical curves. We assign the same combinatorial type to K -marked abstract tropical curves which are isomorphic. Every K -marked abstract tropical curve $(\Gamma, (x_i)_{i \in K})$ is isomorphic to a tropical curve $(\Gamma^0, (x'_i)_{i \in K})$ such that the number of two-valent vertices of the underlying graph $G(\Gamma^0)$ is minimal. For $|K| \geq 3$ this means that $G(\Gamma^0)$ has no two-valent vertex. For $|K| = 2$ there is exactly one two-valent vertex, which is necessary to separate the two leaves. We define the combinatorial type of $(\Gamma^0, (x'_i)_{i \in K})$ to be the isomorphism class of the K -labelled graph $G(\Gamma^0)$.

Before we endow ${}_I\mathcal{M}_{0,K}$ with the structure of an abstract tropical variety, we want to define three important maps which will then turn out to be tropical morphisms.

Definition 1.2.6 (Forgetful map). Let $I \subset K' \subset K$ with $|K'| + |I| \geq 3$ and let $(\Gamma, (x_i)_{i \in K}) \in {}_I\mathcal{M}_{0,K}$ be of combinatorial type α , such that $\Gamma = (G, (I_f)_{f \in F_G})$ and $G \in \alpha$. Let H denote the graph that is obtained from G by deleting the flags $\{x_i \mid i \in K \setminus K'\}$ and restricting the maps ∂_G and j_G . Define the metric graph $\tilde{\Gamma} := (H, (I_f)_{f \in F_H})$ and the forgetful map

$$\tilde{\text{ft}}_{K'} : {}_I\mathcal{M}_{0,K} \longrightarrow {}_I\mathcal{M}_{0,K'}, \quad \tilde{\text{ft}}_{K'}(\Gamma, (x_i)_{i \in K}) := (\tilde{\Gamma}, (x_i)_{i \in K'}).$$

This is a tropical morphism as we will see in Construction 1.2.9. For example $\tilde{\text{ft}}_{\{1,3,4\}}$ of the abstract tropical curve in Figure 1 yields the following picture:

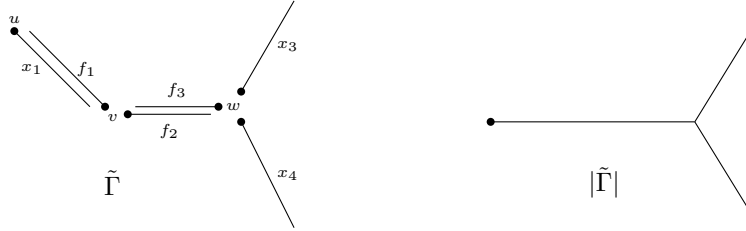

Definition 1.2.7 (Forgetting the length of a bounded leaf). Let $J \subset I \subset K$ with $|K| + |J| \geq 3$. Let $(\Gamma, (x_i)_{i \in K}) \in {}_I\mathcal{M}_{0,K}$ be of combinatorial type α , such that $\Gamma = (G, (I_f)_{f \in F_G})$ and $G \in \alpha$. We define a graph $H = (V_H, F_H, j_H, \partial_H)$ where

$$V_H := V_G \setminus \partial_G(\{x_i \mid i \in I \setminus J\}) \quad \text{and} \quad F_H := F_G \setminus j_G(\{x_i \mid i \in I \setminus J\}),$$

$\partial_H(x_i) := \partial_G(j_G(x_i))$ for $i \in I \setminus J$ and $\partial_H(f) := \partial_G(f)$ for all other flags in F_H . Furthermore $j_H(x_i) := x_i$ for $i \in I \setminus J$ and $j_H(f) := j_G(f)$ for all other flags f in F_H . We define intervals $J_f := [0, \infty)$ for $f \in \{x_i \mid i \in I \setminus J\}$ and $J_f := I_f$ for $f \in F_H \setminus \{x_i \mid i \in I \setminus J\}$. Note that G and H have the same leaves, so we can keep the K -labelling. Let $\tilde{\Gamma} := (H, (J_f)_{f \in F_H})$ and define

$$\tilde{q}_I^J : {}_I\mathcal{M}_{0,K} \longrightarrow {}_J\mathcal{M}_{0,K}, \quad \tilde{q}_I^J(\Gamma, (x_i)_{i \in K}) := (\tilde{\Gamma}, (x_i)_{i \in K}).$$

This is a quotient morphism, as we will see in Construction 1.2.9. If $J = \emptyset$ we abbreviate the map by $\tilde{q}_I^\emptyset := \tilde{q}_I$. If we take for example $\tilde{q}_{\{1\}}$ of the abstract tropical curve in Figure 1 we obtain the following picture:

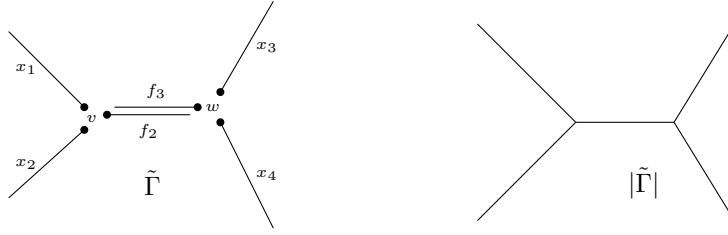

Definition 1.2.8 (The distance map). Let $(|K|, |I|) \neq (2, 1)$ and $i, j \in K$. Let $(\Gamma, (x_i)_{i \in K}) \in {}_I\mathcal{M}_{0,K}$ such that $G(\Gamma)$ is in a combinatorial type of K -marked abstract tropical curves. We define $\tilde{d}_{ij}(\Gamma, (x_i)_{i \in K})$ as the distance between the vertices $\partial_{G(\Gamma)}(x_i)$ and $\partial_{G(\Gamma)}(x_j)$ measured in $|\Gamma|$. If $(|K|, |I|) = (2, 1)$, this map would still depend on the representative of the element in ${}_I\mathcal{M}_{0,K}$. We therefore define $\tilde{d}_{ij} = 0$ for $K = \{i, j\}$ in this case, which is the suitable choice to obtain an embedding in the next construction.

The picture below shows all cases for $|K| = 2$ with underlying graph in a combinatorial type. In the first picture we see that $\partial_{G(\Gamma)}(x_2)$ can move and hence change the distance.

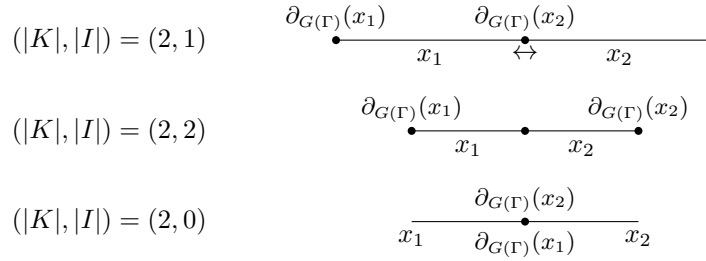

The map \tilde{d}_{ij} will turn out to be a tropical morphism if $i, j \in I$, cf. Construction 1.2.9.

Construction 1.2.9 (Tropical structure of $\mathcal{M}_{0,n}$). Assume $|K| + |I| \geq 3$, let $\binom{K}{2}$ denote the set of all two-element subsets of K and for $i \in K$ let u_i denote the image of the standard basis vector $e_i \in \mathbb{R}^K$ under the linear embedding $\mathbb{R}^K \rightarrow \mathbb{R}^{\binom{K}{2}}$, $(a_i)_i \mapsto (a_i + a_j)_{\{i,j\}}$. Let $U_{K,I} := \langle u_i \mid i \notin I \rangle$ and consider the quotient $q: \mathbb{R}^{\binom{K}{2}} \rightarrow \mathbb{R}^{\binom{K}{2}} / U_{K,I} =: Q_{K,I}$. Then

$$\tilde{d}_{K,I} := q \circ \left(\prod_{\{i,j\} \in \binom{K}{2}} \tilde{d}_{ij} \right) : {}_I\mathcal{M}_{0,K} \rightarrow Q_{K,I}$$

embeds ${}_I\mathcal{M}_{0,K}$ as support of a partially open simplicial fan of pure dimension $|K| - 3 + |I|$. For $|K| \geq 3$ this is a slight modification of Theorem 4.2 of [SS04]. The cases with $|K| = 2$ are easy to see. For simplicity we will also write u_i for $q(u_i)$ in the following.

For $2 \leq |J| \leq |K| - 2$ we define the vector v_J as follows: Let $(\Gamma_J, (x_i)_{i \in K})$ denote a K -marked tropical curve where all bounded leaves are of length one and there is exactly one additional edge, also of length one, such that all leaves x_i with $i \in J$ are on one side of this edge and the rest lies on the other. Then v_J is the unique vector in $Q_{K,I}$ such that $\tilde{d}_{K,I}(\Gamma_J, (x_i)_{i \in K}) = v_J + \sum_{i \in I} u_i$. Note that in general $v_J \notin \tilde{d}_{K,I}({}_I\mathcal{M}_{0,K})$ and that $v_J = v_{K \setminus J}$. The following picture shows an example of the curve represented by $v_J + u_1 + u_4 + u_5$ in ${}_I\mathcal{M}_{0,7}$ for $I = \{1, 4, 5\}$ and $J = \{5, 6, 7\}$.

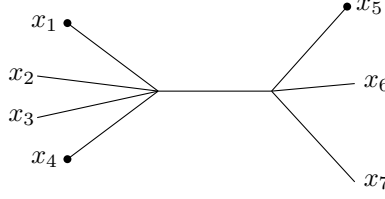

We define the underlying lattice of $Q_{K,I}$ as

$$\Lambda_{K,I} := \langle u_i, v_J \mid i \in I, J \subset K \text{ with } 2 \leq |J| \leq |K| - 2 \rangle_{\mathbb{Z}}.$$

In the special case $I = \emptyset$ we abbreviate $\Lambda_K := \Lambda_{K,I}$ and $Q_K := Q_{K,I}$ and for $I = K$ we write $\Lambda'_K := \Lambda_{K,K}$ and $Q'_K := Q_{K,K} \cong \mathbb{R}^{\binom{K}{2}}$.

Each chain of subsets $\mathcal{J} = (J_1 \subsetneq \dots \subsetneq J_r \subset K)$ with $2 \leq |J_1|$ and $|J_r| \leq |K| - 2$ defines a cone

$$\langle \mathcal{J} \rangle := \left\{ \sum_{j=1}^r \alpha_j v_{J_j} + \sum_{i \in I} \beta_i u_i \mid \alpha_j \in \mathbb{R}_{\geq 0} \text{ and } \beta_i \in \mathbb{R}_{> 0} \right\}$$

in $Q_{K,I}$. The following is also a slight modification of [SS04], Theorem 4.2 if $|K| \geq 3$. For $|K| = 2$ it will be easy to see. The collection of all such cones $\langle \mathcal{J} \rangle$ defines a polyhedral complex $\mathcal{F}_{K,I}$ with support $\tilde{d}_{K,I}({}_I\mathcal{M}_{0,K})$. The interior $\langle \mathcal{J} \rangle^\circ$ corresponds to all K -marked abstract tropical curves with bounded leaves I of a certain combinatorial type, i.e. ${}_I\mathcal{M}_{0,n}$ has a stratification by combinatorial types. If we assign weight one to each maximal cone, we obtain a tropical polyhedral complex and hence a tropical variety which we also want to denote $\mathcal{F}_{K,I}$ for the moment.

We want to equip ${}_I\mathcal{M}_{0,K}$ with the topology induced by the euclidean topology on $Q_{K,I}$ and the embedding $\tilde{d}_{K,I}$. If U is the preimage under $\tilde{d}_{K,I}$ of the union of the relative interiors of all maximal cones of $\mathcal{F}_{K,I}$ and $\omega : U \rightarrow \mathbb{Q}$ is constant one,

$$({}_I\mathcal{M}_{0,K}, U, \omega, \tilde{d}_{K,I}, \Lambda_{K,I}, \mathcal{F}_{K,I})$$

is an abstract tropical variety.

Note that $I = \emptyset$ is the only case where ${}_I\mathcal{M}_{0,K}$ is a closed tropical variety and where the vectors v_J are actually contained in $\tilde{d}_{I,K}({}_I\mathcal{M}_{0,K})$. Also note that if $|K| = n$ there is a natural bijection identifying ${}_I\mathcal{M}_{0,K}$ with ${}_I\mathcal{M}_{0,n}$, which is an isomorphism of abstract tropical varieties.

Let us explain shortly why the three maps from Definitions 1.2.6, 1.2.7 and 1.2.8 are morphisms.

For $J \subset I$ with $|K| + |J| \geq 3$ the map $\tilde{q}_J^I : {}_I\mathcal{M}_{0,K} \rightarrow {}_J\mathcal{M}_{0,K}$ is a morphism, because the quotient map $\tilde{q} : Q_{K,I} \rightarrow Q_{K,J} \cong Q_{K,I} / \langle u_i \mid i \in I \setminus J \rangle_{\mathbb{R}}$ satisfies $\tilde{q}(\Lambda_{K,I}) = \Lambda_{K,J}$ and $\tilde{q}_J^I = \tilde{d}_{K,J}^{-1} \circ \tilde{q} \circ \tilde{d}_{K,I}$. By abuse of notation we will also denote \tilde{q} by \tilde{q}_I^J .

Consider the forgetful map $\tilde{f}t_{K'} : {}_I\mathcal{M}_{0,K} \rightarrow {}_I\mathcal{M}_{0,K'}$ for any $I \subset K' \subset K$ with $|K'| + |I| \geq 3$. The projection $\text{pr} : \mathbb{R}^{\binom{K}{2}} \rightarrow \mathbb{R}^{\binom{K'}{2}}$ satisfies $\text{pr}(U_{K,I}) = U_{K',I}$ and hence it induces a linear map $\tilde{\text{pr}} : Q_{K,I} \rightarrow Q_{K',I}$. One can check that $\tilde{\text{pr}}(\Lambda_{K,I}) \subset \Lambda_{K',I}$ and $\tilde{f}t_{K'} = \tilde{d}_{K',I}^{-1} \circ \tilde{\text{pr}} \circ \tilde{d}_{K,I}$, cf. Proposition 3.12 in [GKM09]. Hence $\tilde{f}t_{K'}$ is a morphism. By abuse of notation we also denote $\tilde{\text{pr}}$ by $\tilde{f}t_{K'}$.

For a pair $i, j \in I$ consider the distance map \tilde{d}_{ij} . The projection $\text{pr} : \mathbb{R}^{\binom{K}{2}} \rightarrow \mathbb{R} \cong \langle e_{\{i,j\}} \rangle_{\mathbb{R}}$ satisfies $\text{pr}(U_{K,I}) = 0$ and hence induces a linear map $\tilde{\text{pr}} : Q_{K,I} \rightarrow \mathbb{R}$. This map has the properties $\tilde{\text{pr}}(\Lambda_{K,I}) \subset \mathbb{Z}$ and $\tilde{d}_{ij} = \tilde{\text{pr}} \circ \tilde{d}_{K,I}$. Hence \tilde{d}_{ij} is a morphism.

Remark 1.2.10. In the following we will usually identify ${}_I\mathcal{M}_{0,K}$ with its image under $\tilde{d}_{K,I}$, i.e. the tropical variety $\mathcal{F}_{K,I}$ in the notation from the previous construction.

Now we state a lemma which will play a key role in the later chapters.

Lemma 1.2.11. *Let the notation be as in Construction 1.2.9. A vector $x \in Q_K$ is zero if and only if $\tilde{ft}_{K'}(x) = 0$ for all $K' \subset K$ with $|K'| = 4$.*

PROOF. As $\tilde{ft}_{K'}$ is linear, one direction is obvious. We denote the standard basis vectors of $\mathbb{R}^{\binom{K}{2}}$ by e_{ij} . Let $\tilde{x} \in \mathbb{R}^{\binom{K}{2}}$ denote a vector satisfying $q(\tilde{x}) = x$. The assumption $\tilde{ft}_{K'}(x) = 0$ means that for $\tilde{x} = \sum_{ij} \lambda_{ij} e_{ij}$ and every $K' \subset K$ with $|K'| = 4$, it follows that there is a vector $\mu \in \mathbb{R}^{K'}$ such that $\lambda_{ij} = \mu_i + \mu_j$ for all $i, j \in K'$ with $i \neq j$. Thus $\lambda_{ik} + \lambda_{jl} = \lambda_{ij} + \lambda_{kl}$ for arbitrary four different indices i, j, k, l . This means that the assignment

$$\lambda_i := \frac{1}{2}(\lambda_{ij} + \lambda_{ik} - \lambda_{jk}) \quad \text{for any } j, k \neq i$$

is well-defined because if m is another index we have

$$\begin{aligned} \frac{1}{2}(\lambda_{ij} + \lambda_{ik} - \lambda_{jk}) &= \frac{1}{2}(\lambda_{im} + \lambda_{ik} - \lambda_{mk}) + \frac{1}{2}(\lambda_{ij} - \lambda_{im} + \lambda_{mk} - \lambda_{jk}) \\ &= \frac{1}{2}(\lambda_{im} + \lambda_{ik} - \lambda_{mk}). \end{aligned}$$

We also have that $\lambda_i + \lambda_j = \lambda_{ij}$, but this means just that $\tilde{x} \in U_{K,\emptyset}$, so $x = 0$ in Q_K . □

Definition 1.2.12 (Tropical stable maps). Let K be a finite set with $|K| \geq 2$, let $I \subset K$ and $\Delta = (\delta_i)_{i \in K} \in (\mathbb{Z}^m)^K$. For a K -marked abstract tropical curve $(\Gamma, (x_i)_{i \in K})$ with bounded leaves I we define $|\Gamma|^\circ$ as $|\Gamma|$ without its one-valent vertices. A tuple $(\Gamma, (x_i)_{i \in K}, h)$ is called *tropical stable map (of degree Δ)* if $(\Gamma, (x_i)_{i \in K})$ is a K -marked abstract tropical curve with bounded leaves I and $h : |\Gamma|^\circ \rightarrow \mathbb{R}^m$ is a continuous map. Furthermore, if $\Gamma = (G, (I_f)_{f \in F_G})$ and q_Γ as in Definition 1.2.2, we require for flags $f \in F_G \setminus \{x_i \mid i \in I\}$ that

$$h \circ q_\Gamma|_{I_f} : I_f \rightarrow \mathbb{R}^m, \quad t \mapsto a_f + tv(f)$$

for an $a_f \in \mathbb{R}^m$ and $v(f) \in \mathbb{Z}^m$ such that

- (1) for $i \in K$ we have $v(x_i) = \delta_i$ if $i \notin I$ and $v(j_G(x_i)) = \delta_i$ if $i \in I$
- (2) for all vertices w of G with $\text{val}(w) > 1$ we have $\sum_{f \in F^w} v(f) = 0$.

It might seem unnatural to distinguish between $i \in I$ and $i \in K \setminus I$ in that way, but note that $v(f)$ always points away from the boundary point of the flag and the leaves x_i are "pointing inwards" for $i \in I$ and "outwards" otherwise, cf. to Figure 1. Note that it follows from the above conditions that for all edges $\{f_1, f_2\}$ of G we have $v(f_1) = -v(f_2)$. For every flag f we can write $v(f) = m_f u_f$, where u_f is a primitive integral vector and $m_f \in \mathbb{Z}_{\geq 0}$. We then call m_f the *weight* of the flag, respectively leaf if f is a leaf, or edge e if $e = \{f, f'\}$ for some flag f' .

For a vertex w of G with $\text{val}(w) > 1$ we call the collection $\Delta_w := (v(f))_{f \in F^w}$ the *local degree of h at w* .

Two tropical stable maps $(\Gamma, (x_i)_{i \in K}, h)$ and $(\Gamma', (x'_i)_{i \in K}, h')$ are called *isomorphic* if there is an isomorphism $\phi : (\Gamma, (x_i)_{i \in K}) \rightarrow (\Gamma', (x'_i)_{i \in K})$ of K -marked abstract tropical curves such that $h = h' \circ \phi|_{|\Gamma|^\circ}$. The leaves x_i with $\delta_i = 0$ will be called *marked points*, as their images under h are just points.

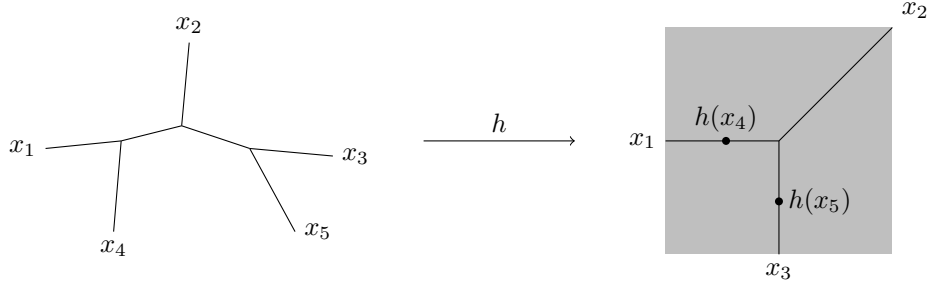

The above picture shows an example of a tropical stable map of degree $\Delta = (e_1, e_0, e_2, 0, 0)$.

Note that the above definition slightly differs from the definitions in [GKM09] or [Rau09], because those δ_i which are zero do not belong to the degree Δ there. For the purpose of this thesis it will be more convenient to treat all leaves alike, as we will cut parameterised tropical curves along bounded edges in Section 1.5. This introduces a lot more leaves and it is easier to keep track of what is going on if we consider the marked points as part of the degree.

Definition 1.2.13 (Abstract curves as abstract varieties). For an n -marked abstract tropical curve $(\Gamma, x_1, \dots, x_n)$ of genus zero we can easily equip $|\Gamma|^\circ$ from the previous definition with the structure of an abstract tropical variety. For this we define an injective tropical stable map $\iota : |\Gamma|^\circ \hookrightarrow \mathbb{R}^{n-1}$ of degree $\Delta' := (e_1, \dots, e_{n-1}, e_0)$, where e_1, \dots, e_{n-1} denotes the standard basis of \mathbb{R}^{n-1} and $e_0 := -\sum_{i=1}^{n-1} e_i$. Note that Γ and the degree Δ' already uniquely determine ι up to translations. The image $\iota(|\Gamma|^\circ) \subset \mathbb{R}^{n-1}$ is now the support of a partially open tropical variety \mathcal{X} , having weight 1 on every maximal cell. If we let U be $|\Gamma|$ without all of its vertices, and $\omega : U \rightarrow \mathbb{Q}$ constant one, we obtain an abstract tropical variety

$$(|\Gamma|^\circ, U, \omega, \iota, \mathbb{Z}^{n-1}, \mathcal{X}).$$

We also want to denote this abstract tropical variety Γ in the following, if confusion with the metric graph is unlikely. If we have another tropical stable map $h : |\Gamma|^\circ \rightarrow \mathbb{R}^m$ of degree $\Delta = (\delta_1, \dots, \delta_n)$, then $f := h \circ \iota^{-1} : \mathcal{X} \rightarrow \mathbb{R}^m$ is an affine linear tropical morphism whose linear part f_{lin} satisfies $f_{\text{lin}}(e_i) = \delta_i$ for $i = 1, \dots, n-1$ and $f_{\text{lin}}(e_0) = \delta_n$. Hence $h : \Gamma \rightarrow \mathbb{R}^m$ is a morphism of tropical varieties.

Definition 1.2.14 (The tropical moduli space ${}_I\mathcal{M}_0(\mathbb{R}^m, \Delta)$). Let ${}_I\mathcal{M}_0(\mathbb{R}^m, \Delta)$ denote the set of all isomorphism classes of tropical stable maps into \mathbb{R}^m of degree Δ , where the abstract tropical curves are K -marked, of genus zero and with bounded leaves $I \subset K$. Again we denote this space by $\mathcal{M}_0(\mathbb{R}^m, \Delta)$ if $I = \emptyset$ and by $\mathcal{M}'_0(\mathbb{R}^m, \Delta)$ if $I = K$. When we write $(\Gamma, (x_i)_{i \in K}, h) \in {}_I\mathcal{M}_0(\mathbb{R}^m, \Delta)$ we always mean the isomorphism class of $(\Gamma, (x_i)_{i \in K}, h)$.

As a next step we will first define a few maps which will then be used to define several structures of a tropical topological space on ${}_I\mathcal{M}_{0,n}(\mathbb{R}, \Delta)$. Then we will show that they are all equivalent, hence they define the same abstract tropical variety.

Definition 1.2.15 (Barycentre). Let $|K| - |I| \neq 2$ and $\mathcal{C} = (\Gamma, (x_i)_{i \in K}, h) \in {}_I\mathcal{M}_0(\mathbb{R}^m, \Delta)$. We define the *barycentre* of \mathcal{C} to be

$$B(\mathcal{C}) := \frac{1}{|K| - |I| - 2} \sum_{v \in V_{G(\Gamma)}} (\text{val}(v) - 2)h(v).$$

As two-valent vertices do not contribute to B , the definition is independent of the underlying graph of Γ . Additionally we want to define

$$\text{bc}(\mathcal{C}) := (|K| - |I| - 2)B(\mathcal{C}),$$

which we denote the *barycentre morphism* as this will turn out to be a morphism. This morphism will be quite convenient to work with when gluing curves.

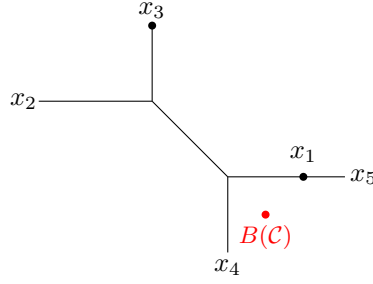

Above we see an example for the barycentre, which might look a bit misplaced at a first glance but the one-valent vertex incident to x_3 contributes with mass -1 while all other vertices contribute with mass 1 .

Definition 1.2.16 (Evaluation). For $\mathcal{C} = (\Gamma, (x_i)_{i \in K}, h) \in {}_I \mathcal{M}_0(\mathbb{R}^m, \Delta)$ with metric graph $\Gamma = (G, (I_f)_{f \in F_G})$ we can define several evaluation maps, which are in fact tropical morphisms as we will see in Construction 1.2.20. For $i \in I$ or $\delta_i = 0$ and q_Γ as in Definition 1.2.2 we define

$$\text{ev}_i(\mathcal{C}) := \lim_{I_{x_i} \ni t \rightarrow 0} h(q_\Gamma(t))$$

which is a well-defined point in \mathbb{R}^m , i.e. it does not depend on the underlying graph. We need the limit here as h is by definition not defined at the one-valent vertices. For arbitrary $i \in K$ let $U \subset \mathbb{R}^m$ be a subvector space with $\delta_i \in U$ and let $q_U : \mathbb{R}^m \rightarrow \mathbb{R}^m/U$ denote the quotient map. We define

$$\text{ev}_i^U(\mathcal{C}) := \lim_{I_{x_i} \ni t \rightarrow 0} q_U(h(q_\Gamma(t)))$$

which also does not depend on the underlying graph. We take the quotient here, as there is no canonical point on an unbounded leaf x_i whose image under h we could take, except $\partial_{G(\Gamma)}(x_i)$, but this depends on the representative of an isomorphism class of tropical stable maps and hence does not define a map on the moduli space.

Definition 1.2.17 (Forgetful maps). Let $I \subset K$ such that $|K| + |I| \geq 3$. Then we define $\text{ft} : {}_I \mathcal{M}_0(\mathbb{R}^m, \Delta) \rightarrow {}_I \mathcal{M}_{0,K}$ as $\text{ft}(\Gamma, (x_i)_{i \in K}, h) := (\Gamma, (x_i)_{i \in K})$. For $I \subset K' \subset K$ with $|K'| + |I| \geq 3$ we can furthermore define $\text{ft}_{K'} : {}_I \mathcal{M}_0(\mathbb{R}^m, \Delta) \rightarrow {}_I \mathcal{M}_{0,K'}$ as

$$\text{ft}_{K'} := \tilde{\text{ft}}_{K'} \circ \text{ft}.$$

There are also maps forgetting marked points and keeping the map h and the remaining part of the metric graph, but those will be unnecessary in this thesis and quite cumbersome to write down with our definition, as they change Δ .

Definition 1.2.18 (Forgetting the length of a bounded leaf). Let $J \subset I \subset K$ and assume that $(\tilde{q}_I^J \circ \text{ft})(\Gamma, (x_i)_{i \in K}, h) = (\tilde{\Gamma}, (x_i)_{i \in K})$. Then there is a natural isometric embedding $|\Gamma| \hookrightarrow |\tilde{\Gamma}|$ and a unique way to extend h from $|\Gamma|^\circ$ to \tilde{h} on $|\tilde{\Gamma}|^\circ$ such that $(\tilde{\Gamma}, (x_i)_{i \in K}, \tilde{h})$ is a tropical stable map. We then define

$$q_I^J : {}_I \mathcal{M}_0(\mathbb{R}^m, \Delta) \rightarrow {}_J \mathcal{M}_0(\mathbb{R}^m, \Delta), \quad (\Gamma, (x_i)_{i \in K}, h) \mapsto (\tilde{\Gamma}, (x_i)_{i \in K}, \tilde{h}),$$

which will turn out to be a tropical quotient morphism in Lemma 1.2.21. As before, we abbreviate $q_I := q_I^\emptyset$.

Definition 1.2.19 (The distance map). For any pair $i, j \in K$ we have the distance map $\text{d}_{ij} : {}_I \mathcal{M}_0(\mathbb{R}^m, \Delta) \rightarrow \mathbb{R}$ defined as $\text{d}_{ij} := \tilde{\text{d}}_{ij} \circ \text{ft}$. This will turn out to be a morphism for $i, j \in I$ because ft and $\tilde{\text{d}}_{ij}$ are morphisms then.

Construction 1.2.20 (Tropical structure of ${}_I \mathcal{M}_0(\mathbb{R}^m, \Delta)$). We will now define several embeddings of ${}_I \mathcal{M}_0(\mathbb{R}^m, \Delta)$ into $Q_{K,I} \times \mathbb{R}^m$ for $|K| + |I| \geq 3$. We define

$$\text{d}_{K,I} : {}_I \mathcal{M}_0(\mathbb{R}^m, \Delta) \rightarrow Q_{K,I}$$

as $d_{K,I} := \tilde{d}_{K,I} \circ \text{ft}$. Let $K_0 = \{i \in K \mid 0 = \delta_i \in \Delta\}$. Let $k, l \in K$ such that $\delta_k, \delta_l \in \Delta$ are linearly independent. Furthermore, let U and W be two subvector spaces defined over \mathbb{Z} with $\mathbb{R}^m = U \oplus W$ such that $\delta_k \in U$ and $\delta_l \in W$. We obtain natural isomorphisms $\psi_W : \mathbb{R}^m/W \xrightarrow{\sim} U$ and $\psi_U : \mathbb{R}^m/U \xrightarrow{\sim} W$.

Similar to [GKM09], Proposition 4.7 we obtain that each

- (1) $\Phi_B^{\Delta,I} := d_{K,I} \times B$ if $|K| - |I| - 2 \neq 0$, where B is as in Definition 1.2.15
- (2) $\Phi_i^{\Delta,I} := d_{K,I} \times \text{ev}_i$ if $i \in K_0 \cup I$
- (3) $\Phi_{kl}^{\Delta,I} := d_{K,I} \times (\psi_U \circ \text{ev}_k^U + \psi_W \circ \text{ev}_l^W)$ if $k, l \in K \setminus (K_0 \cup I)$ as above

defines an embedding ${}_I\mathcal{M}_0(\mathbb{R}^m, \Delta) \hookrightarrow Q_{K,I} \times \mathbb{R}^m$ with image ${}_I\mathcal{M}_{0,K} \times \mathbb{R}^m$. The idea is that the abstract tropical curve (i.e. the image of $d_{K,I}$) and the degree Δ already uniquely determine the map into \mathbb{R}^m up to translations. The second factor then fixes the translation.

Now we define a lattice inside $Q_{K,I} \times \mathbb{R}^m$. For this let $\Lambda^{\Delta,I} \subset {}_I\mathcal{M}_0(\mathbb{R}^m, \Delta)$ be the subset of all $(\Gamma, (x_i)_{i \in K}, h)$ with $h(v) \in \mathbb{Z}^m$ for all vertices v of $G(\Gamma)$ with $\text{val}(v) \neq 2$ and such that every pair of non-two-valent vertices of $G(\Gamma)$ has integral distance in $|\Gamma|$. Then we define

- (1) $\Lambda_B^{\Delta,I} := \left\langle \Phi_B^{\Delta,I}(\Lambda^{\Delta,I}) \right\rangle_{\mathbb{Z}}$ if $|K| - |I| - 2 \neq 0$
- (2) $\Lambda_i^{\Delta,I} := \left\langle \Phi_i^{\Delta,I}(\Lambda^{\Delta,I}) \right\rangle_{\mathbb{Z}}$ if $i \in K_0 \cup I$
- (3) $\Lambda_{kl}^{\Delta,I} := \left\langle \Phi_{kl}^{\Delta,I}(\Lambda^{\Delta,I}) \right\rangle_{\mathbb{Z}}$ if $k, l \in K \setminus (K_0 \cup I)$ as above.

In the following let $\star \in \{B, i, kl\}$. In each of the above cases ${}_I\mathcal{M}_{0,K} \times \mathbb{R}^m$ is a tropical variety in $Q_{K,I} \times \mathbb{R}^m$ with respect to the lattice $\Lambda_{\star}^{\Delta,I}$, since $(Q_{K,I} \times 0) \cap \Lambda_{\star}^{\Delta,I} = \Lambda_{K,I} \times 0$. As in Construction 1.2.9 we can now define tropical topological spaces

$$({}_I\mathcal{M}_0(\mathbb{R}^m, \Delta), U_{\star}, \omega_{\star}, \Phi_{\star}^{\Delta,I}, \Lambda_{\star}^{\Delta,I}, {}_I\mathcal{M}_{0,K} \times \mathbb{R}^m),$$

where the topology on ${}_I\mathcal{M}_0(\mathbb{R}^m, \Delta)$ is the one induced by $\Phi_{\star}^{\Delta,I}$ from the euclidean topology on $Q_{K,I} \times \mathbb{R}^m$. The open set U_{\star} is the preimage of the union of the relative interiors of the maximal cones of some polyhedral structure on ${}_I\mathcal{M}_{0,K} \times \mathbb{R}^m$ and $\omega_{\star} : U_{\star} \rightarrow \mathbb{Q}$ is constant one. It can be shown that whenever we can define two of these structures for fixed values of K, I and Δ , they are equivalent and therefore define the same abstract tropical variety. We will only prove the equivalence between $\star = i$ and $\star = B$. For $|K| \geq 3$ and $i \in K_0 \cup I$ Lemma 1.2.22 provides a linear map $b_i : Q_{K,I} \rightarrow \mathbb{R}^m$ with $b_i \circ d_{K,I} = B - \text{ev}_i$ on ${}_I\mathcal{M}_0(\mathbb{R}^m, \Delta)$. We obtain an equivalence

$$(5) \quad F_B^i := \text{id}_{Q_{K,I}} \times (b_i + \text{id}_{\mathbb{R}^m}) : Q_{K,I} \times \mathbb{R}^m \longrightarrow Q_{K,I} \times \mathbb{R}^m,$$

i.e. $\Phi_B^{\Delta,I} = F_B^i \circ \Phi_i^{\Delta,I}$, which by definition also respects the lattices. It is an isomorphism because we can easily define an inverse with $-b_i$ instead of b_i . In the case $|K| = 2$ the relation between ev_i and B is easy to see. A proof of the equivalence of $\Phi_i^{\Delta,I}$ and $\Phi_j^{\Delta,I}$ for $i, j \in K_0 \cup I$ can be found in [GKM09], Remark 4.11. The equivalence of $\Phi_B^{\Delta,I}$ or $\Phi_i^{\Delta,I}$ with $\Phi_{kl}^{\Delta,I}$ works by considering the proofs for the above cases modulo U and W .

Now we come to the case $\Delta = (\delta_1, \delta_2)$ and $I = \emptyset$. Clearly $\langle \delta_1 \rangle_{\mathbb{R}} = \langle \delta_2 \rangle_{\mathbb{R}} =: U$ and we can see that $\text{ev}_1^U = \text{ev}_2^U : \mathcal{M}_0(\mathbb{R}^m, \Delta) \rightarrow \mathbb{R}^m/U$ is a bijection. \mathbb{R}^m/U is a tropical variety equipped with lattice \mathbb{Z}^m/U and as above this information turns $\mathcal{M}_0(\mathbb{R}^m, \Delta)$ into an abstract tropical variety.

The combinatorial type of a stable map of degree Δ will be defined in Definition 1.5.1. In case of stable maps into \mathbb{R}^m this will be just the combinatorial type of the abstract tropical curve plus some (in this case) redundant data. Therefore also ${}_I\mathcal{M}_0(\mathbb{R}^m, \Delta)$ has a stratification by combinatorial types, which is just the stratification of ${}_I\mathcal{M}_{0,K}$ times \mathbb{R}^m . In the symbol ${}_I\mathcal{M}_0(\mathbb{R}^m, \Delta)$ we do not see the set which labels the abstract curves, as this is hidden in $\Delta = (\delta_i)_{i \in K} \in (\mathbb{Z}^m)^K$. For a bijection $f : K \rightarrow [N]$ there is a $\Delta' = (\delta'_j)_{1 \leq j \leq N} \in$

$(\mathbb{Z}^m)^N$ with $\delta_i = \delta'_{f(i)}$ for all $i \in K$ and a natural isomorphism between ${}_I\mathcal{M}_0(\mathbb{R}^m, \Delta)$ and ${}_{f(I)}\mathcal{M}_0(\mathbb{R}^m, \Delta')$. Thus we will not distinguish between these spaces.

After we equipped ${}_I\mathcal{M}_0(\mathbb{R}^m, \Delta)$ with the structure of an abstract tropical variety, we want to see why the maps from the previous definitions are morphisms.

For $i \in K_0 \cup I$ consider $\text{ev}_i : {}_I\mathcal{M}_0(\mathbb{R}^m, \Delta) \rightarrow \mathbb{R}^m$. Using the tropical structure given by $\Phi_i^{\Delta, I}$ it becomes just a projection onto the factor \mathbb{R}^m and it respects the lattices as $\Lambda^{\Delta, I}$ is chosen exactly in the way to make this work. Hence ev_i is a morphism. In the same way $\text{ev}_i^U : {}_I\mathcal{M}_0(\mathbb{R}^m, \Delta) \rightarrow \mathbb{R}^m/U$ for $\delta_i \in U \subset \mathbb{R}^m$ is a morphism, if we use $\Phi_{kl}^{\Delta, I}$ instead.

For $|K| - |I| - 2 \neq 0$ the map $\text{bc} : {}_I\mathcal{M}_0(\mathbb{R}^m, \Delta) \rightarrow \mathbb{R}^m$ from Definition 1.2.15 is actually a morphism. This can be seen using the tropical structure $\Phi_B^{\Delta, I}$. We need to multiply by the total mass of the curves in order to make this compatible with the lattices.

Consider $\text{ft} : {}_I\mathcal{M}_0(\mathbb{R}^m, \Delta) \rightarrow {}_I\mathcal{M}_{0, K}$ from Definition 1.2.17 which forgets about the map. If we use any tropical structure $\Phi_{\star}^{\Delta, I}$ this map just becomes a projection onto ${}_I\mathcal{M}_{0, K}$ which is compatible with the lattices. Hence ft is a morphism. This also makes $\text{ft}_{K'}$ a morphism for each $I \subset K' \subset K$ with $|K'| + |I| \geq 3$, because it is the composition of two morphisms.

As it is a little more cumbersome to write down why q_I^J from Definition 1.2.18 is a quotient morphism, we want to state this as a separate lemma.

Lemma 1.2.21. *For $J \subset I$ the map $q_I^J : {}_I\mathcal{M}_0(\mathbb{R}^m, \Delta) \rightarrow {}_J\mathcal{M}_0(\mathbb{R}^m, \Delta)$ is a quotient morphism, i.e. there is a linear surjection $q : Q_{K, I} \times \mathbb{R}^m \rightarrow Q_{K, J} \times \mathbb{R}^m$ such that $q_I^J = (\Phi_{\star}^{\Delta, J})^{-1} \circ q \circ \Phi_{\star}^{\Delta, I}$ and $q(\Lambda_{\star}^{\Delta, I}) = \Lambda_{\star}^{\Delta, J}$ for suitable tropical structures.*

PROOF. First assume $J \neq \emptyset$ and let $q := (\tilde{q}_I^J \circ \text{pr}_{Q_{N, I}}) \times \text{pr}_{\mathbb{R}^m}$. This is a linear surjection satisfying $q_I^J = (\Phi_i^{\Delta, I})^{-1} \circ q \circ \Phi_i^{\Delta, I}$. If $J = \emptyset$ and $|K| - |I| \neq 2$, we define

$$q := \left(\tilde{q}_I^J \circ \text{pr}_{Q_{N, I}} \right) \times \frac{1}{|K| - 2} \left((|K| - |I| - 2) \text{pr}_{\mathbb{R}^m} \circ \left(\text{id} + \sum_{j \in I} (F_B^j)^{-1} \right) \right)$$

where F_B^j is the linear map from (5). Also in this case we obtain a linear surjection. We have $\text{pr}_{\mathbb{R}^m} \circ \Phi_B^{\Delta, I} = B$ and $\text{pr}_{\mathbb{R}^m} \circ (F_B^j)^{-1} \circ \Phi_B^{\Delta, I} = \text{ev}_j$ and as $h(\partial_G(x_j))$ for $j \in I$ contributes with mass -1 to $B(\mathcal{C})$, we see that the expression in the second factor of q gives us $B(q_I^J(\mathcal{C}))$. So we obtain $q_I^J = (\Phi_B^{\Delta, I})^{-1} \circ q \circ \Phi_B^{\Delta, I}$. This implies the claim about the lattices using the observation $q_I^J(\Lambda^{\Delta, I}) = \Lambda^{\Delta, J}$.

If $|K| - |I| = 2$ and $J = \emptyset$, but $|K| \geq 4$ we have $|I| \geq 2$ so we can choose any $\emptyset \neq I' \subsetneq I$ and we have that $q_I = q_{I'} \circ q_{I'}^{I'}$ has all the claimed properties as a composition. For $|K| \leq 3$ there remains only one special case with $J = \emptyset$, namely $|K| = 3$ and $|I| = 1$ which is easy to describe explicitly. \square

Lemma 1.2.22. *Let $|K| - |I| - 2 \neq 0$, $|K| \geq 3$ and $\delta_i \in \Delta$ with $i \in I$ or $\delta_i = 0$. Then there is a linear map $b_i : Q_{K, I} \rightarrow \mathbb{R}^m$ such that $b_i \circ \text{d}_{K, I} = B - \text{ev}_i$ on ${}_I\mathcal{M}_0(\mathbb{R}^m, \Delta)$.*

PROOF. Without loss of generality we can assume $K = [N]$ and $i = 1$. Let $\Delta = (\delta_i)_{i \in [N]}$ and abbreviate $b_1 = b$. Consider the following minimal linearly dependent set of generators of $Q_{N, I}$:

$$(6) \quad L = \{v_S \mid S \subset [N], |S| = 2 \text{ and } 1 \notin S\} \cup \{u_i \mid i \in I\},$$

cf. [KM09], Section 2. We define b as

$$b(v_S) = \frac{1 - |S \cap I|}{N - |I| - 2} \sum_{i \in S} \delta_i \text{ for } v_S \in L, \quad b(u_i) = -\frac{1}{N - |I| - 2} \delta_i \text{ for } i \in I \setminus \{1\}$$

$$\text{and } b(u_1) = -\frac{N - |I| - 1}{N - |I| - 2} \delta_1.$$

In order to prove that this really defines a linear map, we need to check that this is compatible with the only relation

$$(7) \quad \sum_{v_S \in L} v_S = u_1 + (N - 3) \sum_{1 \neq i \in I} u_i$$

among the elements in L , cf. Lemma 2.4 in [KM09]. Recall that $u_1 = 0$ if $1 \notin I$, but then also $\delta_1 = 0$ by assumption. Let us first consider the case $1 \notin I$. We obtain

$$\begin{aligned} \sum_{v_S \in L} b(v_S) &\stackrel{\text{def.}}{=} \frac{1}{N - |I| - 2} \sum_{v_S \in L} (1 - |S \cap I|) \sum_{i \in S} \delta_i \stackrel{\text{(a)}}{=} -\frac{|I| - 1}{N - |I| - 2} \sum_{i \in I} \delta_i + \sum_{1 \neq i \notin I} \delta_i \\ &\stackrel{\text{(b)}}{=} -\frac{N - 3}{N - |I| - 2} \sum_{i \in I} \delta_i \stackrel{\text{def.}}{=} (N - 3) \sum_{1 \neq i \in I} b(u_i) \end{aligned}$$

where equality (a) is obtained by an easy computation distinguishing between the three possibilities $1 - |S \cap I| \in \{-1, 0, 1\}$ and (b) is obtained by adding $0 = \frac{|I| - 1}{N - |I| - 2} \sum_{i \in [N]} \delta_i$ and balancing. Similarly, in case $1 \in I$ we obtain

$$\begin{aligned} \sum_{v_S \in L} b(v_S) &= -\frac{|I| - 2}{N - |I| - 2} \sum_{1 \neq i \in I} \delta_i + \frac{N - |I| - 1}{N - |I| - 2} \sum_{i \notin I} \delta_i \\ &\stackrel{\text{(c)}}{=} -\frac{N - |I| - 1}{N - |I| - 2} \delta_1 - \frac{N - 3}{N - |I| - 2} \sum_{1 \neq i \in I} \delta_i \stackrel{\text{def.}}{=} b(u_1) + (N - 3) \sum_{1 \neq i \in I} b(u_i) \end{aligned}$$

where we add $-\frac{N - |I| - 1}{N - |I| - 2} \sum_{i \in [N]} \delta_i = 0$ to obtain equality (c). So we see that the definition of b is compatible with the relation (7) in each case. Therefore b can be extended from L to $Q_{N,I}$ as a linear map. We now want to compute its values on the other generators v_J of ${}_I \mathcal{M}_{0,N}$ where without any restriction $1 \notin J$. By [KM09] Lemma 2.7, we have $v_J = \sum_{v_S \in L: S \subset J} v_S - (|J| - 2) \sum_{i \in I \cap J} u_i$ and therefore

$$\begin{aligned} b(v_J) &= \sum_{v_S \in L: S \subset J} b(v_S) - (|J| - 2) \sum_{i \in I \cap J} b(u_i) \\ &= \frac{1}{N - |I| - 2} \left(-(|I \cap J| - 1) \sum_{i \in I \cap J} \delta_i + (|J \setminus I| - 1) \sum_{i \in J \setminus I} \delta_i + (|J| - 2) \sum_{i \in I \cap J} \delta_i \right) \\ &= \frac{|J \setminus I| - 1}{N - |I| - 2} \sum_{i \in J} \delta_i. \end{aligned}$$

We will prove the rest of the claim by induction on the number of non-two-valent vertices. Let $\mathcal{C} = (\Gamma, x_1, \dots, x_N, h) \in {}_I \mathcal{M}_{0,n}(\mathbb{R}^m, \Delta)$ such that $G(\Gamma)$ has no two-valent vertices and only one vertex of valency bigger than one, i.e. $|G(\Gamma)| = 1 + |I|$. Then $d_{[N],I}(\mathcal{C}) = \sum_{i \in I} \lambda_i u_i$ for some $\lambda_i > 0$. We have to distinguish between $1 \notin I$ and $1 \in I$ again. Both situations are depicted below, where the coordinates of the images of the vertices are indicated in blue and the relevant masses in red.

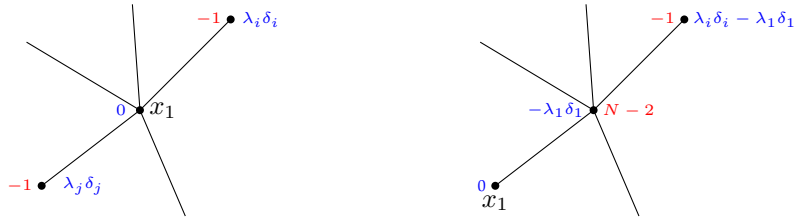

In case $1 \notin I$ we easily see that $(B - \text{ev}_1)(\mathcal{C}) = -\frac{1}{N-|I|-2} \sum_{i \in I} \lambda_i \delta_i = b(\sum_{i \in I} \lambda_i u_i)$, and a short computation shows $(B - \text{ev}_1)(\mathcal{C}) = -\lambda_1 \frac{N-|I|-1}{N-|I|-2} \delta_1 - \frac{1}{N-|I|-2} \sum_{1 \neq i \in I} \lambda_i \delta_i = b(\sum_{i \in I} \lambda_i u_i)$ in case $1 \in I$.

So now let $\mathcal{C} = (\Gamma, x_1, \dots, x_N, h)$ be a stable map such that $G(\Gamma)$ has no two-valent vertices and $|G(\Gamma)| = k + |I|$, where $k > 1$. Let v denote a vertex of $G(\Gamma)$ with $\text{val}(v) \geq 3$, which is neither incident to x_1 nor to $j_{G(\Gamma)}(x_1)$, and such that there is exactly one edge $e = \{v, v'\}$ in $G(\Gamma)$ with $\text{val}(v') > 1$. We now want to shrink the edge e to a point. Let λ be the length of e and let J be the set of leaves x_i with either $\partial_{G(\Gamma)}(x_i) = v$ or $\partial_{G(\Gamma)}(j_{G(\Gamma)}(x_i)) = v$. If we abbreviate $d_{[N],I}(\mathcal{C}) =: v_{\mathcal{C}}$, there is a representative of an isomorphism class of stable maps $\mathcal{C}' = (\Gamma', x'_1, \dots, x'_N, h') \in {}_I \mathcal{M}_0(\mathbb{R}^m, \Delta)$ with $d_{[N],I}(\mathcal{C}') = v_{\mathcal{C}} - \lambda v_J =: v_{\mathcal{C}'}$. We assume that $G(\Gamma')$ has no two-valent vertices. By the choice of v we have $\text{ev}_1(\mathcal{C}) = \text{ev}_1(\mathcal{C}')$ and by the choice of λ we have $|G(\Gamma')| = k - 1 + |I|$. By induction we can assume $(B - \text{ev}_1)(\mathcal{C}') = b(v_{\mathcal{C}'})$. We will abbreviate the mass $\omega_u = \text{val}(u) - 2$ for all vertices.

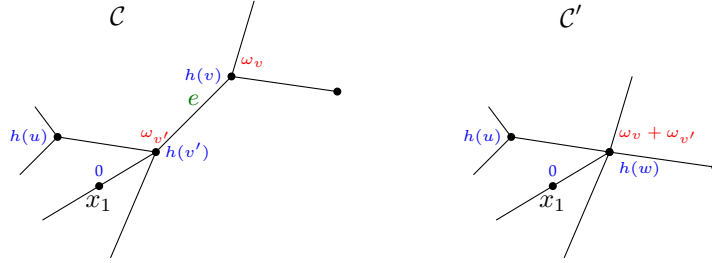

There is natural map f from the vertices of $G(\Gamma)$ to the vertices of $G(\Gamma')$ such that f is injective away from $\{v, v'\}$ and $f(\{v, v'\}) = \{w\}$ for some vertex w of $G(\Gamma')$. This is because \mathcal{C}' is obtained from \mathcal{C} by shrinking the edge e to length zero. Let T be the set of all vertices of $G(\Gamma)$ which are neither v nor adjacent to v . Then $h'(f(u)) = h(u)$ for all $u \in T$, as $\text{ev}_1(\mathcal{C}) = \text{ev}_1(\mathcal{C}')$. Shrinking the length of e to zero, the only vertices of the curve that move are v and $\partial_{G(\Gamma)}(x_i)$ for $i \in I \cap J$. To be precise, we have $h(\partial_{G(\Gamma)}(x_i)) = h'(\partial_{G(\Gamma')}(x'_i)) + \lambda \sum_{j \in J} \delta_j$ for $i \in I \cap J$. So we obtain

$$(N - |I| - 2)(B - \text{ev}_1)(\mathcal{C}) = \omega_v(h(v) - \text{ev}_1(\mathcal{C})) + \omega_{v'}(h(v') - \text{ev}_1(\mathcal{C})) \\ - \sum_{j \in I \cap J} h(\partial_{G(\Gamma)}(x_j)) - \text{ev}_1(\mathcal{C}) + \sum_{u \in T} \omega_u(h(u) - \text{ev}_1(\mathcal{C}))$$

$$\text{and } (N - |I| - 2)(B - \text{ev}_1)(\mathcal{C}') = \omega_w(h'(w) - \text{ev}_1(\mathcal{C}')) - \sum_{j \in I \cap J} (h'(\partial_{G(\Gamma')}(x'_j)) - \text{ev}_1(\mathcal{C}')) \\ + \sum_{u \in T} \omega_u(h'(f(u)) - \text{ev}_1(\mathcal{C}'))$$

where we multiplied by the total mass to make the formulas look a little nicer. Using the above formulas and also taking into account that $\omega_w = \omega_v + \omega_{v'}$, $h'(w) = h(v')$, $h(v) = h(v') + \lambda \sum_{i \in J} \delta_i$ and $\omega_v - |J \cap I| = |J \setminus I| - 1$ we can see that

$$(B - \text{ev}_1)(\mathcal{C}) - (B - \text{ev}_1)(\mathcal{C}') = \lambda \frac{|J \setminus I| - 1}{N - |I| - 2} \sum_{i \in J} \delta_i = b(\lambda v_J).$$

Thus it follows that $(B - \text{ev}_1)(\mathcal{C}) = (b \circ d_{[N],I})(\mathcal{C})$. This proves the induction step and hence the claim. \square

Remark 1.2.23. In the following chapters we will usually identify ${}_I\mathcal{M}_0(\mathbb{R}^m, \Delta)$ with its image under $\Phi_{\star}^{\Delta, I}$. This way we obtain an isomorphism ${}_I\mathcal{M}_0(\mathbb{R}^m, \Delta) \cong {}_I\mathcal{M}_{0, K} \times \mathbb{R}^m$. We will say that we have *barycentric coordinates* if $\star = B$, we have *root vertex* x_i if $\star = i$ and we have *root leaves* x_k and x_l if $\star = kl$.

We adopted the term "root vertex" from [GKM09]. As in that paper we do of course not mean that x_i is the vertex, we mean the position of the image of the vertex which is incident to the leaf x_i .

1.3. A brief review of tropical intersection theory

For convenience of the reader we will shortly recall a few definitions of the basic notions from tropical intersection theory as it is presented in [AR10], [Rau09], [Fra12] and [FR10].

Definition 1.3.1 (Tropical cycle groups and Weil divisors). If \mathcal{X} is a tropical variety in some vector space V , we denote by $Z_k(\mathcal{X})$ the group whose elements are tropical subvarieties \mathcal{Z} of \mathcal{X} with only integer weights and $\dim \mathcal{Z} = k$. Furthermore, let $[\emptyset] \in Z_k(\mathcal{X})$ which will become the zero cycle. We define the sum of $[\mathcal{Z}_1]$ and $[\mathcal{Z}_2]$ in $Z_k(\mathcal{X})$ as follows, cf. Construction 5.14 of [AR10]. There is a pure polyhedral complex \mathcal{Z} of dimension k and weight functions $\omega_1, \omega_2 : \mathcal{Z}(k) \rightarrow \mathbb{Z}$ such that $[(\mathcal{Z}, \omega_1)] = [\mathcal{Z}_1]$ and $[(\mathcal{Z}, \omega_2)] = [\mathcal{Z}_2]$. We then define $[\mathcal{Z}_1] + [\mathcal{Z}_2] := [(\mathcal{Z}, \omega_1 + \omega_2)]$. It is easy to see that this defines an abelian group structure on $Z_k(\mathcal{X})$. The elements of $Z_{\dim \mathcal{X} - 1}(\mathcal{X})$ are called *Weil divisors* on \mathcal{X} . If we allow arbitrary k -dimensional subvarieties of \mathcal{X} we denote the resulting group by $Z_k(\mathcal{X})_{\mathbb{Q}}$.

Definition 1.3.2 (Rational functions and their Weil divisors). If $\mathcal{X} \subset V = \Lambda \otimes_{\mathbb{Z}} \mathbb{R}$ is a tropical variety, a *rational function* on \mathcal{X} is a continuous piecewise affine linear function $\varphi : |\mathcal{X}| \rightarrow \mathbb{R}$, i.e. there is a polyhedral structure on \mathcal{X} such that φ is integer affine linear on cells. This means for each cell σ there is some $\varphi_{\sigma} \in \Lambda_{\sigma}^{\vee}$ and a constant $c_{\sigma} \in \mathbb{R}$ such that $\varphi|_{\sigma} = \varphi_{\sigma}|_{\sigma} + c_{\sigma}$. We call φ a *fan function* if the polyhedral complex consisting of the domains of affine linearity of φ , is an affine fan. We can associate a *Weil divisor* $\varphi \cdot \mathcal{X}$ to every rational function φ as follows: Choose a polyhedral structure such that φ is affine linear on the cells of \mathcal{X} and define

$$\varphi \cdot \mathcal{X} = \{\tau \mid \tau \notin \mathcal{X}^{(0)}\} \text{ and for } \tau \in \mathcal{X}^{(1)} :$$

$$(8) \quad \omega_{\varphi \cdot \mathcal{X}}(\tau) = \sum_{\substack{\sigma \in \mathcal{X}^{(0)} \\ \tau < \sigma}} \varphi_{\sigma}(\omega_{\mathcal{X}}(\sigma)v_{\sigma/\tau}) - \varphi_{\tau} \left(\sum_{\substack{\sigma \in \mathcal{X}^{(0)} \\ \tau < \sigma}} \omega_{\mathcal{X}}(\sigma)v_{\sigma/\tau} \right)$$

where $v_{\sigma/\tau}$ is an arbitrary preimage of the primitive integral vector $u_{\sigma/\tau}$ in Λ . Sometimes the Weil divisor is also denoted by $\text{div}(\varphi)$. The *pull back* of a rational function φ on a tropical variety along an affine integer linear morphism $f : \mathcal{X} \rightarrow \mathcal{Y}$ is given by $f^*\varphi := \varphi \circ f$, which is clearly a rational function on the tropical variety \mathcal{X} .

A function $\psi : |\mathcal{X}| \rightarrow \mathbb{R}$ which is the pointwise product of rational functions $\varphi_1, \dots, \varphi_r$ on \mathcal{X} is a *cocycle (of codimension r)*. We refer to [Fra12], Section 2.3 for a definition of cocycles. If $\psi = \varphi_1 \cdots \varphi_r$ is a codimension r cocycle, there is an intersection product $\psi \cdot \mathcal{X} := \varphi_1 \cdots \varphi_r \cdot \mathcal{X}$ which is a codimension r cycle in \mathcal{X} . Obviously, cocycles can be pulled back along morphisms. If $f : \mathcal{X} \rightarrow \mathcal{Y}$ is a morphism, we define $f^*\psi := \psi \circ f$ which is again a cocycle.

Definition 1.3.3 (Cartier divisors). A *representative of a Cartier divisor* on a tropical variety \mathcal{X} is a finite collection of pairs $(U_i, \varphi_i)_{i \in I}$, where each $U_i \subset |\mathcal{X}|$ is an open polyhedral set, such that $(U_i)_{i \in I}$ covers $|\mathcal{X}|$ and φ_i is a rational function on $\mathcal{X} \cap U_i$ such that $\varphi_i - \varphi_j$ is the restriction of an affine linear function on each connected component of $U_i \cap U_j$. Let $(V_j, \psi_j)_{j \in J}$ be another representative of a Cartier divisor. Then $(U_i, \varphi_i)_{i \in I}$ and $(V_j, \psi_j)_{j \in J}$ are called *equivalent* if $\varphi_i - \psi_j$ is the restriction of an affine integer linear function on each

connected component of $U_i \cap V_j$. A *Cartier divisor* is an equivalence class of representatives of Cartier divisors. For a Cartier divisor D with representative $(U_i, \varphi_i)_{i \in I}$ we obtain a Weil divisor $D \cdot \mathcal{X}$ as the Weil divisors $\varphi_i \cdot (\mathcal{X} \cap U_i)$ agree on $U_i \cap U_j$, because $\varphi_i - \varphi_j$ is affine integer linear there. Hence the $\varphi_i \cdot (\mathcal{X} \cap U_i)$ fit together to a Weil divisor $D \cdot \mathcal{X}$ on \mathcal{X} , which is independent of the choice of representative by the same reasons. The pull back f^*D of a Cartier divisor D along a morphism f can be constructed by locally pulling back the rational functions defining it.

The properties of cycles, rational functions, Cartier divisors and pull back which have been established in [AR10] also hold for partially open tropical varieties. The proofs are exactly the same.

Definition 1.3.4 (Push forward). If we have a morphism between closed tropical varieties $f : \mathcal{X} \rightarrow \mathcal{Y}$ we can define a *push forward*. For this we choose a suitable polyhedral structure on both varieties such that for each $\sigma \in \mathcal{X}$ we have $f(\sigma) \in \mathcal{Y}$, cf. Construction 7.3 of [AR10]. Such polyhedral structures are called *compatible with f* . Then we want to equip the polyhedral subcomplex

$$f_* \mathcal{X} := \{f(\sigma) \mid \sigma \in \mathcal{X} \text{ is contained in a maximal cell on which } f \text{ is injective}\}$$

of \mathcal{Y} with the weight function

$$\omega_{f_* \mathcal{X}}(\sigma') = \sum_{\sigma \in \mathcal{X}; f(\sigma) = \sigma'} \omega_{\mathcal{X}}(\sigma) |\Lambda'_{\sigma'} : f_{\text{lin}}(\Lambda_{\sigma})|$$

where f_{lin} denotes the linear part of f .

If \mathcal{X} is partially open and f is injective, the above definition also yields a well-defined, i.e. balanced, push forward $f_* \mathcal{X}$. Note that $f_* \mathcal{X}$ does not have to be a subvariety of \mathcal{Y} , e.g. this is not the case if we embed a bounded open interval into \mathbb{R} .

This construction might cause problems for partially open tropical varieties if we do not require f to be injective. For example, let e_1, e_2 denote the standard basis of \mathbb{R}^2 and consider $\mathcal{X} = \mathbb{R}e_1 \cup (e_2 + \mathbb{R}_{>0}e_1) \subset \mathbb{R}^2$ with weight one on every cell, $\mathcal{Y} = \mathbb{R}$ and f as projection onto $\mathbb{R}e_1 \cong \mathbb{R}$. One can see that for any choice of tropical structure on \mathcal{X} there is always one partially open cell $\sigma \in \mathcal{X}$, namely the one with $(0, 1) \in \bar{\sigma}$. Hence also $f(\sigma)$ is partially open, but all cells of every polyhedral structure on \mathbb{R} have to be closed. Thus there cannot be polyhedral structures which are compatible with f .

Properties of the push forward which have been proved in [AR10] can be proved the same way for partially open tropical varieties and injective morphisms.

Definition 1.3.5 (Canonical divisor). For a closed tropical hypersurface or curve $\mathcal{X} \subset \mathbb{R}^m$ with integer weights we want to define a canonical divisor in the following two cases.

- (1) $\dim \mathcal{X} = m - 1$, i.e. \mathcal{X} is a hypersurface. It is known, e.g. from Theorem 2.25 of [Fra11], that there is a unique Cartier divisor D with $D \cdot \mathbb{R}^m = \mathcal{X}$. If we denote the embedding $\iota := \text{id}|_{|\mathcal{X}|} : \mathcal{X} \rightarrow \mathbb{R}^m$, then we define $K_{\mathcal{X}} := \iota^*D$.
- (2) $\dim \mathcal{X} = 1$, i.e. \mathcal{X} is a curve, and let \mathcal{X} be smooth and irreducible. Choose any polyhedral structure on \mathcal{X} and equip $\mathcal{X}(0)$ with weights

$$\omega(V) := |\{\sigma \in \mathcal{X}(1) \mid V \in \sigma\}| - 2.$$

This defines a unique Weil divisor \mathcal{Z} on \mathcal{X} and as \mathcal{X} is smooth, there is a unique Cartier divisor $K_{\mathcal{X}}$ such that $K_{\mathcal{X}} \cdot \mathcal{X} = \mathcal{Z}$ by Corollary 3.8 of [Fra11].

In both cases, we call $K_{\mathcal{X}}$ the *canonical divisor* of \mathcal{X} .

In the following we will make use of the concept of rational equivalence of tropical divisors and cycles. We refer to [AR08] for details and just note that the degree of rationally equivalent zero dimensional cycles is the same. Furthermore every tropical cycle \mathcal{Z} is rationally

equivalent to a fan $\delta(\mathcal{Z})$, the *recession fan* of \mathcal{Z} which is defined in [AR08], Definition 8. The recession fan is more or less what we obtain if we shrink all bounded cells of \mathcal{Z} to a point and translate this to the origin.

Remark 1.3.6. Let $\mathcal{X} \subset \mathbb{R}^m$ be as in the previous definition. For a curve $(\Gamma, x_1, \dots, x_N, h) \in \mathcal{M}_0(\mathbb{R}^m, \Delta)$ with $h(|\Gamma|) \subset |\mathcal{X}|$ we can consider the pull back $h^*K_{\mathcal{X}}$ and the degree of $h^*K_{\mathcal{X}}.\Gamma$, which turns out to depend only on Δ and \mathcal{X} :

- (1) Let $\dim \mathcal{X} = m - 1$. Then $\deg h^*K_{\mathcal{X}}.\Gamma = \deg K_{\mathcal{X}}.h_*\Gamma$ by the projection formula. As \mathcal{X} is a hypersurface, it is cut out by a Cartier divisor D . It follows from $|h_*\Gamma| \subset |\mathcal{X}|$ that $K_{\mathcal{X}}.h_*\Gamma = D.h_*\Gamma = h_*\Gamma \cdot_{\mathbb{R}^m} \mathcal{X}$, where $\cdot_{\mathbb{R}^m}$ denotes the intersection product in \mathbb{R}^m defined in [AR10], Section 9. In order to compute the degree we can use rational equivalence and recession fans as defined in [AR08]. Theorem 12 of [AR08] yields

$$\deg h^*K_{\mathcal{X}}.\Gamma = \deg \delta(h_*\Gamma \cdot_{\mathbb{R}^m} \mathcal{X}) = \deg [\delta(h_*\Gamma) \cdot_{\mathbb{R}^m} \delta(\mathcal{X})] = \deg [\Delta \cdot_{\mathbb{R}^m} \delta(\mathcal{X})]$$

where Δ means the canonical tropical fan cycle defined by the tuple Δ . In particular, the degree $\deg h^*K_{\mathcal{X}}.\Gamma$ does not depend on our choice of the curve, only on the degree Δ and on \mathcal{X} .

- (2) Let $\dim \mathcal{X} = 1$ and let \mathcal{X} be smooth and irreducible. As \mathcal{X} is smooth, every Weil divisor is the intersection of a Cartier divisor with the curve. For the Weil divisor of a point $P \in |\mathcal{X}|$ we will denote such a Cartier divisor also by P . As \mathcal{X} is irreducible, we have $h_*\Gamma = m[\mathcal{X}]$ for some integer m . For every point $P \in |\mathcal{X}|$ we obtain $m = \deg h^*P.\Gamma$ by the projection formula, in particular this is independent of the point P . We have that $K_{\mathcal{X}}.\mathcal{X}$ is rationally equivalent to $(\deg K_{\mathcal{X}}.\mathcal{X})P$ for every point P , as on a rational curve any two points are rationally equivalent. If we choose a point P far out on an unbounded cell σ of \mathcal{X} where h is locally a cover of σ by leaves of Γ , we see that $m = \deg h^*P.\Gamma$ only depends on Δ and \mathcal{X} , therefore also $\deg h^*K_{\mathcal{X}}.\Gamma = m \deg K_{\mathcal{X}}.\mathcal{X}$ only depends on Δ and \mathcal{X} .

In the two cases above we define the number $\deg h^*K_{\mathcal{X}}.\Gamma =: K_{\mathcal{X}}.\Delta$.

Definition 1.3.7. For a tropical curve \mathcal{C} and a Cartier divisor D on \mathcal{C} we have $D.\mathcal{C} = \sum_P m_P P \in Z_0(\mathcal{C})$ and we call $(D.\mathcal{C})_P := m_P$ the local intersection multiplicity at P . In the special case where \mathcal{X} is as in (1) or (2) of the previous remark, we abbreviate $(h^*K_{\mathcal{X}}.\Gamma)_P =: (K_{\mathcal{X}}.\Delta)_P$ for $P \in |\Gamma|$.

In the following let Σ be a complete unimodular fan in \mathbb{R}^m .

Definition 1.3.8 (Minkowski weights). We want to define the group of *Minkowski weights* on Σ as

$$(9) \quad M_k(\Sigma) := \{(a_\tau)_\tau \in \mathbb{Z}^{\Sigma(k)} \mid (a_\tau)_\tau \text{ turns } \bigcup_{n \leq k} \Sigma(n) \text{ into a tropical polyhedral complex}\}$$

which is obviously a group with respect to coordinatewise addition. These groups have been introduced in [FS97] by Fulton and Sturmfels in order to study the Chow cohomology of the toric variety $X(\Sigma)$, which is the reason why we consider this here (cf. the introduction into toric geometry in Section 2.1).

Definition 1.3.9. For each ray $\rho \in \Sigma(1)$ let u_ρ denote the primitive integral vector on it. Then we can define a rational function Ψ_ρ on \mathbb{R}^m by $\Psi_\rho(u_\rho) = 1$ and $\Psi_\rho(u_{\rho'}) = 0$ for $\rho \neq \rho' \in \Sigma(1)$ and extending this linearly onto the cones of Σ . For a cone $\tau \in \Sigma$ we define the cocycle $\Psi_\tau = \prod_{\rho \in \tau(1)} \Psi_\rho$. See also Notation 2.7 in [Fra11].

Now we want to assign a Minkowski weight on Σ to every element in $Z_k(\mathbb{R}^m)$. For each tropical curve $\mathcal{C} \in Z_1(\mathbb{R}^m)$ we have that $\deg(\Psi_\rho.\mathcal{C}) = \deg(\Psi_\rho.\Delta)$, where \mathcal{C} is rationally equivalent to the fan $\Delta = \delta(\mathcal{C})$ in \mathbb{R}^m . Let $\delta_1, \dots, \delta_s$ denote the primitive integral vectors of the rays of Δ multiplied by the weight of the ray. If $\delta_j \in \sigma_j$ for some $\sigma_j \in \Sigma$, there are

unique non-negative integers α_ρ^j with $\delta_j = \sum_{\rho \in \sigma_j(1)} \alpha_\rho^j u_\rho$ since Σ is unimodular. We then define $\alpha_\rho^j = 0$ for $\rho \notin \sigma_j(1)$. Using (8) it can be seen that $\deg(\Psi_\rho \cdot \Delta) = \sum_j \alpha_\rho^j =: d_\rho$. As Δ is balanced, so is the 1-skeleton of Σ with the collection of weights $(d_\rho)_\rho$. Hence we can associate to every tropical curve $\mathcal{C} \in Z_1(\mathbb{R}^m)$ a Minkowski weight via

$$(10) \quad \mathcal{C} \mapsto [\mathcal{C}]^{M(\Sigma)} := (\deg(\Psi_\rho \cdot \mathcal{C}))_\rho \in M_1(\Sigma).$$

In this tropical picture the divisors Ψ_ρ play the role of the toric boundary divisors D_ρ . In the same way, we can associate to every k -dimensional tropical cycle $\mathcal{Z} \in Z_k(\mathbb{R}^m)$ a Minkowski weight by

$$\mathcal{Z} \mapsto [\mathcal{Z}]^{M(\Sigma)} := (\deg(\Psi_\tau \cdot \mathcal{Z}))_\tau \in M_k(\Sigma).$$

We will not prove that this actually is a Minkowski weight, as we will not need this. The idea of a proof is the following: For a common unimodular refinement of Σ and the recession fan $\delta(\mathcal{Z})$, the statement reduces to toric intersection theory.

We conclude this review of tropical intersection theory with technical lemmas concerning quotient varieties, push forward and pull back. These will be very useful later on.

Lemma 1.3.10. *Let $\mathcal{X} \subset V$ be a tropical variety with lineality space L and let $q : V \rightarrow V/L$ denote the quotient map. Then for any rational function φ on \mathcal{X}/L we have $(q^* \varphi \cdot \mathcal{X})/L = \varphi \cdot (\mathcal{X}/L)$.*

PROOF. This is obvious from the definitions. \square

Lemma 1.3.11. *Let \mathcal{X} be a tropical variety with lineality space L and let \mathcal{Y} be a tropical variety with lineality space L_2 . Let $L_1 \subset L$ be a rational subvector space and assume that we have injective morphisms f and g*

$$\mathcal{X} \xrightarrow{q_1} \mathcal{X}/L_1 \xrightarrow{f} \mathcal{Y} \xrightarrow{q_2} \mathcal{Y}/L_2 \xrightarrow{g} \mathcal{Z},$$

for a tropical variety \mathcal{Z} . Assume furthermore that also $f_*[\mathcal{X}/L_1]$ has lineality space L_2 , $\dim L = \dim L_1 + \dim L_2$ and that there is an injective morphism F with

$$\mathcal{X} \xrightarrow{Q} \mathcal{X}/L \xrightarrow{F} \mathcal{Z}$$

and $F \circ Q = g \circ q_2 \circ f \circ q_1$. Then we have

$$g_* [f_* [\mathcal{X}/L_1] / L_2] = F_* [\mathcal{X}/L].$$

PROOF. Assume that the polyhedral structures of all cycles are sufficiently fine to be compatible with all of the morphisms and the lineality spaces. Both cycles have the same dimension $\dim \mathcal{X} - \dim L = \dim \mathcal{X} - \dim L_1 - \dim L_2$, so we have to show that the weights on the maximal cells coincide. One can easily check that the linear parts of the morphisms also satisfy $F_{\text{lin}} \circ Q = g_{\text{lin}} \circ q_2 \circ f_{\text{lin}} \circ q_1$. If σ is a cell of $FQ(\mathcal{X}) = gq_2f q_1(\mathcal{X})$ of full dimension and $\rho \in \mathcal{X}$ such that $\tilde{\rho} = Q(\rho)$, $\bar{\rho} = q_1(\rho)$ and $f(\tilde{\rho}) = \tau$, $\bar{\tau} = q_2(\tau)$ and $g(\bar{\tau}) = \sigma$, we obtain

$$\begin{aligned} \omega_{F_* (\mathcal{X}/L)}(\sigma) &= \omega_{\mathcal{X}/L}(\tilde{\rho}) |\Lambda_\sigma^{\mathcal{Z}} : F_{\text{lin}}(\Lambda_{\tilde{\rho}}^{\mathcal{X}/L})| \stackrel{(a)}{=} \omega_{\mathcal{X}}(\rho) |\Lambda_\sigma^{\mathcal{Z}} : F_{\text{lin}}Q(\Lambda_\rho^{\mathcal{X}})| \\ &\stackrel{(b)}{=} \omega_{\mathcal{X}/L_1}(\bar{\rho}) |\Lambda_\tau^{\mathcal{Y}} : f_{\text{lin}}q_1(\Lambda_{\bar{\rho}}^{\mathcal{X}})| |\Lambda_\sigma^{\mathcal{Z}} : g_{\text{lin}}q_2(\Lambda_\tau^{\mathcal{Y}})| \\ &\stackrel{(c)}{=} \omega_{\mathcal{X}/L_1}(\bar{\rho}) |\Lambda_\tau^{\mathcal{Y}} : f_{\text{lin}}(\Lambda_{\bar{\rho}}^{\mathcal{X}/L_1})| |\Lambda_\sigma^{\mathcal{Z}} : g_{\text{lin}}q_2(\Lambda_\tau^{\mathcal{Y}})| \\ &= \omega_{f_* (\mathcal{X}/L_1)}(\tau) |\Lambda_\sigma^{\mathcal{Z}} : g_{\text{lin}}q_2(\Lambda_\tau^{\mathcal{Y}})| = \omega_{f_* (\mathcal{X}/L_1)/L_2}(\bar{\tau}) |\Lambda_\sigma^{\mathcal{Z}} : g_{\text{lin}}(\Lambda_{\bar{\tau}}^{\mathcal{Y}/L_2})| \\ &= \omega_{g_* (f_* (\mathcal{X}/L_1)/L_2)}(\sigma). \end{aligned}$$

Here the upper indices at the lattices shall indicate to which tropical variety they belong. Equality (a) is just the definition of the quotient lattice and the quotient variety. The same holds for equality (c). For equality (b) we need to take care of the lattice indices. We have $\Lambda_\sigma^{\mathcal{Z}} \supset g_{\text{lin}}q_2(\Lambda_\tau^{\mathcal{Y}}) \supset F_{\text{lin}}Q(\Lambda_\rho^{\mathcal{X}})$ and therefore

$$|\Lambda_\sigma^{\mathcal{Z}} : F_{\text{lin}}Q(\Lambda_\rho^{\mathcal{X}})| = |\Lambda_\sigma^{\mathcal{Z}} : g_{\text{lin}}q_2(\Lambda_\tau^{\mathcal{Y}})| |g_{\text{lin}}q_2(\Lambda_\tau^{\mathcal{Y}}) : F_{\text{lin}}Q(\Lambda_\rho^{\mathcal{X}})|.$$

We want to see that $g_{\text{lin}q_2}(\Lambda_\tau^{\mathcal{Y}})/F_{\text{lin}Q}(\Lambda_\rho^{\mathcal{X}}) \cong \Lambda_\tau^{\mathcal{Y}}/f_{\text{lin}q_1}(\Lambda_\rho^{\mathcal{X}})$, for which we have to show that $(g_{\text{lin}} \circ q_2)^{-1}(F_{\text{lin}Q}(\Lambda_\rho^{\mathcal{X}})) = f_{\text{lin}q_1}(\Lambda_\rho^{\mathcal{X}})$. But this is clear as $g_{\text{lin}q_2}f_{\text{lin}q_1}(\Lambda_\rho^{\mathcal{X}}) = F_{\text{lin}Q}(\Lambda_\rho^{\mathcal{X}})$, g_{lin} is injective and q_2 is surjective. So the claim about the isomorphism is proven and gives us equality (b). \square

1.4. Pulling back the diagonal of L_r^q

In Section 1.5 we will need to pull back the diagonal of smooth tropical fans in order to glue tropical moduli spaces. So for every smooth tropical fan \mathcal{Y} and tropical morphism $f : \mathcal{X} \rightarrow \mathcal{Y} \times \mathcal{Y}$ we want to define a cycle $f^*\Delta_{\mathcal{Y}}$ in \mathcal{X} such that $|f^*\Delta_{\mathcal{Y}}| \subset f^{-1}|\Delta_{\mathcal{Y}}|$. This is quite technical and will be the content of this section. Even though for smooth \mathcal{Y} the diagonal is a product of Cartier divisors, tropical intersection theory unfortunately does not provide a well-defined pull back for this yet, as the pull back could depend on the choice of Cartier divisors which cut out $\Delta_{\mathcal{Y}}$. The pull back cycle $f^*\Delta_{\mathcal{Y}}$ is known to be independent of the choice of Cartier divisors which cut out $\Delta_{\mathcal{Y}}$ if $\dim \mathcal{Y} = 1$ or if $\mathcal{Y} = \mathbb{R}^m$.

Definition 1.4.1 (Diagonal). For every tropical variety \mathcal{Y} , the diagonal $\Delta_{\mathcal{Y}}$ is defined as $\Delta_{\mathcal{Y}} := \iota_* \mathcal{Y}$, where $\iota : \mathcal{Y} \rightarrow \mathcal{Y} \times \mathcal{Y}$ is given by $x \mapsto (x, x)$.

First we briefly review some facts about matroids and matroid fans, the basic reference for what we will do now is [FR10]. For the precise definitions of matroids and rank functions we refer to [Oxl92]. Let us just note that a *matroid* M is a structure on a finite ground set E , which is uniquely determined by a function $r_M : 2^E \rightarrow \mathbb{Z}_{\geq 0}$ having certain properties, cf. [Oxl92] Section 1.3. Here 2^E denotes the power set of E . The function r_M is called *rank function* of M . A *flat* of M is a subset $F \subset E$ such that $r_M(F) < r_M(F \cup \{x\})$ for every $x \in E \setminus F$. Given two matroids M and M' on ground sets E and E' , we can define a matroid $M \oplus M'$ on the disjoint union $E \sqcup E'$. In terms of rank functions it is defined as $r_{M \oplus M'}(A \sqcup B) := r_M(A) + r_{M'}(B)$ for $A \subset E$ and $B \subset E'$. Note that the flats of $M \oplus M'$ are exactly the disjoint unions of flats of M and M' .

Let now M be a loopfree matroid on the ground set E , i.e. $r_M(\{x\}) = 1$ for every $x \in E$. To every flat F of M we associate a vector $e_F \in \mathbb{R}^E$ with $e_F = \sum_{i \in F} e_i$, where the e_i are the standard basis vectors. To every chain of flats $\emptyset \subsetneq F_1 \subsetneq \dots \subsetneq F_s = E$ we assign a cone, spanned by e_{F_1}, \dots, e_{F_s} and $-e_{F_s}$. Let $\mathcal{B}(M)$ denote the collection of all these cones, where the maximal ones are equipped with weight one. This is a tropical polyhedral complex called the *fine subdivision* of the *matroid variety* $\mathbb{B}(M)$, which is the tropical variety defined by $\mathcal{B}(M)$. We have $\dim \mathbb{B}(M) = r_M(E)$, which is called the *rank* of M . By definition, $\mathbb{B}(M)$ has lineality space $\mathbb{R}e_E$. Furthermore, note that $\mathbb{B}(M) \times \mathbb{B}(M') = \mathbb{B}(M \oplus M')$.

Of special interest to us is the *uniform matroid* $U_{q+1, r+1}$ on a ground set E of cardinality $q+1$ with rank function $r(A) = |A|$ if $|A| \leq r+1$ and $r(A) = r+1$ else. We are interested in this matroid because $\mathbb{B}(U_{r+1, q+1}) \cong L_r^q \times \mathbb{R}$.

In Section 4 of [FR10] it is explained how to cut out the diagonal $\Delta_{\mathbb{B}(M)}$ in $\mathbb{B}(M) \times \mathbb{B}(M)$ by a product of rational functions: If r is the rank of M , we obtain the diagonal as intersection product $\Delta_{\mathbb{B}(M)} = \varphi_1 \cdot \dots \cdot \varphi_r \cdot \mathbb{B}(M)^2$ with

$$(11) \quad \varphi_i(e_A, e_B) = \begin{cases} -1 & \text{if } r_M(A) + r_M(B) - r_M(A \cup B) \geq i \\ 0 & \text{else} \end{cases}$$

for flats A, B of M . The functions φ_i are linear on the cones of $\mathcal{B}(M \oplus M)$. Note that recursively intersecting with the φ_i yields a matroid fan in each intermediate step, hence a *locally irreducible* tropical variety. This will be important in the construction.

The following construction was suggested to me by Georges François.

Construction 1.4.2 (Pulling back the diagonal). Let $f : \mathcal{X} \rightarrow \mathcal{Y} \times \mathcal{Y}$ be a morphism to an affine smooth tropical fan \mathcal{Y} .

Let first \mathcal{Y} be closed. Then there is an isomorphism $\theta : \mathcal{Y} \times \mathbb{R} \xrightarrow{\sim} \mathbb{B}(Q) \times \mathbb{R}^m$, where $Q = U_{r+1, q+1}$ and θ maps the central cell of the coarsest polyhedral structure of \mathcal{Y} onto \mathbb{R}^m . The additional factor \mathbb{R} is introduced to deal with the lineality space of $\mathbb{B}(Q)$. Consider the following commutative diagram

$$\begin{array}{ccc} \mathcal{X} \times \mathbb{R}^2 & \xrightarrow{f \times \text{id}} & (\mathcal{Y} \times \mathbb{R}) \times (\mathcal{Y} \times \mathbb{R}) \\ & \searrow^{f_1 \times f_2} & \cong \downarrow \theta \times \theta \\ & & \mathbb{B}(Q)^2 \times (\mathbb{R}^m)^2 \end{array}$$

and let ψ_1, \dots, ψ_m cut out the diagonal in $(\mathbb{R}^m)^2$. Furthermore denote the projections by $\pi_1 : \mathbb{B}(Q)^2 \times (\mathbb{R}^m)^2 \rightarrow \mathbb{B}(Q)^2$ and $\pi_2 : \mathbb{B}(Q)^2 \times (\mathbb{R}^m)^2 \rightarrow (\mathbb{R}^m)^2$. We define a cocycle

$$\Phi_{\mathcal{Y}} := \pi_1^* \varphi_1 \cdots \pi_1^* \varphi_{r+1} \pi_2^* \psi_1 \cdots \pi_2^* \psi_m,$$

where the φ_i are the functions from (11). One can see that the cycle $(f_1 \times f_2)^* \Phi_{\mathcal{Y}} \cdot (\mathcal{X} \times \mathbb{R}^2)$ has the lineality space $L = 0 \times \Delta_{\mathbb{R}}$. So we can mod out L and then project onto \mathcal{X} by p . We then define

$$f^* \Delta_{\mathcal{Y}} := f^* \Delta_{\mathcal{Y}} \cdot \mathcal{X} := p_* [((f_1 \times f_2)^* \Phi_{\mathcal{Y}} \cdot (\mathcal{X} \times \mathbb{R}^2)) / L].$$

Note that this definition is independent of the choice of the functions ψ_i by Theorem 2.25 of [Fra11] and of the choice of θ (cf. the next lemma) but it might depend on the choice of the rational functions φ_i .

If \mathcal{Y} is any smooth affine tropical fan (not necessarily closed), it is isomorphic to a restriction of $L_r^q \times \mathbb{R}^m$ to an open polyhedral subset U of its support which intersects $0 \times \mathbb{R}^m$. In this case we restrict $\Phi_{\mathcal{Y}}$ from above to U and then proceed the same way. By the next lemma this is invariant under translations by vectors in $0 \times \mathbb{R}^m$.

The reason for choosing these functions and this somewhat unnatural construction is, that we want to ensure $|f^* \Delta_{\mathcal{Y}} \cdot \mathcal{X}| \subset f^{-1} |\Delta_{\mathcal{Y}}|$ which is not a priori clear if we choose arbitrary functions cutting out the diagonal. But this is true for the pull back of a rational function from a locally irreducible variety as in our case. This can be found in [Fra12], Lemma 3.8.13.

Note that once it is known that cycles on a matroid fan admit a well-defined pull back, our definition will coincide with this.

Lemma 1.4.3. *The cycle $f^* \Delta_{\mathcal{Y}} \cdot \mathcal{X}$ is independent of the choice of isomorphism $\mathcal{Y} \times \mathbb{R} \cong \mathbb{B}(Q) \times \mathbb{R}^m$ as long as it maps the central cell of the coarsest polyhedral structure of \mathcal{Y} onto \mathbb{R}^m .*

PROOF. Let the notation be as in Construction 1.4.2. If we choose another such isomorphism θ' which maps the central cell of the coarsest polyhedral structure of \mathcal{Y} onto \mathbb{R}^m , this induces an automorphism $\vartheta = \vartheta_1 \times \vartheta_2$ of $\mathbb{B}(Q) \times \mathbb{R}^m$. By the conditions on θ and θ' we have $\vartheta(0 \times \mathbb{R}^m) = 0 \times \mathbb{R}^m$, so $\vartheta_2|_{0 \times \mathbb{R}^m}$ induces an automorphism $\tilde{\vartheta}_2$ of \mathbb{R}^m and $\vartheta_1|_{0 \times \mathbb{R}^m} = 0$. The automorphism ϑ is affine linear, hence $\vartheta - \vartheta(0, 0)$ is linear. But as $\vartheta(0, 0) \in 0 \times \mathbb{R}^m$, we conclude that ϑ_1 is already linear, and as $\vartheta_1|_{0 \times \mathbb{R}^m} = 0$ we obtain that $\vartheta_1|_{\mathbb{B}(Q) \times 0}$ induces a linear automorphism $\tilde{\vartheta}_1$ on $\mathbb{B}(Q)$. One can check that the only possibility for this is that $\vartheta(e_j, 0) = (e_{\tau(j)}, 0)$ for some permutation τ of the ground set E of Q , so we conclude that $(\tilde{\vartheta}_1 \times \tilde{\vartheta}_2)^* \varphi_i = \varphi_i$. On the second factor also the $(\tilde{\vartheta}_2 \times \tilde{\vartheta}_2)^* \psi_i$ cut out $\Delta_{\mathbb{R}^m}$ and as already mentioned the pull back from \mathbb{R}^m is independent of the choice of functions. Hence we conclude that also θ' leads to the same cycle $f^* \Delta_{\mathcal{Y}} \cdot \mathcal{X}$. \square

Lemma 1.4.4 (Lineality space). *Let $f : \mathcal{X} \rightarrow \mathcal{Y} \times \mathcal{Y}$ be a morphism and \mathcal{Y} an affine smooth tropical fan. Let σ be a central cell of \mathcal{Y} , such that a lineality space L of \mathcal{X} gets mapped into it, i.e. $f(L) \subset \Delta_\sigma \subset \sigma \times \sigma$ (where f also denotes the extension of f to an affine integer linear map on the ambient vector spaces). Then L is a lineality space of $f^* \Delta_{\mathcal{Y}}$.*

PROOF. Let the notation be as in Construction 1.4.2 and assume without loss of generality that $\mathcal{Y} \cong L_r^q \times \mathbb{R}^m$ is closed. Let L_Q denote the maximal lineality space of the matroid variety $B(Q)$, then $\theta(\sigma \times \mathbb{R}) \subset L_Q \times \mathbb{R}^m$. So for an affine linear extension of $f_1 \times f_2$ to the ambient vector spaces, we have

$$(f_1 \times f_2)(L \times \Delta_{\mathbb{R}}) \subset \Delta_{L_Q} \times \Delta_{\mathbb{R}^m}.$$

We are free to choose functions ψ_i cutting out the diagonal on \mathbb{R}^m , so we take for example $\psi_i = \min(x_i - y_i, 0)$ where x and y are the coordinates in the two copies of \mathbb{R}^m . These functions are fan functions, such that $\Delta_{\mathbb{R}^m}$ is contained in the central cell of the fan consisting of the domains of affine linearity of ψ_i . Therefore $(f_1 \times f_2)^* \pi_2^* \psi_i$ is a fan function, such that $L \times \Delta_{\mathbb{R}}$ is contained in the central cell of the fan consisting of the domains of affine linearity. Similar arguments apply to the functions φ_i from (11), which are also fan functions, and $\Delta_{L_Q} = \mathbb{R}(e_E, e_E)$. Therefore $(f_1 \times f_2)^* \Phi_{\mathcal{Y}} \cdot (\mathcal{X} \times \mathbb{R}^2)$ has $L \times \Delta_{\mathbb{R}}$ as a lineality space. The quotient by $0 \times \Delta_{\mathbb{R}}$ and push forward along p make this become a lineality space L . \square

In the following four proofs we will for simplicity assume that for a smooth affine tropical fan \mathcal{Y} we have $\mathcal{Y} \times \mathbb{R} = B(Q) \times \mathbb{R}^m$, where $Q = U_{q+1, r+1}$. Replacing $\Phi_{\mathcal{Y}}$ by $(\theta \times \theta)^* \Phi_{\mathcal{Y}}$ and restricting to an open polyhedral subset of the support will then always yield the general case.

Lemma 1.4.5 (Projection formula). *Let \mathcal{Y} be a smooth affine tropical fan, $g : \mathcal{Z} \rightarrow \mathcal{X}$ an injective morphism and $f : \mathcal{X} \rightarrow \mathcal{Y} \times \mathcal{Y}$ a morphism. Then*

$$g_* [(f \circ g)^* \Delta_{\mathcal{Y}} \cdot \mathcal{Z}] = f^* \Delta_{\mathcal{Y}} \cdot g_*(\mathcal{Z}).$$

PROOF. Denote the ambient vector space of \mathcal{Z} by V_1 and of \mathcal{X} by V_2 . Let $L_i = 0 \times \Delta_{\mathbb{R}} \subset V_i \times \mathbb{R}^2$ for $i = 1, 2$ and $\Phi_{\mathcal{Y}}$ be as in Construction 1.4.2. We denote the quotient maps $q_i : V_i \times \mathbb{R}^2 \rightarrow (V_i \times \mathbb{R}^2)/L_i$ and the projections by $p_i : (V_i \times \mathbb{R}^2)/L_i \rightarrow V_i$ for $i = 1, 2$. The morphism $g \times \text{id} : \mathcal{Z} \times \mathbb{R}^2 \rightarrow \mathcal{X} \times \mathbb{R}^2$ obviously factors as $q_2 \circ (g \times \text{id}) = \tilde{g} \circ q_1$. Applying Lemma 1.3.11 to the morphisms $\tilde{g} \circ q_1 = \text{id} \circ q_2 \circ (g \times \text{id}) \circ \text{id}$ we obtain

$$\begin{aligned} & \tilde{g}_* [(((f \circ g) \times \text{id})^* \Phi_{\mathcal{Y}} \cdot (\mathcal{Z} \times \mathbb{R}^2)) / L_1] \\ &= [(g \times \text{id})_* (((f \circ g) \times \text{id})^* \Phi_{\mathcal{Y}} \cdot (\mathcal{Z} \times \mathbb{R}^2)) / L_2] \\ &\stackrel{(a)}{=} [(f \times \text{id})^* \Phi_{\mathcal{Y}} \cdot (g_*(\mathcal{Z}) \times \mathbb{R}^2)] / L_2 \end{aligned}$$

where (a) holds by the projection formula for cocycles, cf. [Fra11], Proposition 2.24 (3). Furthermore we have $g \circ p_1 = p_2 \circ \tilde{g}$ and by definition

$$\begin{aligned} & g_* [(f \circ g)^* \Delta_{\mathcal{Y}} \cdot \mathcal{Z}] \\ &= g_* [(p_1)_* [(((f \circ g) \times \text{id})^* \Phi_{\mathcal{Y}} \cdot (\mathcal{Z} \times \mathbb{R}^2)) / L_1]] \\ &= (g \circ p_1)_* [(((f \circ g) \times \text{id})^* \Phi_{\mathcal{Y}} \cdot (\mathcal{Z} \times \mathbb{R}^2)) / L_1] \\ &= (p_2 \circ \tilde{g})_* [(((f \circ g) \times \text{id})^* \Phi_{\mathcal{Y}} \cdot (\mathcal{Z} \times \mathbb{R}^2)) / L_1] \\ &= (p_2)_* [\tilde{g}_* [(((f \circ g) \times \text{id})^* \Phi_{\mathcal{Y}} \cdot (\mathcal{Z} \times \mathbb{R}^2)) / L_1]] \\ &= (p_2)_* [((f \times \text{id})^* \Phi_{\mathcal{Y}} \cdot (g_*(\mathcal{Z}) \times \mathbb{R}^2)) / L_2] \\ &\stackrel{\text{def.}}{=} f^* \Delta_{\mathcal{Y}} \cdot g_*(\mathcal{Z}). \end{aligned}$$

\square

Lemma 1.4.6 (Commutativity). *If \mathcal{Y} and \mathcal{Z} are smooth affine tropical fans and $f: \mathcal{X} \rightarrow \mathcal{Y} \times \mathcal{Y}$ and $g: \mathcal{X} \rightarrow \mathcal{Z} \times \mathcal{Z}$ are morphisms, then*

$$f^* \Delta_{\mathcal{Y}} \cdot [g^* \Delta_{\mathcal{Z}} \cdot \mathcal{X}] = g^* \Delta_{\mathcal{Z}} \cdot [f^* \Delta_{\mathcal{Y}} \cdot \mathcal{X}].$$

PROOF. Let $\Phi_{\mathcal{Y}}$ and $\Phi_{\mathcal{Z}}$ be as in Construction 1.4.2, let $V_f = \mathbb{R}^2 = V_g$ and denote the projection $\text{pr}_f: \mathcal{X} \times V_g \times V_f \rightarrow \mathcal{X} \times V_f$. Furthermore let id_f denote the identity on V_f and let Δ_f denote the diagonal inside V_f . Similarly, we define pr_g , id_g and Δ_g . Then

$$\mathcal{C} := \text{pr}_f^*(f \times \text{id}_f)^* \Phi_{\mathcal{Y}} \cdot [\mathcal{X} \times V_f \times V_g] = [(f \times \text{id}_f)^* \Phi_{\mathcal{Y}} \cdot [\mathcal{X} \times V_f]] \times V_g$$

by Proposition 2.24 (4) of [Fra11].

If we denote $L_f := 0 \times \Delta_f \times 0$, there is a canonical isomorphism

$$\psi: (\mathcal{X} \times V_f \times V_g) / L_f \rightarrow (\mathcal{X} \times V_f) / (0 \times \Delta_f) \times V_g.$$

Using this isomorphism we obtain that

$$\psi_*(\mathcal{C} / L_f) = [((f \times \text{id}_f)^* \Phi_{\mathcal{Y}} \cdot [\mathcal{X} \times V_f]) / (0 \times \Delta_f)] \times V_g.$$

If we denote by $p_f: (\mathcal{X} \times V_f) / (0 \times \Delta_f) \rightarrow \mathcal{X}$ the projection, then push forward under $p_f \times \text{id}_g$ yields $(f^* \Delta_{\mathcal{Y}} \cdot \mathcal{X}) \times V_g$ by definition. Hence

$$(p_f \times \text{id}_g)_* \psi_*(\mathcal{C} / L_f) = (f^* \Delta_{\mathcal{Y}} \cdot \mathcal{X}) \times V_g.$$

Now we intersect both sides with $(g \times \text{id}_g)^* \Phi_{\mathcal{Z}}$ and apply the projection formula for cocycles twice on the left hand side, once for ψ and once for $p_f \times \text{id}_g$. For this we abbreviate $\Psi := \psi^*(p_f \times \text{id}_g)^*(g \times \text{id}_g)^* \Phi_{\mathcal{Z}}$ and we obtain

$$(p_f \times \text{id}_g)_* \psi_*[\Psi \cdot (\mathcal{C} / L_f)] = (g \times \text{id}_g)^* \Phi_{\mathcal{Z}} \cdot [(f^* \Delta_{\mathcal{Y}} \cdot \mathcal{X}) \times V_g].$$

If we denote the quotient map $q_{L_f}: \mathcal{X} \times V_f \times V_g \rightarrow (\mathcal{X} \times V_f \times V_g) / L_f$, we obtain $\text{pr}_g = (p_f \times \text{id}_g) \circ \psi \circ q_{L_f}$. Using this and Lemma 1.3.10, we obtain

$$(12) \quad (p_f \times \text{id}_g)_* \psi_*[(\text{pr}_g^*(g \times \text{id}_g)^* \Phi_{\mathcal{Z}} \cdot \mathcal{C}) / L_f] = (g \times \text{id}_g)^* \Phi_{\mathcal{Z}} \cdot [(f^* \Delta_{\mathcal{Y}} \cdot \mathcal{X}) \times V_g].$$

We want to abbreviate $\mathcal{C}' := \text{pr}_g^*(g \times \text{id}_g)^* \Phi_{\mathcal{Z}} \cdot \mathcal{C}$ and let

$$q_g: (g \times \text{id}_g)^* \Phi_{\mathcal{Z}} \cdot [(f^* \Delta_{\mathcal{Y}} \cdot \mathcal{X}) \times V_g] \rightarrow [(g \times \text{id}_g)^* \Phi_{\mathcal{Z}} \cdot [(f^* \Delta_{\mathcal{Y}} \cdot \mathcal{X}) \times V_g]] / (0 \times \Delta_g)$$

and $Q: \mathcal{C}' \rightarrow \mathcal{C}' / (0 \times \Delta_f \times \Delta_g)$ denote the quotient maps. Furthermore, let

$$p_g: (\mathcal{X} \times V_g) / (0 \times \Delta_g) \rightarrow \mathcal{X} \quad \text{and} \quad P: (\mathcal{X} \times V_f \times V_g) / (0 \times \Delta_f \times \Delta_g) \rightarrow \mathcal{X}$$

be the obvious projection maps. Applying Lemma 1.3.11 to the cycle \mathcal{C}' and the morphisms $P \circ Q = p_g \circ q_g \circ ((p_f \times \text{id}_g) \circ \psi) \circ q_{L_f}$ together with equation (12) yields

$$\begin{aligned} P_* \left[\left(\text{pr}_g^*(g \times \text{id}_g)^* \Phi_{\mathcal{Z}} \cdot \text{pr}_f^*(f \times \text{id}_f)^* \Phi_{\mathcal{Y}} \cdot [\mathcal{X} \times V_f \times V_g] \right) / (0 \times \Delta_f \times \Delta_g) \right] \\ = g^* \Delta_{\mathcal{Z}} \cdot [f^* \Delta_{\mathcal{Y}} \cdot \mathcal{X}]. \end{aligned}$$

On the left hand side the product of cocycles commutes. Then repeating all the above computations with f and g swapped shows that the expression on the left hand side also equals $f^* \Delta_{\mathcal{Y}} \cdot [g^* \Delta_{\mathcal{Z}} \cdot \mathcal{X}]$. \square

Lemma 1.4.7 (Quotients). *Let \mathcal{X} be a tropical variety with a lineality space L , \mathcal{Y} a smooth affine tropical fan and $f: \mathcal{X} / L \rightarrow \mathcal{Y} \times \mathcal{Y}$ be a morphism. Then*

$$q[(f \circ q)^* \Delta_{\mathcal{Y}} \cdot \mathcal{X}] = f^* \Delta_{\mathcal{Y}} \cdot [\mathcal{X} / L],$$

where $q: \mathcal{X} \rightarrow \mathcal{X} / L$ denotes the quotient map.

PROOF. Let $\Phi_{\mathcal{Y}}$ be as in Construction 1.4.2. Let $q_L : \mathcal{X} \times \mathbb{R}^2 \rightarrow (\mathcal{X} \times \mathbb{R}^2)/(0 \times \Delta_{\mathbb{R}})$ and $\bar{q}_L : \mathcal{X}/L \times \mathbb{R}^2 \rightarrow (\mathcal{X}/L \times \mathbb{R}^2)/(0 \times \Delta_{\mathbb{R}})$ denote the quotient maps and denote the projections by $p : (\mathcal{X} \times \mathbb{R}^2)/(0 \times \Delta_{\mathbb{R}}) \rightarrow \mathcal{X}$ and $\bar{p} : (\mathcal{X}/L \times \mathbb{R}^2)/(0 \times \Delta_{\mathbb{R}}) \rightarrow \mathcal{X}/L$. If we abbreviate $Q = \bar{q}_L \circ (q \times \text{id})$, we obtain

$$\begin{aligned} & q[(f \circ q)^* \Delta_{\mathcal{Y}} \cdot \mathcal{X}] \\ & \stackrel{\text{def.}}{=} q[p_* (q_L (((f \circ q) \times \text{id})^* \Phi_{\mathcal{Y}} \cdot (\mathcal{X} \times \mathbb{R}^2)))] \\ & \stackrel{(a)}{=} \bar{p}_* [Q [((f \circ q) \times \text{id})^* \Phi_{\mathcal{Y}} \cdot (\mathcal{X} \times \mathbb{R}^2)]] \\ & = \bar{p}_* [\bar{q}_L [(q \times \text{id}) [((f \circ q) \times \text{id})^* \Phi_{\mathcal{Y}} \cdot (\mathcal{X} \times \mathbb{R}^2)]]] \\ & \stackrel{(b)}{=} \bar{p}_* [\bar{q}_L [(f \times \text{id})^* \Phi_{\mathcal{Y}} \cdot (\mathcal{X}/L \times \mathbb{R}^2)]] \\ & \stackrel{\text{def.}}{=} f^* \Delta_{\mathcal{Y}} \cdot [\mathcal{X}/L]. \end{aligned}$$

Equality (a) is an application of Lemma 1.3.11 to $\text{id}_{\mathcal{X}/L} \circ q \circ p \circ q_L = \bar{p} \circ Q$ and equality (b) is an application of Lemma 1.3.10 to $q \times \text{id}$. \square

Lemma 1.4.8. *Let \mathcal{X} and \mathcal{Y} be tropical varieties, let $\text{pr} : \mathcal{X} \times \mathcal{Y} \rightarrow \mathcal{X}$ denote the projection and let $f : \mathcal{X} \rightarrow \mathcal{Z} \times \mathcal{Z}$ be a morphism, where \mathcal{Z} is a smooth affine tropical fan. Then*

$$(f \circ \text{pr})^* \Delta_{\mathcal{Z}} \cdot (\mathcal{X} \times \mathcal{Y}) = (f^* \Delta_{\mathcal{Z}} \cdot \mathcal{X}) \times \mathcal{Y}.$$

PROOF. Let $\Phi_{\mathcal{Z}}$ be as in Construction 1.4.2. Let $q_1 : \mathcal{X} \times \mathbb{R}^2 \rightarrow (\mathcal{X} \times \mathbb{R}^2)/(0 \times \Delta_{\mathbb{R}})$ and $q_2 : \mathcal{X} \times \mathcal{Y} \times \mathbb{R}^2 \rightarrow (\mathcal{X} \times \mathcal{Y} \times \mathbb{R}^2)/(0 \times 0 \times \Delta_{\mathbb{R}})$ denote the quotient maps. Furthermore let $p_1 : (\mathcal{X} \times \mathbb{R}^2)/(0 \times \Delta_{\mathbb{R}}) \rightarrow \mathcal{X}$ and $p_2 : (\mathcal{X} \times \mathcal{Y} \times \mathbb{R}^2)/(0 \times 0 \times \Delta_{\mathbb{R}}) \rightarrow \mathcal{X} \times \mathcal{Y}$ be the projections.

These maps satisfy $(p_1 \times \text{id}_{\mathcal{Y}}) \circ (q_1 \times \text{id}_{\mathcal{Y}}) = p_2 \circ q_2$. Furthermore the map $\text{pr} \times \text{id}_{\mathbb{R}^2}$ is a projection, satisfying $(f \circ \text{pr}) \times \text{id}_{\mathbb{R}^2} = (f \times \text{id}_{\mathbb{R}^2}) \circ (\text{pr} \times \text{id}_{\mathbb{R}^2})$. We obtain

$$\begin{aligned} & (f \circ \text{pr})^* \Delta_{\mathcal{Z}} \cdot (\mathcal{X} \times \mathcal{Y}) \\ & \stackrel{\text{def.}}{=} (p_2)_* q_2 [((f \circ \text{pr}) \times \text{id}_{\mathbb{R}^2})^* \Phi_{\mathcal{Z}} \cdot (\mathcal{X} \times \mathcal{Y} \times \mathbb{R}^2)] \\ & \stackrel{(a)}{=} (p_2)_* q_2 [[(f \times \text{id}_{\mathbb{R}^2})^* \Phi_{\mathcal{Z}} \cdot (\mathcal{X} \times \mathbb{R}^2)] \times \mathcal{Y}] \\ & \stackrel{(b)}{=} (p_1 \times \text{id}_{\mathcal{Y}})_* (q_1 \times \text{id}_{\mathcal{Y}}) [[(f \times \text{id}_{\mathbb{R}^2})^* \Phi_{\mathcal{Z}} \cdot (\mathcal{X} \times \mathbb{R}^2)] \times \mathcal{Y}] \\ & = (p_1)_* q_1 [(f \times \text{id}_{\mathbb{R}^2})^* \Phi_{\mathcal{Z}} \cdot (\mathcal{X} \times \mathbb{R}^2)] \times \mathcal{Y} \\ & \stackrel{\text{def.}}{=} (f^* \Delta_{\mathcal{Z}} \cdot \mathcal{X}) \times \mathcal{Y}, \end{aligned}$$

where equality (a) follows from Proposition 2.24 (4) of [Fra11] and equality (b) is an application of Lemma 1.3.11 for $(p_1 \times \text{id}_{\mathcal{Y}}) \circ (q_1 \times \text{id}_{\mathcal{Y}}) = \text{id} \circ \text{id} \circ p_2 \circ q_2$. \square

Lemma 1.4.9. *Let \mathcal{X}_1 and \mathcal{X}_2 be tropical varieties and let \mathcal{Y} be a smooth affine tropical fan. Furthermore let $f : \mathcal{X}_1 \rightarrow \mathcal{Y} \times \mathcal{Y}$ and $g : \mathcal{X}_2 \rightarrow \mathbb{R}^k \times \mathbb{R}^k$ be two morphisms. Then*

$$(f \times g)^* \Delta_{\mathcal{Y} \times \mathbb{R}^k} \cdot (\mathcal{X}_1 \times \mathcal{X}_2) = (f^* \Delta_{\mathcal{Y}} \cdot \mathcal{X}_1) \times (g^* \Delta_{\mathbb{R}^k} \cdot \mathcal{X}_2).$$

PROOF. Without loss of generality we can assume that \mathcal{Y} is closed. Then the morphism $f \times \text{id} : \mathcal{X}_1 \times \mathbb{R}^2 \rightarrow \mathcal{Y}^2 \times \mathbb{R}^2$ induces a morphism $f_1 \times f_2 : \mathcal{X}_1 \times \mathbb{R}^2 \rightarrow \text{B}(Q)^2 \times (\mathbb{R}^m)^2$ as in Construction 1.4.2. Let also $\Phi_{\mathcal{Y}}$ be as in that construction. Let the rational functions ψ'_1, \dots, ψ'_k cut out the diagonal $\Delta_{\mathbb{R}^k}$ in $(\mathbb{R}^k)^2$. As mentioned in Construction 1.4.2, we have $g^* \Delta_{\mathbb{R}^k} \cdot \mathcal{X}_2 = g^* \psi'_1 \cdots g^* \psi'_k \cdot \mathcal{X}_2$. Let $L_1 = 0 \times \Delta_{\mathbb{R}}$, let $q_1 : \mathcal{X}_1 \times \mathbb{R}^2 \rightarrow (\mathcal{X}_1 \times \mathbb{R}^2)/L_1$ denote the quotient map and let $p^{(1)} : (\mathcal{X}_1 \times \mathbb{R}^2)/L_1 \rightarrow \mathcal{X}_1$ be the projection. Furthermore let $L_2 = 0 \times 0 \times \Delta_{\mathbb{R}}$, let $q_2 : \mathcal{X}_1 \times \mathcal{X}_2 \times \mathbb{R}^2 \rightarrow (\mathcal{X}_1 \times \mathcal{X}_2 \times \mathbb{R}^2)/L_2$ denote the quotient map and

let $p^{(2)} : (\mathcal{X}_1 \times \mathcal{X}_2 \times \mathbb{R}^2)/L_2 \rightarrow \mathcal{X}_1 \times \mathcal{X}_2$ be the projection. Finally, denote the projection from $\mathcal{X}_1 \times \mathcal{X}_2 \times \mathbb{R}^2$ onto $\mathcal{X}_1 \times \mathbb{R}^2$ by pr_1 and the projection onto \mathcal{X}_2 by pr_2 . We then obtain

$$\begin{aligned} & (f^* \Delta_{\mathcal{Y}} \cdot \mathcal{X}_1) \times (g^* \Delta_{\mathbb{R}^k} \cdot \mathcal{X}_2) \\ & \stackrel{\text{def}}{=} p_*^{(1)} [((f_1 \times f_2)^* \Phi_{\mathcal{Y}} \cdot (\mathcal{X}_1 \times \mathbb{R}^2)) / L_1] \times (g^* \psi'_1 \cdots g^* \psi'_k \cdot \mathcal{X}_2) \\ & \stackrel{(a)}{=} p_*^{(2)} [((f_1 \times f_2)^* \Phi_{\mathcal{Y}} \cdot (\mathcal{X}_1 \times \mathbb{R}^2)) \times (g^* \psi'_1 \cdots g^* \psi'_k \cdot \mathcal{X}_2) / L_2] \\ & \stackrel{(b)}{=} p_*^{(2)} [\text{pr}_1^* (f_1 \times f_2)^* \Phi_{\mathcal{Y}} \cdot \text{pr}_2^* g^* \psi'_1 \cdots \text{pr}_2^* g^* \psi'_k \cdot (\mathcal{X}_1 \times \mathcal{X}_2 \times \mathbb{R}^2)] / L_2] \\ & = (f \times g)^* \Delta_{\mathcal{Y} \times \mathbb{R}^k} \cdot (\mathcal{X}_1 \times \mathcal{X}_2). \end{aligned}$$

Equality (a) is Lemma 1.3.11 applied to $(p_1 \times \text{id}_{\mathcal{X}_2}) \circ (q_1 \times \text{id}_{\mathcal{X}_2}) = p_2 \circ q_2 \circ \text{id} \circ \text{id}$ and equality (b) is Proposition 2.24 (4) of [Fra11]. The last equality follows from the definition of the pull back of the diagonal in Construction 1.4.2 and the fact that this is independent of the choice of rational functions that cut out the diagonal in $(\mathbb{R}^m \times \mathbb{R}^k)^2$. \square

Let \mathcal{Y} be a smooth affine tropical fan that has a coarsest polyhedral structure with the following property: There is an embedding $\iota : \mathcal{Y} \hookrightarrow L_r^q \times \mathbb{R}^m$ such that for every $\tau \in L_k^n \times \mathbb{R}^m$ (in the coarsest polyhedral structure), there is a unique $\sigma \in \mathcal{Y}$ with $\iota(\sigma^\circ) \subset \tau^\circ$. The particular example we have in mind is $\mathcal{X} \cap \mathcal{X}(\sigma)$, for a closed smooth tropical variety \mathcal{X} , equipped with its coarsest polyhedral structure and $\sigma \in \mathcal{X}$. If we have a morphism $f : \mathcal{X} \rightarrow \mathcal{Y} \times \mathcal{Y}$, Construction 1.4.2 provides a pull back cycle $f^* \Delta_{\mathcal{Y}} \cdot \mathcal{X}$. For every cone $\sigma \in \mathcal{Y}$ we can also consider the restriction $\mathcal{Y}_\sigma := \mathcal{Y} \cap \mathcal{Y}(\sigma)$, which is also a smooth affine tropical fan. Therefore Construction 1.4.2 also provides a pull back cycle $f^* \Delta_{\mathcal{Y}_\sigma} \cdot [\mathcal{X} \cap f^{-1} | \mathcal{Y}_\sigma^2]$ and we can ask for the relation between these two cycles.

Corollary 1.4.10. *Let \mathcal{Y} be as above and let $f : \mathcal{X} \rightarrow \mathcal{Y} \times \mathcal{Y}$ be a morphism. Then for any $\sigma \in \mathcal{Y}$ there exists a neighbourhood \mathcal{F} of σ° in \mathcal{Y} such that*

$$(f^* \Delta_{\mathcal{Y}} \cdot \mathcal{X}) \cap f^{-1} | \mathcal{F}^2 = f^* \Delta_{\mathcal{F}} \cdot [\mathcal{X} \cap f^{-1} | \mathcal{F}^2]$$

and σ° is a central cell of \mathcal{F} . Note that \mathcal{F} will in general be "smaller" than \mathcal{Y}_σ from above, cf. Example 1.4.12.

We postpone the proof to the end of this section. In the following let Q be the uniform matroid $U_{r+1, q+1}$ on the ground set E and let $R \subset E$ be of cardinality $m \leq r$. Let $U \subset |\mathcal{B}(Q)|$ be the complement of the union over all maximal cones of $\mathcal{B}(Q)$ which have a generator e_F for which $F \not\subset R$ and $R \not\subset F$. We want to define a partially open smooth affine tropical fan $\mathcal{F} := \mathcal{B}(Q) \cap U$. Note that $|\mathcal{F}|$ is also contained in $|\mathcal{B}(Q/R)| \times \mathbb{R}^R \subset \mathbb{R}^{E \setminus R} \times \mathbb{R}^R = \mathbb{R}^E$, where Q/R denotes the contraction of Q by R . Q/R is a matroid on $E \setminus R$ and its rank function is defined as $r_{Q/R}(A) := r_Q(A \cup R) - r_Q(R)$ for $A \subset E \setminus R$, in terms of the rank function of Q . Let φ_i , $i = 1, \dots, r+1$, denote the functions from (11) which cut out the diagonal in $\mathcal{B}(Q)^2$ and let $\tilde{\varphi}_i$, $i = 1, \dots, r+1-m$, be the functions cutting out the diagonal in $\mathcal{B}(Q/R)^2$. Denote the projections $\pi_{E \setminus R} : \mathcal{B}(Q/R)^2 \times (\mathbb{R}^R)^2 \rightarrow \mathcal{B}(Q/R)^2$ and $\pi_R : \mathcal{B}(Q/R)^2 \times (\mathbb{R}^R)^2 \rightarrow (\mathbb{R}^R)^2$.

Lemma 1.4.11. *With the notation from above we have $\varphi_i|_{\mathcal{F}^2} = \pi_{E \setminus R}^* \tilde{\varphi}_{i-m}|_{\mathcal{F}^2}$ for $i > m$ and $\varphi_i|_{\mathcal{F}^2} = \pi_R^* \psi_i|_{\mathcal{F}^2}$ for $i \leq m$, where the ψ_i are rational functions on $\mathbb{R}^R \times \mathbb{R}^R$ cutting out the diagonal.*

PROOF. Recall that $r_{Q/R}(A) = r_Q(A \cup R) - r_Q(R)$ for $A \subset E \setminus R$. In particular $r_{Q/R}(A) = r_Q(A)$ for $A \subset E \setminus R$ with $|A| < r+1-m$ and $r_{Q/R}(A) = r_{Q/R}(E \setminus R) = r_Q(E) - m$ else. So $Q/R \cong U_{r+1-m, q+1-m}$. We want to abbreviate

$$\mathcal{R}_Q(A, B) := r_Q(A) + r_Q(B) - r_Q(A \cup B)$$

for $A, B \subset E$ and similarly $\mathcal{R}_{Q/R}(A, B)$ for $A, B \subset E \setminus R$ with $r_{Q/R}$ instead of r_Q (cf. the definition of φ_i and $\tilde{\varphi}_i$ in (11)). After a few simple computations, we obtain that

$$(13) \quad \mathcal{R}_{Q/R}(A, B) = \mathcal{R}_Q(A \cup R, B \cup R) - m \text{ for all flats } A, B \text{ of } Q/R.$$

The support of the tropical fan \mathcal{F} is a common subset of $|\mathcal{B}(Q/R)| \times \mathbb{R}^R$ and $|\mathcal{B}(Q)|$. We want to denote the generators of $\mathcal{B}(Q/R)$ by $f_A \in \mathbb{R}^{E \setminus R}$ for flats A of Q/R and the standard basis of \mathbb{R}^R by $(l_i)_{i \in R}$. Let $l_S = \sum_{i \in S} l_i$ for $S \subset R$.

In the following let A and B be flats in Q/R . Let now $i > m$ and note that $\mathcal{R}_Q(R, R) = m$. From (13) we directly obtain

$$\varphi_i(e_{A \cup R}, e_{B \cup R}) = \tilde{\varphi}_{i-m}(f_A, f_B) = \pi_{E \setminus R}^* \tilde{\varphi}_{i-m}(e_{A \cup R}, e_{B \cup R}).$$

Furthermore $\mathcal{R}_Q(S_1, S_2) = |S_1 \cap S_2| \leq m$ for $S_1, S_2 \subset R$, hence

$$\varphi_i(e_{S_1}, e_{S_2}) = 0 = \tilde{\varphi}_{i-m}(0, 0) = \pi_{E \setminus R}^* \tilde{\varphi}_{i-m}(e_{S_1}, e_{S_2}),$$

which proves the claim for $i > m$.

Every $2m$ -dimensional cone σ of $\mathcal{B}(Q \oplus Q)$ that is contained in $(0 \times \mathbb{R}^R)^2$, contains the ray $\mathbb{R}_{\geq 0}(e_R, e_R)$. Furthermore, the cones $\sigma + \mathbb{R}(e_R, e_R)$ cover the whole of $(0 \times \mathbb{R}^R)^2$. So we can linearly (for each domain of linearity) extend the restriction of φ_i onto $|\mathcal{B}(Q)^2| \cap (0 \times \mathbb{R}^R)^2$ to a rational function $\tilde{\psi}_i$ on $(0 \times \mathbb{R}^R)^2$, for $i = 1, \dots, m$. Clearly $\tilde{\psi}_i$ induces a rational function on $\mathbb{R}^R \times \mathbb{R}^R$ with lineality space $\mathbb{R}(l_R, l_R)$.

If $i \leq m$ we obtain

$$\varphi_i(e_{A \cup R}, e_{B \cup R}) = -1 = \varphi_i(e_R, e_R) \stackrel{\text{def.}}{=} \psi_i(l_R, l_R) = \pi_R^* \psi_i(e_{A \cup R}, e_{B \cup R})$$

for all flats A, B of Q/R , because by (13) we have $\mathcal{R}_{Q/R}(A, B) + m = \mathcal{R}_Q(A \cup R, B \cup R)$ and $\mathcal{R}_{Q/R}(A, B) \geq 0$. For $S_1, S_2 \subset R$ we obtain

$$\varphi_i(e_{S_1}, e_{S_2}) \stackrel{\text{def.}}{=} \psi_i(l_{S_1}, l_{S_2}) = \pi_R^* \psi_i(e_{S_1}, e_{S_2}).$$

We know that $\Delta_{\mathcal{B}(Q)} = \varphi_1 \cdots \varphi_{r+1} \cdot \mathcal{B}(Q)^2$ by Corollary 4.2 of [FR10] and we have

$$\pi_R^* \psi_1 \cdots \pi_R^* \psi_m \cdot \pi_{E \setminus R}^* \tilde{\varphi}_1 \cdots \pi_{E \setminus R}^* \tilde{\varphi}_{q+1-m} \cdot [\mathcal{B}(Q/R)^2 \times (\mathbb{R}^R)^2] = \Delta_{\mathcal{B}(Q/R)} \times \mathcal{Z}$$

where \mathcal{Z} is the cycle cut out by the functions ψ_i . Restricting the above intersection products to \mathcal{F}^2 we obtain $(\Delta_{\mathcal{B}(Q/R)} \times \mathcal{Z}) \cap \mathcal{F}^2 = \Delta_{\mathcal{F}}$ by the computations from above. As the ψ_i have lineality space $\mathbb{R}(l_R, l_R)$, so has the cycle \mathcal{Z} . Therefore \mathcal{Z} is already uniquely determined by $\mathcal{Z} \cap (\mathbb{R}_{\geq 0}^R)^2 = \Delta_{\mathbb{R}_{\geq 0}^R}$. Hence we conclude that $\mathcal{Z} = \Delta_{\mathbb{R}^R}$, which completes the proof. \square

PROOF OF COROLLARY 1.4.10. Without loss of generality we assume that $\mathcal{Y} = L_r^q \times \mathbb{R}^m$. Let $E = \{1, \dots, q+1\}$ and let $(e'_i)_{i=1, \dots, q}$ denote the standard basis of \mathbb{R}^q , $(l_i)_{i=1, \dots, m}$ a basis of \mathbb{R}^m , e the standard basis of \mathbb{R} and $(e_i)_{i \in E}$ denotes the standard basis in \mathbb{R}^E . Then we can explicitly give the isomorphism $\theta : \mathcal{Y} \times \mathbb{R} \xrightarrow{\sim} \mathcal{B}(Q) \times \mathbb{R}^m$ as $\theta(e'_i, 0, 0) = (e_i, 0)$ for $i = 1, \dots, q$, $\theta(0, l_i, 0) = (0, l_i)$ for $i = 1, \dots, m$ and $\theta(0, 0, e) = (e_E, 0)$.

If $\dim \sigma = k + m$, we can assume that $\sigma = \{\sum_{i=1}^k \lambda_i e'_i \mid \lambda_i \in \mathbb{R}_{\geq 0} \text{ for } i = 1, \dots, k\} \times \mathbb{R}^m$ in $\mathcal{Y} \times \mathbb{R}$ and define $R = \{1, \dots, k\}$. Then $\theta(\sigma \times 0)$ intersects several cones of the fine subdivision of the matroid variety. Let $\overline{\mathcal{F}} := \mathcal{F} \times \mathbb{R}^m$, where \mathcal{F} is the tropical fan from the previous lemma. We can use the projection $\text{pr} : \mathcal{Y} \times \mathbb{R} \rightarrow \mathcal{Y}$ to obtain a neighbourhood $\mathcal{F}' = \mathcal{Y} \cap (\text{pr} \circ \theta^{-1})|\overline{\mathcal{F}}|$ of σ° in \mathcal{Y} . By definition of \mathcal{F} we have $\theta_*(\mathcal{F}' \times \mathbb{R}) = \overline{\mathcal{F}}$. In Construction 1.4.2 the cycle $f^* \Delta_{\mathcal{Y}}$ is defined via the pull back

$$(14) \quad (f \times \text{id})^*(\pi_1^* \varphi_1 \cdots \pi_1^* \varphi_r \pi_2^* \psi_1 \cdots \pi_2^* \psi_m)$$

where $\pi_1 : \mathcal{B}(Q)^2 \times (\mathbb{R}^m)^2 \rightarrow \mathcal{B}(Q)^2$ and $\pi_2 : \mathcal{B}(Q)^2 \times (\mathbb{R}^m)^2 \rightarrow (\mathbb{R}^m)^2$ denote the projections, the φ_i are the functions from (11) and ψ_1, \dots, ψ_m cut out the diagonal of $(\mathbb{R}^m)^2$.

Furthermore, as $|\mathcal{F}| \subset |\mathbb{B}(Q/R)| \times \mathbb{R}^R$ and $\theta_*(\mathcal{F}' \times \mathbb{R}) = \overline{\mathcal{F}} = \mathcal{F} \times \mathbb{R}^m$, Construction 1.4.2 defines $f^* \Delta_{\mathcal{F}'}$ via the pull back

$$(15) \quad (f \times \text{id})^* (\tilde{\pi}_1^* \tilde{\varphi}_1 \cdots \tilde{\pi}_1^* \tilde{\varphi}_{r-k} \tilde{\pi}_2^* \tilde{\psi}_1 \cdots \tilde{\pi}_2^* \tilde{\psi}_{m+k})$$

where the $\tilde{\varphi}_i$ are the functions from (11) for Q/R , the $\tilde{\psi}_i$ cut out the diagonal of $(\mathbb{R}^R \times \mathbb{R}^m)^2$ and

$$\tilde{\pi}_1 : \mathbb{B}(Q/R)^2 \times (\mathbb{R}^R)^2 \times (\mathbb{R}^m)^2 \longrightarrow \mathbb{B}(Q/R)^2 \text{ and}$$

$$\tilde{\pi}_2 : \mathbb{B}(Q/R)^2 \times (\mathbb{R}^R)^2 \times (\mathbb{R}^m)^2 \longrightarrow (\mathbb{R}^R)^2 \times (\mathbb{R}^m)^2$$

denote the projections. If we denote the projection $\pi : (\mathbb{R}^R)^2 \times (\mathbb{R}^m)^2 \longrightarrow (\mathbb{R}^m)^2$, we can assume without loss of generality that $\tilde{\psi}_i = \pi^* \psi_i$ for $i = 1, \dots, m$, as Construction 1.4.2 is independent of the choice of these functions. Applying Lemma 1.4.11 to $\pi_1^* \varphi_1 \cdots \pi_1^* \varphi_r$ we see that (14) and (15) coincide on $\overline{\mathcal{F}}^2$, for a suitable choice of $\tilde{\psi}_{m+1}, \dots, \tilde{\psi}_{m+k}$, but $f^* \Delta_{\mathcal{F}'}$ does not depend on this choice. \square

Example 1.4.12. The picture below illustrates the situation from Corollary 1.4.10. Here \mathcal{Y} is the grey fan, the cone σ is indicated in red. The blue fan is a fan for which the corollary holds, and its right boundary is coming from the fine subdivision of the matroid variety $\mathbb{B}(U_{3,4})$.

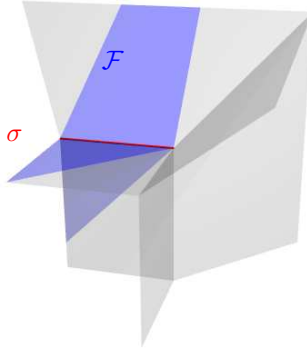

1.5. Gluing moduli spaces

In this section we want to define a polyhedral complex $\mathcal{M}_0(\mathcal{X}, \Delta)$ of degree Δ tropical stable maps whose image lies in a smooth and closed tropical curve or hypersurface $\mathcal{X} \subset \mathbb{R}^m$. We will describe how to equip this complex with weights which make it a tropical polyhedral complex. Unfortunately this is only possible under certain local assumptions on the tropical stable maps until now. However, we can prove that these local assumptions are true in the case where \mathcal{X} is a curve and also for tropical lines in surfaces in \mathbb{R}^3 later on in Chapter 3. Throughout this section let \mathcal{X} be always *closed* and let the abstract tropical curves of stable maps in $\mathcal{M}_0(\mathbb{R}^m, \Delta)$ be always N -marked.

Definition 1.5.1 (Curves in \mathcal{X} and their combinatorial types). Let \mathcal{X} be a tropical polyhedral complex. A tropical stable map $(\Gamma', x'_1, \dots, x'_N, h') \in \mathcal{M}_0(\mathbb{R}^m, \Delta)$ with $h'(|\Gamma'|) \subset |\mathcal{X}|$ is called a *curve in \mathcal{X} (of degree Δ)*. Assume that $|\Delta| > 2$ or that there is no $\sigma \in \mathcal{X}$ with $h'(|\Gamma'|) \subset \sigma$. Then $(\Gamma', x'_1, \dots, x'_N, h')$ is isomorphic (as stable map) to a curve $(\Gamma^{\mathcal{X}}, x_1, \dots, x_N, h)$ in \mathcal{X} such that

- (1) if $h^{-1}(\sigma)$ is discrete for some $\sigma \in \mathcal{X}$, it is a subset of the vertices of $\Gamma^{\mathcal{X}}$
- (2) if v is a two-valent vertex of $\Gamma^{\mathcal{X}}$, there is a cell $\sigma \in \mathcal{X}$ such that $h^{-1}(\sigma)$ is discrete and $v \in h^{-1}(\sigma)$.

If $|\Delta| = 2$ and $h'(|\Gamma'|) \subset \sigma$ for some $\sigma \in \mathcal{X}$, then $(\Gamma', x'_1, \dots, x'_N, h')$ is isomorphic (as stable map) to a curve $(\Gamma^\mathcal{X}, x_1, \dots, x_N, h)$ in \mathcal{X} such that $G(\Gamma^\mathcal{X})$ has exactly one two-valent vertex.

The picture below shows an example for Γ' and $\Gamma^\mathcal{X}$ in the case of $\mathcal{X} = L_2^3$.

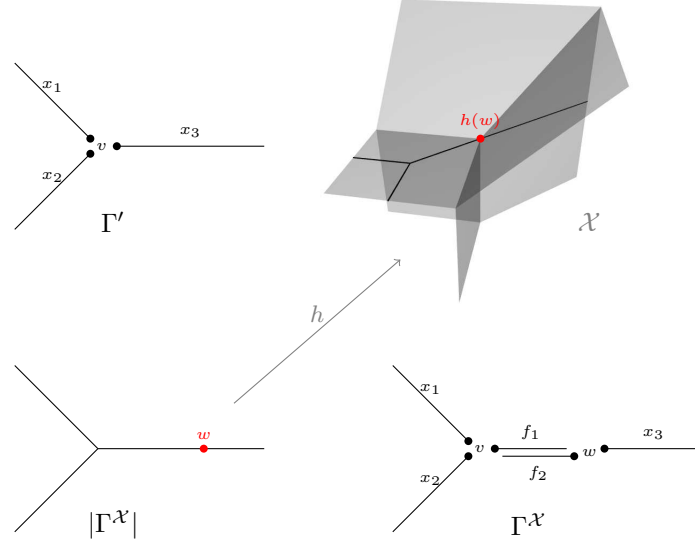

We now want to define combinatorial types of curves in \mathcal{X} . Consider tuples

$$\alpha_i := (G_i, ((\delta_f^{(i)})_{f \in \partial_{G_i}^{-1}(v)}, \sigma_v^{(i)})_{v \in V_{G_i}}) \text{ for } i = 1, 2,$$

where G_i is an N -labelled graph, $\delta_f^{(i)} \in \mathbb{Z}^m$ and $\sigma_v^{(i)} \in \mathcal{X}$. Then α_1 and α_2 are called *equivalent* if there is an isomorphism (ϕ_V, ϕ_F) of N -labelled graphs from G_1 to G_2 such that $\delta_{\phi_F(f)}^{(2)} = \delta_f^{(1)}$ and $\sigma_{\phi_V(v)}^{(2)} = \sigma_v^{(1)}$ holds for all $v \in V_{G_1}$ and $f \in F_{G_1}$.

For a stable map $(\Gamma^\mathcal{X}, x_1, \dots, x_N, h)$ as above, each vertex v of $\Gamma^\mathcal{X}$ is mapped into the relative interior of a unique cell $\sigma_v \in \mathcal{X}$. Let Δ_v be the local degree of h at v , cf. Definition 1.2.12. We call the equivalence class of $(G(\Gamma^\mathcal{X}), (\Delta_v, \sigma_v)_{v \in V_{G(\Gamma^\mathcal{X})}})$ in the sense from above the *combinatorial type* of $(\Gamma^\mathcal{X}, x_1, \dots, x_N, h)$ as curve in \mathcal{X} . As for K -marked abstract tropical curves, we define that curves in \mathcal{X} which are *isomorphic as stable maps*, have the same combinatorial type. In particular this defines a combinatorial type for curves in $\mathcal{M}_0(\mathbb{R}^m, \Delta)$ if $\mathcal{X} = \mathbb{R}^m$.

A *combinatorial type of degree Δ curves in \mathcal{X}* is an equivalence class α from above for which there exists a degree Δ tropical stable map $(\Gamma, x_1, \dots, x_N, h)$, which is of combinatorial type α . In the following we will usually write $\alpha = (G, (\Delta_v, \sigma_v)_{v \in V_G})$, when we mean that α is the equivalence class of $(G, (\Delta_v, \sigma_v)_{v \in V_G})$.

If α is a combinatorial type of degree Δ curves in \mathcal{X} , it will be convenient to talk about *vertices*, *flags*, *edges* and *leaves* of α in order to have a uniform way of addressing these objects in tropical curves which look "similar". We fix an element $(G, (\Delta_v, \sigma_v)_{v \in V_G})$ in α , for which G obviously has vertices, flags, edges and leaves. We define $V_\alpha := V_G$, $F_\alpha := F_G$ and $E_\alpha := E_G$. If $(\Gamma', x'_1, \dots, x'_N, h')$ is a curve in \mathcal{X} of combinatorial type α , it is isomorphic to a stable map $(\Gamma^\mathcal{X}, x_1, \dots, x_N, h)$ as above, via some isometric isomorphism $\phi : |\Gamma'| \xrightarrow{\sim} |\Gamma^\mathcal{X}|$. Each vertex $v \in V_\alpha$ gets identified with a vertex v' of $G(\Gamma^\mathcal{X})$. We want to address the vertex v' , its image in $|\Gamma^\mathcal{X}|$ and also $\phi^{-1}(v')$ in $|\Gamma'|$ by v . In the same way, a flag $f \in F_\alpha$ is identified with a flag f' of $G(\Gamma^\mathcal{X})$. We will address f' , its image in $|\Gamma^\mathcal{X}|$ and the preimage in $|\Gamma'|$ under ϕ by f . We do the same for edges and leaves. Note that since edges and flags of metric graphs are open by Definition 1.2.2, we conclude that for every combinatorial type α and $f \in F_\alpha$, there is a unique cell σ_f such that h maps f into σ_f° for every curve $(\Gamma, x_1, \dots, x_N, h)$

of combinatorial type α . If f is part of an edge $e = \{f, f'\} \in E_\alpha$, the same of course also holds for e .

If \mathcal{X} is an affine fan with central cell σ , we have a *trivial combinatorial type* of degree Δ curves in \mathcal{X} . The trivial combinatorial type is given by (the class of) $(G, (\Delta, \sigma))$, where G is a graph having one vertex and $|\Delta|$ flags incident to it.

Definition 1.5.2 (Cells and resolutions). We denote by $M_{\Delta, \mathcal{X}} \subset |\mathcal{M}_0(\mathbb{R}^m, \Delta)|$ the set of all curves in \mathcal{X} of degree Δ . Let $\mathcal{M}(\alpha)$ denote the set of all curves in \mathcal{X} of degree Δ of combinatorial type α , which is a partially open polyhedron inside $M_{\Delta, \mathcal{X}}$ without any proper faces. We call $\dim \mathcal{M}(\alpha)$ the *geometric dimension* of α . The closures $\overline{\mathcal{M}(\alpha)}$ equip $M_{\Delta, \mathcal{X}}$ with the structure of a polyhedral complex $\mathcal{M}_{\Delta, \mathcal{X}}$.

Furthermore we want to write $\beta \geq \alpha$ for two combinatorial types of degree Δ curves in \mathcal{X} if $\overline{\mathcal{M}(\beta)} \supset \mathcal{M}(\alpha)$ and we want to call β a *resolution* of α if $\beta \geq \alpha$ and $\beta \neq \alpha$. Furthermore we define $\mathcal{N}_{\Delta, \mathcal{X}}(\alpha) := \bigcup_{\alpha \leq \beta} \mathcal{M}(\beta)$.

For the quotient map $q_{[N]} : \mathcal{M}'_0(\mathbb{R}^m, \Delta) \rightarrow \mathcal{M}_0(\mathbb{R}^m, \Delta)$ which forgets the length of all leaves (cf. Definition 1.2.18), we want to define $\mathcal{M}'(\alpha) := q_{[N]}^{-1}(\mathcal{M}(\alpha))$ and $\mathcal{N}'_{\Delta, \mathcal{X}}(\alpha) := q_{[N]}^{-1}(\mathcal{N}_{\Delta, \mathcal{X}}(\alpha))$.

Definition 1.5.3 (Vertex type and vertex resolutions). Consider tuples $(\mathcal{X}, \delta_1, \dots, \delta_s)$ where $\mathcal{X} \subset V = \Lambda \otimes_{\mathbb{Z}} \mathbb{R}$ is a closed affine tropical fan such that its translation $\mathcal{X} + P$ by some P is a tropical fan, and $\delta_1, \dots, \delta_s \in (|\mathcal{X}| + P) \cap \Lambda$. We say two such tuples $(\mathcal{X}, \delta_1, \dots, \delta_s)$ and $(\mathcal{X}', \delta'_1, \dots, \delta'_s)$, are equivalent if there is an isomorphism $f : \mathcal{X} \xrightarrow{\sim} \mathcal{X}'$, whose linear part f_{lin} satisfies $f_{\text{lin}}(\delta_i) = \delta'_i$ for $1 \leq i \leq s$. An equivalence class of such tuples is called a *vertex type*. When we say that $(\mathcal{X}, \delta_1, \dots, \delta_s)$ is a vertex type, we actually mean the equivalence class $[(\mathcal{X}, \delta_1, \dots, \delta_s)]$.

Let \mathcal{X} be a tropical polyhedral complex, let $\alpha = (G, (\Delta_v, \sigma_v)_{v \in V_G})$ be a combinatorial type of degree Δ curves in \mathcal{X} and let v be a vertex of α . Let $P \in \sigma_v^\circ$ and consider the closed affine fan

$$(16) \quad \mathcal{X}_v := \{\mathbb{R}_{\geq 0}(\sigma - P) + P \mid \sigma \in \mathcal{X} \text{ with } \sigma \geq \sigma_v\}.$$

Furthermore, let a maximal $\mathbb{R}_{\geq 0}(\sigma - P) + P$ inherit the weight $\omega_{\mathcal{X}}(\sigma)$. This turns \mathcal{X}_v into a tropical polyhedral complex. By construction we have $\mathcal{X}_v \cap \mathcal{X}(\sigma_v) = \mathcal{X} \cap \mathcal{X}(\sigma_v)$. We then say that v is of vertex type $[v] := (\mathcal{X}_v, \Delta_v)$. A combinatorial type γ of degree Δ_v curves in \mathcal{X}_v is called a *resolution of v* . Note that we do *not* require it to be non-trivial, as otherwise Construction 1.5.5 would not yield resolutions of vertices.

Construction 1.5.4 (Cutting edges of graphs). Let G be a graph and $E \subset E_G$ a collection of edges of G . We now want to "cut" the graph G along the edges in E . Define the graph $H := (V_H, F_H, j_H, \partial_H)$ where $V_H := V_G$, $F_H := F_G$, $\partial_H := \partial_G$ but $j_H(f) := f$ if there is some other flag f' with $\{f, f'\} \in E$ and $j_H(f) := j_G(f)$ else. The collection of connected components of H is denoted $\mathcal{G}(G, E)$.

Construction 1.5.5 (Cutting combinatorial types). Let \mathcal{X} be a tropical polyhedral complex and $\beta = (G_\beta, (\Delta_v, \sigma_v)_{v \in V_{G_\beta}})$ be a combinatorial type of degree Δ curves in \mathcal{X} . Choose a subset $E \subset E_{G_\beta}$ of edges and let $\mathcal{G}(G_\beta, E) = \{G_1, \dots, G_r\}$. Assume furthermore that for each $i = 1, \dots, r$ there is some cell $\sigma_i \in \mathcal{X}$ such that $\sigma_v \geq \sigma_i$ for all $v \in V_{G_i}$. In this case let \mathcal{X}_i be the affine fan defined exactly as \mathcal{X}_v in (16), but with v replaced by i . For the cell $\sigma_v \in \mathcal{X}$ we then denote the unique cell in \mathcal{X}_i corresponding to it by $\hat{\sigma}_v$. We then call the $\beta_i := (G_i, (\Delta_v, \hat{\sigma}_v)_{v \in V_{G_i}})$ for $i = 1, \dots, r$ the *pieces of β obtained by cutting the edges in E* . The piece β_i is a combinatorial type of curves in \mathcal{X}_i .

Let $\alpha = (G_\alpha, (\Delta_w, \sigma_w)_{w \in V_{G_\alpha}})$ be another combinatorial type of degree Δ curves in \mathcal{X} such that $\beta \geq \alpha$. There is a natural inclusion of the sets of edges $E_{G_\alpha} \hookrightarrow E_{G_\beta}$, as the length of an edge of β is linear on $\overline{\mathcal{M}(\beta)}$ and hence might become zero on the face $\overline{\mathcal{M}(\alpha)}$. If we cut

β along E_{G_α} , the pieces will be in bijection to the vertices v of α and we will denote them by β_v . To check the condition about the fan from above, note that for any vertex w of β that is also a vertex of β_v , the position $h(w) \in \mathbb{R}^m$ is linear on $\overline{\mathcal{M}(\beta)}$ and it equals $h(v)$ on the face $\overline{\mathcal{M}(\alpha)}$. As $h(w) \in \sigma_w^\circ$ for each curve in $\mathcal{M}(\beta)$ and $h(v) \in \sigma_v^\circ$ for the curves in $\mathcal{M}(\alpha)$, we conclude that $\sigma_w \geq \sigma_v$.

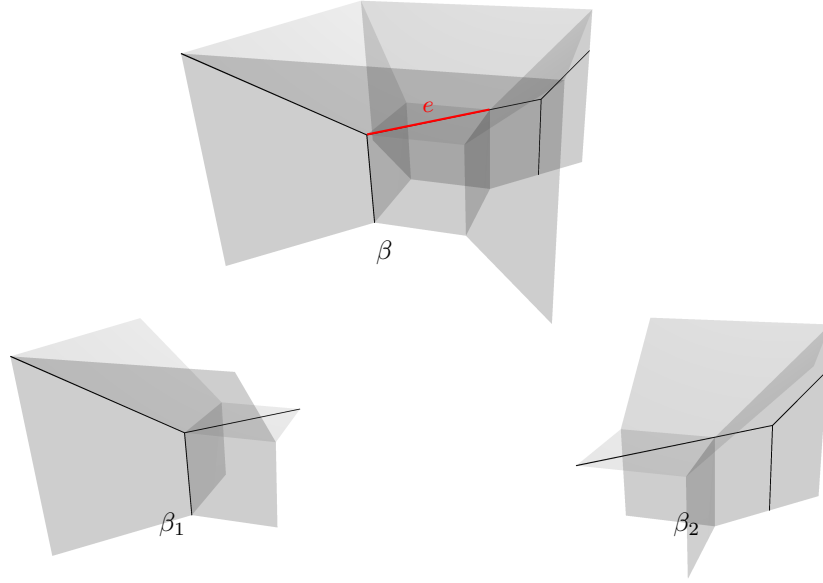

The picture above shows an example for a combinatorial type which gets cut along the red edge e into two pieces β_1 and β_2 .

Definition 1.5.6. First let \mathcal{X} be a tropical polyhedral complex which is an affine fan and either a hypersurface or a curve. For any vertex type (\mathcal{X}, Δ) we want to define the *virtual dimension* as

$$\text{vdim}(\mathcal{X}, \Delta) := |\Delta| - K_{\mathcal{X}} \cdot \Delta + \dim \mathcal{X} - 3.$$

The virtual dimension is the expected dimension of the corresponding algebraic moduli space, cf. Section 2.3.

For a vertex type $[(\mathcal{X}, \Delta)] = [(L_r^q \times \mathbb{R}^m, \Delta')]$, so $\dim \mathcal{X} = 1$ or $q - 1 = r$, we want to define the *resolution dimension* as the number

$$\text{rdim}(\mathcal{X}, \Delta) := |\Delta| - K_{\mathcal{X}} \cdot \Delta + r - 3.$$

Furthermore we define the *classification number* of the vertex type as

$$N_{[(\mathcal{X}, \Delta)]} := |\Delta| + K_{\mathcal{X}} \cdot \Delta + r.$$

Note that the polyhedral complex $\mathcal{M}_{\Delta', L_r^q \times \mathbb{R}^m}$ has an m -dimensional lineality space consisting of the curves of trivial combinatorial type. As $\text{rdim}(\mathcal{X}, \Delta) = \text{vdim}(\mathcal{X}, \Delta) - m$, the resolution dimension measures "how many" resolutions the trivial combinatorial type has. The classification number is just a tool for inductive proofs in this context, cf. the next lemma.

Now let \mathcal{X} be a smooth tropical hypersurface or curve equipped with its unique coarsest polyhedral structure. For a vertex v of a combinatorial type α of degree Δ curves in \mathcal{X} , we want to write $\text{vdim}(v) := \text{vdim}([v])$, $\text{rdim}(v) := \text{rdim}([v])$ and $N_v := N_{[v]}$.

Lemma 1.5.7. *Let \mathcal{X} be a smooth affine tropical fan equipped with its unique coarsest polyhedral structure. Let τ be the trivial combinatorial type of degree Δ curves in \mathcal{X} and w its unique vertex. Then for any resolution α of τ and any vertex v of α we have $N_w > N_v$.*

PROOF. First note that $K_{\mathcal{X}} \cdot \Delta = (K_{\mathcal{X}} \cdot \Delta)_w = \sum_v (K_{\mathcal{X}} \cdot \Delta)_v$, where the sum runs over all vertices v of α . As the local intersection multiplicity at v is always a non-negative integer in this case, we conclude that $(K_{\mathcal{X}} \cdot \Delta)_w \geq (K_{\mathcal{X}} \cdot \Delta)_v$ holds for all vertices v of α . Furthermore, if $\text{val}(v) = 2$ we must have $(K_{\mathcal{X}} \cdot \Delta)_v > 0$. For a vertex v that is mapped into the relative interior of a cone σ_v , the number r from the definition of the classification number is just $r_v = \dim \mathcal{X} - \dim \sigma_v$. And as σ_w is the central cell of \mathcal{X} , i.e. the unique cell of \mathcal{X} of smallest dimension, we conclude $r_w \geq r_v$ for all vertices v of α .

Let v be a vertex of α with $\text{val}(v) < \text{val}(w)$. By the above considerations we conclude $N_v < N_w$.

Now assume that there is a vertex v of α with $\text{val}(w) = \text{val}(v)$. Then all other vertices u of α must satisfy $\text{val}(u) = 2$. Furthermore, we have $\Delta_w = \Delta_v$ for the local degrees. If additionally $r_v = r_w$, we must have $\sigma_v = \sigma_w$ and we conclude $K_{\mathcal{X}} \cdot \Delta = (K_{\mathcal{X}} \cdot \Delta)_w = (K_{\mathcal{X}} \cdot \Delta)_v$. This means $(K_{\mathcal{X}} \cdot \Delta)_u = 0$ for the two-valent vertices of α , which is impossible. If there are no two-valent vertices, we must have $\alpha = \tau$, which is also a contradiction. We conclude $r_v < r_w$ and hence $N_v < N_w$. \square

For the rest of this section let now $\mathcal{X} \subset \mathbb{R}^m$ be a smooth tropical hypersurface or curve equipped with its unique *coarsest* polyhedral structure, except in Lemma 1.5.16. Note that we only restrict to curves and hypersurfaces here, because these are the only cases where we defined a canonical divisor. However for "obvious" generalisations of the canonical divisor to arbitrary smooth tropical varieties, we cannot show that for a curve $(\Gamma, x_1, \dots, x_N, h)$ in \mathcal{X} the degree of the pull back $\deg h^* K_{\mathcal{X}} \cdot \Gamma$ only depends on \mathcal{X} and Δ .

Definition 1.5.8. An *admissible* combinatorial type of degree Δ curves in \mathcal{X} is a combinatorial type α such that for all vertices v of α we have $\text{rdim}(v) \geq 0$. These are exactly the combinatorial types which we would expect to be "locally realisable", cf. Section 2.3.

We denote by $\mathcal{M}_{\Delta, \mathcal{X}}^{\text{ad}}$ the polyhedral complex consisting of those cones $\overline{\mathcal{M}(\alpha)}$ such that α is admissible, and all faces $\overline{\mathcal{M}(\beta)} \subset \overline{\mathcal{M}(\alpha)}$ also belong to admissible combinatorial types β .

For the rest of this section we will *only* consider admissible combinatorial types of curves in \mathcal{X} , except for Lemma 1.5.16. Furthermore let Δ be a fixed degree of tropical curves in \mathcal{X} . In order to define our moduli space $\mathcal{M}_0(\mathcal{X}, \Delta)$ as a tropical cycle we will need to specify some additional data as in the following definition. Also we will need to require some kind of compatibility condition for this data, as we will do in Definition 1.5.12. Then we will be able to "glue" $\mathcal{M}_0(\mathcal{X}, \Delta)$ from this information in Construction 1.5.13.

Definition 1.5.9. *Moduli data* for curves (respectively hypersurfaces) are a collection of weights $(\omega_{[(\mathcal{X}', \Delta')]}_{[(\mathcal{X}', \Delta')]})$ from \mathbb{Q} for every vertex type $[(\mathcal{X}', \Delta')]$ with $\text{rdim}(\mathcal{X}', \Delta') = 0$. Here \mathcal{X}' is a smooth tropical fan which is a curve (respectively hypersurface) in some ambient vector space. Furthermore, in the hypersurface case we want to require that for the projection $\text{pr} : L_r^q \times \mathbb{R}^m \rightarrow L_r^q$ we have $\omega_{[(L_r^q \times \mathbb{R}^m, \Delta')]} = \omega_{[(L_r^q, \text{pr}(\Delta'))]}$. A promising choice of moduli data for the hypersurface case seem to be the numbers from Conjecture 3.1.7. The correct choice for the curve case is Definition 3.2.8.

Definition 1.5.10 (The moduli space $\mathcal{M}_0(\mathcal{X}, \Delta)$). We want to define $\mathcal{M}_0(\mathcal{X}, \Delta)$ as the polyhedral complex consisting of all cells $\overline{\mathcal{M}(\alpha)}$ of $\mathcal{M}_{\Delta, \mathcal{X}}^{\text{ad}}$ such that

$$\dim \mathcal{M}(\alpha) = \dim \mathcal{X} + |\Delta| - 3 - K_{\mathcal{X}} \cdot \Delta$$

together with all of their faces. So $\mathcal{M}_0(\mathcal{X}, \Delta)$ is pure by definition. The dimension of $\mathcal{M}_0(\mathcal{X}, \Delta)$ is exactly the expected dimension of the corresponding algebraic moduli space. Furthermore, if (\mathcal{X}, Δ) is a vertex type, then $\dim \mathcal{M}_0(\mathcal{X}, \Delta) = \text{vdim}(\mathcal{X}, \Delta)$.

For a cell $\overline{\mathcal{M}(\alpha)} \in \mathcal{M}_0(\mathcal{X}, \Delta)$ define $\mathcal{N}(\alpha) := \mathcal{M}_0(\mathcal{X}, \Delta)(\overline{\mathcal{M}(\alpha)})$ and $\mathcal{N}'(\alpha) := q_{[N]}^{-1}(\mathcal{N}(\alpha))$ for the quotient morphism $q_{[N]} : \mathcal{M}'_0(\mathbb{R}^m, \Delta) \rightarrow \mathcal{M}_0(\mathbb{R}^m, \Delta)$. If $\overline{\mathcal{M}(\alpha)} \notin \mathcal{M}_0(\mathcal{X}, \Delta)$, we set $\mathcal{N}(\alpha) := \mathcal{N}'(\alpha) := \emptyset$.

We postpone the definition of weights on $\mathcal{M}_0(\mathcal{X}, \Delta)$ to Definition 1.5.20 as this involves results from later in this chapter, except for the special case of the next construction.

Note that in general there are also admissible combinatorial types of too high dimension, cf. Example 1.6.4. It is not known to the author if there are cases where all admissible combinatorial types are of too small dimension. Furthermore, the weights on $\mathcal{M}_0(\mathcal{X}, \Delta)$ will in general not be integral and $\mathcal{M}_0(\mathcal{X}, \Delta)$ does not have to be irreducible, cf. the examples in the next section 1.6.

Note that *all* following constructions and definitions in this section will depend on the choice of moduli data.

Construction 1.5.11. Let (\mathcal{X}', Δ') be a vertex type with $\text{rdim}(\mathcal{X}', \Delta') = 0$, where \mathcal{X}' is a closed smooth affine tropical fan which is either a hypersurface or a curve. Then by Definition 1.5.10 $\mathcal{M}_0(\mathcal{X}', \Delta')$ consists of exactly one cell, the cell $\mathcal{M}(\tau)$ belonging to the trivial combinatorial type τ . We want to equip the cell $\mathcal{M}_0(\mathcal{X}', \Delta')$ with the weight $\omega_{[(\mathcal{X}', \Delta')]}$ from the moduli data, turning $\mathcal{M}_0(\mathcal{X}', \Delta')$ into a tropical variety.

Unfortunately, the following definition recursively uses Construction 1.5.13 and Definition 1.5.20 from later in this chapter. However, this is possible by induction on the classification number.

Definition 1.5.12 (Good vertices). Let α be a combinatorial type of degree Δ curves in \mathcal{X} . We want to define when a vertex v of α is *good*. For this we assume that the notion of a good vertex is already defined for all vertices with classification number strictly smaller than N_v . We will now state the definition and afterwards explain why the occurring objects are well-defined. The vertex v is called *good* if the following holds:

- (1) if γ is a non-trivial resolution of v with $\dim \mathcal{M}(\gamma) \leq \text{vdim}(v)$, all vertices of γ are good vertices
- (2) the space $\mathcal{M}_0(\mathcal{X}_v, \Delta_v)$ from Definition 1.5.10 is a tropical variety, with weights from Construction 1.5.11 if $\text{rdim}(v) = 0$ and weights from Definition 1.5.20 if $\text{rdim}(v) > 0$
- (3) $\mathcal{M}_0(\mathcal{X}_v, \Delta_v) \cap \mathcal{N}(\gamma) = \mathcal{Z}(\gamma)$ for every non-trivial resolution γ of v such that $\dim \mathcal{M}(\gamma) \leq \text{vdim}(v)$, where $\mathcal{Z}(\gamma)$ is the cycle defined in Construction 1.5.13.

Let us see why this is well-defined. If w is a vertex of a non-trivial resolution of v , then $N_w < N_v$ by Lemma 1.5.7. Hence it is by assumption already defined what it means that w is a good vertex, so condition (1) makes sense. In condition (2) we only have to take care what happens if $\text{rdim}(v) > 0$. If this is the case, we can apply Definition 1.5.20 because condition (1) is satisfied. Also in condition (3) the cycle $\mathcal{Z}(\gamma)$ is well-defined as by (1) the vertices of γ are good. Therefore we can also say what it means for v to be good.

The definition of a good vertex seems to be quite messed up because of the recursion and because it involves the gluing construction, which also relies on good vertices. After Construction 1.5.13 we will explain in Example 1.5.14, why this is necessary.

We will see in Lemma 1.5.15 that the property of being a good vertex actually only depends on the vertex type of the vertex.

Note that if $\text{rdim}(v) = 0$ then v is always good, as conditions (1) and (3) are trivially satisfied and condition (2) is satisfied by Construction 1.5.11.

Now we can describe how we want to glue moduli spaces from these building blocks.

Construction 1.5.13 (Gluing). Fix a combinatorial type $\alpha = (G, (\Delta_v, \sigma_v)_{v \in V_G})$ of degree Δ curves in \mathcal{X} and assume all its vertices are good. We now want to cut α along all its edges as in Construction 1.5.5 and obtain pieces α_v for all vertices v of α . In the following let F^v denote the flags of α which are incident to v , i.e. the leaves of α_v . Furthermore, the graphs

of a combinatorial type need to be labelled graphs, and we want to label the graphs in α_v by F^v in the obvious way.

We want to associate a *local moduli space* \mathcal{M}_v to each vertex v as follows. For a vertex v we have an affine tropical fan \mathcal{X}_v with $\mathcal{X}_v \cap \mathcal{X}(\sigma_v) = \mathcal{X} \cap \mathcal{X}(\sigma_v)$ as in (16). Now the space $\mathcal{M}_0(\mathcal{X}_v, \Delta_v)$ is a tropical variety as the vertex is good. We can now make all leaves bounded by taking the preimage variety (cf. Construction 1.1.13) under q_{F^v} (cf. Definition 1.2.18), and we obtain $\mathcal{M}'_0(\mathcal{X}_v, \Delta_v)$ with the polyhedral structure induced by $\mathcal{M}_0(\mathcal{X}_v, \Delta_v)$.

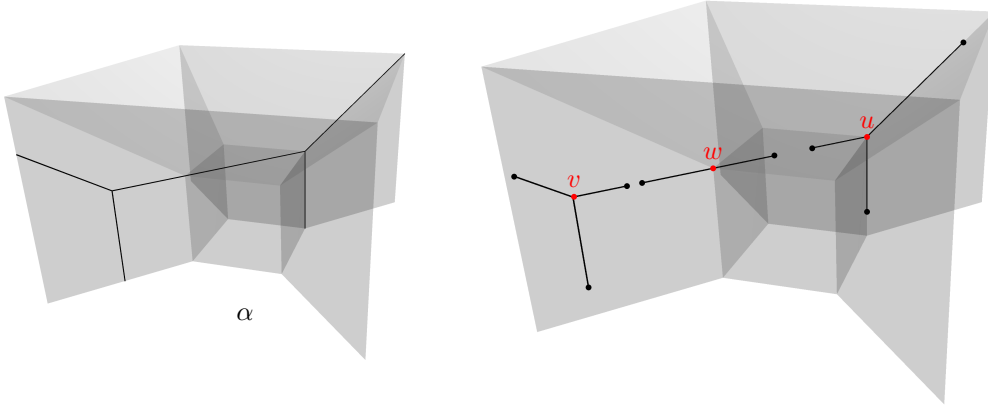

Let $U \subset |\mathcal{M}'_0(\mathcal{X}_v, \Delta_v)|$ be the subset of all curves $(\Gamma, (x_{f'})_{f' \in F^v}, h)$ such that $h(|\Gamma|^\circ) \subset \mathcal{X}(\sigma_v)$. This is an open polyhedral subset of $|\mathcal{M}'_0(\mathcal{X}_v, \Delta_v)|$ which intersects every cell of $\mathcal{M}'_0(\mathcal{X}_v, \Delta_v)$. The reason is that on each cell of $\mathcal{M}'_0(\mathcal{X}_v, \Delta_v)$ the position of the image of a vertex is linear. Hence we can require that all vertices are mapped into $\mathcal{X}(\sigma_v)$, which is open in $|\mathcal{X}_v|$. The edges are then also mapped into $\mathcal{X}(\sigma_v)$ as the cells of \mathcal{X} are convex. We define the *local moduli space of v* as the restriction

$$(17) \quad \mathcal{M}_v := \mathcal{M}'_0(\mathcal{X}_v, \Delta_v) \cap U$$

which is a partially open affine tropical fan.

Now we want to glue the pieces \mathcal{M}_v back together. Consider an edge $e = \{f_1, f_2\} = \{v_1, v_2\}$ of α which is mapped into the relative interior of σ_e . We denote $\mathcal{X}_e := \mathcal{X} \cap \mathcal{X}(\sigma_e)$ and we evaluate

$$\text{ev}_e := (\text{ev}_{f_1} \times \text{ev}_{f_2}) \circ \text{pr} : \prod_{v \in V_\alpha} \mathcal{M}_v \longrightarrow \mathcal{X}_e^2$$

where pr denotes the projection onto $\mathcal{M}_{v_1} \times \mathcal{M}_{v_2}$. Then we want to impose the condition that the leaves fit together to the edge e by pulling back the diagonal $\Delta_{\mathcal{X}_e}$ via ev_e with Construction 1.4.2. This pull back is contained in the set $\text{ev}_e^{-1} |\Delta_{\mathcal{X}_e}|$. We abbreviate

$$\left(\prod_{e \in E_\alpha} \text{ev}_e^* \Delta_{\mathcal{X}_e} \right) \cdot \prod_{v \in V_\alpha} \mathcal{M}_v =: \text{ev}^* \Delta_{\mathcal{X}} \cdot \prod_{v \in V_\alpha} \mathcal{M}_v.$$

By Lemma 1.4.6 this does not depend on the order of the edges.

We define $\text{ev}^{-1} \Delta_{\mathcal{X}} := \bigcap_{e \in E_\alpha} \text{ev}_e^{-1} |\Delta_{\mathcal{X}_e}|$. So $\text{ev}^{-1} \Delta_{\mathcal{X}} \subset \prod_{v \in V_\alpha} |\mathcal{M}_v|$ consists of all curve pieces that fit together to a curve of degree Δ , but it also carries the superfluous information about the position of the gluing points which we want to get rid of by taking a quotient. Furthermore we have

$$\left| \text{ev}^* \Delta_{\mathcal{X}} \cdot \prod_{v \in V_\alpha} \mathcal{M}_v \right| \subset \text{ev}^{-1} \Delta_{\mathcal{X}},$$

as this is the case for each intersection of a diagonal pull back by Construction 1.4.2.

Now we want to describe the lineality space that we have to mod out in order to forget the gluing points. Each cycle \mathcal{M}_v lies in a vector space $U_v := Q'_{F^v} \times \mathbb{R}^m$, cf. Constructions 1.2.9

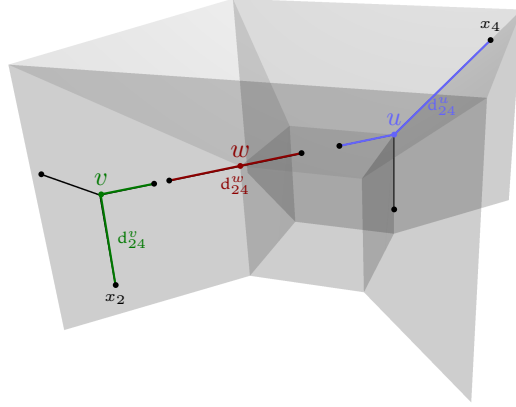

FIGURE 2. Here we see an example for the map D_{24} which measures the distance between the leaves x_2 and x_4 . It is the sum of the maps d_{24}^v , d_{24}^w and d_{24}^u which measure the length of the coloured path in the graph.

and 1.2.20. If v is at least trivalent and $f' \in F^v$, we have a vector $u_{f'} \in U_v$ whose coefficient records the length of the bounded leaf f' , cf. Construction 1.2.9. If v is two-valent, incident to f_1 and f_2 , then the coefficient of $u_{f_1} = u_{f_2} \in U_v$ records the distance between these two leaves. We define

$$(18) \quad L_\alpha := \langle u_{f_1} - u_{f_2} \mid \{f_1, f_2\} \in E_\alpha \rangle_{\mathbb{R}} \subset \prod_{v \in V_\alpha} U_v.$$

For each edge e of α the evaluation ev_e maps L_α into Δ_{σ_e} , a central cell of $\Delta_{\mathcal{X}_e}$. Therefore L_α is a lineality space of the pull back by Lemma 1.4.4. Hence L_α is a lineality space of $\text{ev}^* \Delta_{\mathcal{X}} \cdot \prod_{v \in V_\alpha} \mathcal{M}_v$. So as in Construction 1.1.11 we can mod out L_α and we denote the quotient map $q : \prod_{v \in V_\alpha} U_v \rightarrow (\prod_{v \in V_\alpha} U_v) / L_\alpha$. The quotient does no longer carry the information about the position of the gluing points.

Now we want to obtain elements in $\mathcal{M}'_0(\mathbb{R}^m, \Delta) \cong \mathcal{M}'_{0,N} \times \mathbb{R}^m$ in barycentric coordinates, via a morphism f which we want to describe in the following. In order to do this, we identify $Q'_N \cong \mathbb{R}^{\binom{N}{2}}$. Let x_i and x_j be two leaves of α and denote by $d_{ij}^v : \mathcal{M}_v \rightarrow \mathbb{R}$ the morphism that measures the distance between the two unique leaves in \mathcal{M}_v which lie on the path from x_i to x_j in α . If v does not lie on the path from x_i to x_j , we set $d_{ij}^v = 0$. Furthermore denote the composition of d_{ij}^v with the projection $\text{pr}_v : \prod_{w \in V_\alpha} \mathcal{M}_w \rightarrow \mathcal{M}_v$ by \tilde{d}_{ij}^v . We can define the total distance between x_i and x_j as $D_{ij} := \sum_{v \in V_\alpha} \tilde{d}_{ij}^v$, cf. Figure 2. It can be checked that this factors uniquely through the quotient by L_α as $D_{ij} = D'_{ij} \circ q$. For all vertices v of α let $\text{bc}^v : \mathcal{M}_v \rightarrow \mathbb{R}^m$ be the barycentre morphism and let $\tilde{\text{bc}}^v := \text{bc}^v \circ \text{pr}_v$. We can define a morphism $B := \sum_{v \in V_\alpha} \tilde{\text{bc}}^v + \sum_{\{f_1, f_2\} \in E_\alpha} (\text{ev}_{f_1} + \text{ev}_{f_2})$. The second sum deletes the contribution of the gluing points to the barycentre. Hence also B factors uniquely as $B = B' \circ q$. As the total mass of the glued curve is -2 we want to define f as

$$(19) \quad f := \prod_{i < j} D'_{ij} \times \left(-\frac{1}{2} B' \right) : q[\text{ev}^{-1} \Delta_{\mathcal{X}}] \rightarrow \mathcal{M}'_{0,n}(\mathbb{R}^m, \Delta).$$

It is not difficult to see that the factor $-\frac{1}{2}$ is compatible with the lattices and hence f is a morphism. This morphism maps a tuple of curve pieces to the unique curve in $\mathcal{M}'_0(\mathbb{R}^m, \Delta)$ which is glued from these pieces. Hence f is injective on this set and we can now define

the push forward

$$(20) \quad f_*q \left[\text{ev}^* \Delta_{\mathcal{X}} \cdot \prod_{v \in V_{\alpha}} \mathcal{M}_v \right] =: \mathcal{Z}'(\alpha) \subset |\mathcal{M}'_{0,n}(\mathbb{R}^m, \Delta)|.$$

Note that $|\mathcal{Z}'(\alpha)| \subset (f \circ q)(\text{ev}^{-1} \Delta_{\mathcal{X}})$, so the cycle $\mathcal{Z}'(\alpha)$ consists of degree Δ curves in \mathcal{X} with bounded leaves. It is very easy to obtain a cycle $\mathcal{Z}(\alpha)$ in $\mathcal{M}_0(\mathbb{R}^m, \Delta)$, by just dividing $\mathcal{Z}'(\alpha)$ by the lineality space $U_{[N]}$ via the quotient map $q_{[N]}$. Then by construction $|\mathcal{Z}(\alpha)| \subset |\mathcal{M}'_{\mathcal{X}, \Delta}|_{\text{poly}}$. The cells of maximal dimension come with a natural weight in this construction, which we will call *gluing weight*. It is not clear a priori that this weight is independent of the choice of α , but it will turn out to be so in Theorem 1.5.21.

Example 1.5.14. Consider the tropical degree $\Delta = (3e_1, 2e_0 + e_3, 2e_2 + e_3, e_0 + e_3, e_2)$ of curves in L_2^3 . In the picture below the leaf x_1 is black while x_2 and x_3 are red and x_4 and x_5 are green. We have $\text{rdim}(L_2^3, \Delta) = 1$, and one possible combinatorial type α of degree Δ curves in L_2^3 of geometric dimension one is depicted below. The vertices v and u are of resolution dimension zero, but we have $\text{rdim}(w) = \text{vdim}(w) = 1$. In order to define $\mathcal{Z}(\alpha)$, we need local moduli spaces $\mathcal{M}_u, \mathcal{M}_v$ and \mathcal{M}_w as in (17). While \mathcal{M}_u and \mathcal{M}_v are already defined in Construction 1.5.11, \mathcal{M}_w is a one-dimensional affine tropical fan by Definition 1.5.10, whose weights are defined by gluing resolutions of w (also cf. Example 1.6.3). Therefore we need to construct $\mathcal{M}_0(L_2^3, \Delta)$ inductively from vertices with smaller classification number. In particular this example also shows that the resolution dimension does not strictly decrease in resolutions.

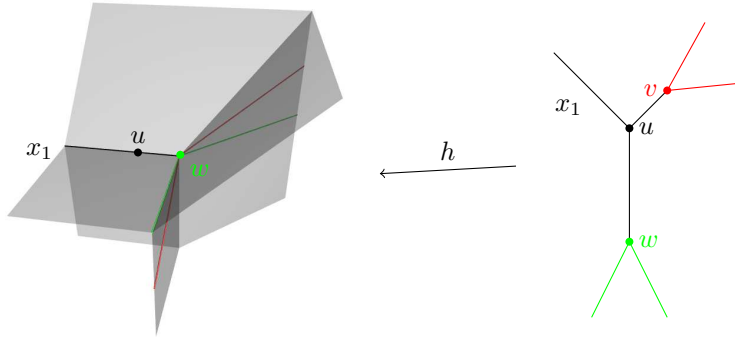

Let $\Delta = (\delta_1, \dots, \delta_N)$. Then every automorphism $\varphi : \mathbb{R}^m \rightarrow \mathbb{R}^m$ induces an isomorphism between moduli spaces $\phi : \mathcal{M}_0(\mathbb{R}^m, \Delta) \rightarrow \mathcal{M}_0(\mathbb{R}^m, \varphi\Delta)$ via $\phi(\Gamma, x_1, \dots, x_N, h) := (\Gamma, x_1, \dots, x_N, \varphi \circ h)$, where $\varphi\Delta := (\varphi_{\text{lin}}(\delta_1), \dots, \varphi_{\text{lin}}(\delta_N))$ is the image of Δ under the linear part of φ . We now want to see that Construction 1.5.13 behaves well under automorphisms of \mathbb{R}^m .

Lemma 1.5.15. *Assume that all vertices of a combinatorial type α of degree Δ curves in \mathcal{X} are good. For an automorphism $\varphi : \mathbb{R}^m \rightarrow \mathbb{R}^m$ the induced isomorphism between the moduli spaces $\phi : \mathcal{M}_0(\mathbb{R}^m, \Delta) \rightarrow \mathcal{M}_0(\mathbb{R}^m, \varphi\Delta)$ satisfies*

$$\phi_* \mathcal{Z}(\alpha) = \mathcal{Z}(\varphi(\alpha)).$$

Here for a combinatorial type $\alpha = (G, (\sigma_v, \Delta_v)_{v \in V_G})$ the combinatorial type $\varphi(\alpha)$ is given by $(G, (\varphi(\sigma_v), \varphi\Delta_v)_{v \in V_G})$. In particular the property that a vertex is good only depends on its vertex type.

PROOF. The automorphism φ also induces isomorphisms

$$\phi^v : \mathcal{M}_0(\mathbb{R}^m, \Delta_v) \xrightarrow{\sim} \mathcal{M}'_0(\mathbb{R}^m, \varphi\Delta_v).$$

We want to denote the local moduli space (as in (17)) of v in α by \mathcal{M}_v and the one of v in $\varphi(\alpha)$ by $\mathcal{M}_{\varphi(v)}$. Strictly speaking, the existence of a moduli space $\mathcal{M}_{\varphi(v)}$ is not clear yet

as we do not know that the vertex v is also a good vertex in $\varphi(\alpha)$, but this will be proven below. We want to denote the quotient maps by

$$q : \prod_v \mathcal{M}_v \longrightarrow \left(\prod_v \mathcal{M}_v \right) / L_\alpha \quad \text{and} \quad \tilde{q} : \prod_v \mathcal{M}_{\varphi(v)} \longrightarrow \left(\prod_v \mathcal{M}_{\varphi(v)} \right) / L_{\varphi(\alpha)}.$$

As we clearly have $(\prod_v \phi^v)(L_\alpha) = L_{\varphi(\alpha)}$ there is an isomorphism $\tilde{\phi}$ with $\tilde{\phi} \circ q = \tilde{q} \circ (\prod_v \phi^v)$. For each edge e of α (and hence also $\varphi(\alpha)$), we obtain an evaluation morphism $\text{ev}_e : \prod_v \mathcal{M}_v \longrightarrow \mathcal{X}_e^2$ as in Construction 1.5.13. The same way we obtain an evaluation $\tilde{\text{ev}}_e : \prod_v \mathcal{M}_{\varphi(v)} \longrightarrow (\varphi_* \mathcal{X}_e)^2$, satisfying $\text{ev}_e = \tilde{\text{ev}}_e \circ (\prod_v \phi^v)$. We want to denote the embeddings as in (19) into $\mathcal{M}'_0(\mathbb{R}^m, \Delta)$ by f and the one into $\mathcal{M}'_0(\mathbb{R}^m, \varphi\Delta)$ by \tilde{f} .

First we assume that \mathcal{X} is an affine tropical fan and $\text{rdim}(\mathcal{X}, \Delta) > 0$. If $\text{rdim}(\mathcal{X}, \Delta) = 0$, the statement $\phi_* \mathcal{M}_0(\mathcal{X}, \Delta) = \mathcal{M}_0(\varphi_* \mathcal{X}, \varphi\Delta)$ is just Construction 1.5.11, by the definition of a vertex type.

So let w denote the unique vertex of the trivial combinatorial type τ of degree Δ curves in \mathcal{X} . Assume that α is a non-trivial combinatorial type of degree Δ curves in \mathcal{X} . Then we have $N_w > N_v$ for the classification numbers of the vertices v of α . If $\text{rdim}(v) = 0$ we have $\phi_*^v \mathcal{M}_v = \mathcal{M}_{\varphi(v)}$ as above, in particular v is also good in $\varphi(\alpha)$. The smallest possible classification number is 3, which is attained only for (\mathbb{R}^k, Δ') , where $|\Delta'| = 3$. In this case we have $\text{rdim}(\mathbb{R}^k, \Delta') = 0$. So by induction on the classification number we can assume that $\phi_* \mathcal{M}_v = \mathcal{M}_{\varphi(v)}$ and that v is also good in $\varphi(\alpha)$ for all vertices v of α . We obtain

$$\begin{aligned} \phi_* \mathcal{Z}'(\alpha) &= \phi_* f_* q \left[\text{ev}^* \Delta_{\mathcal{X}} \cdot \prod_v \mathcal{M}_v \right] \stackrel{(1)}{=} \tilde{f}_* \tilde{\phi}_* q \left[\text{ev}^* \Delta_{\mathcal{X}} \cdot \prod_v \mathcal{M}_v \right] \\ &\stackrel{(2)}{=} \tilde{f}_* \tilde{q} \left[\left(\prod_v \phi^v \right)_* \left[\left(\prod_e \text{ev}_e^* \Delta_{\mathcal{X}_e} \right) \cdot \prod_v \mathcal{M}_v \right] \right] \\ &\stackrel{(3)}{=} \tilde{f}_* \tilde{q} \left[\left(\prod_e \tilde{\text{ev}}_e^* \Delta_{\mathcal{X}_e} \right) \cdot \left(\prod_v \phi^v \right)_* \left[\prod_v \mathcal{M}_v \right] \right] \\ &= \tilde{f}_* \tilde{q} \left[\left(\prod_e \tilde{\text{ev}}_e^* \Delta_{\mathcal{X}_e} \right) \cdot \prod_v \mathcal{M}_{\varphi(v)} \right] \stackrel{\text{def.}}{=} \mathcal{Z}'(\varphi(\alpha)). \end{aligned}$$

Here equality (1) holds because $\phi \circ f = \tilde{f} \circ \tilde{\phi}$ and equality (2) holds by an application of Lemma 1.3.11 to $\tilde{\phi} \circ q = \tilde{q} \circ (\prod_v \phi^v) \circ \text{id} \circ \text{id}$. Equality (3) is then just the projection formula from Lemma 1.4.5 applied several times. Applying this to all combinatorial types α yields

$$\phi_* \mathcal{M}'_0(\mathcal{X}_w, \Delta_w) = \phi_* \mathcal{M}'_0(\mathcal{X}, \Delta) = \mathcal{M}'_0(\varphi_* \mathcal{X}, \varphi\Delta) = \mathcal{M}'_0(\varphi_* \mathcal{X}_w \varphi\Delta_w).$$

In particular the vertex w is also good in $\varphi(\tau)$.

If there is *only* the trivial combinatorial type τ , the same also holds for $\varphi_* \mathcal{X}$ and $\varphi\Delta$. Then $[\mathcal{Z}(\tau)] = [\mathcal{M}_0(\mathcal{X}, \Delta)] = [\emptyset]$ and also $[\emptyset] = [\mathcal{M}_0(\varphi_* \mathcal{X}, \varphi\Delta)] = [\mathcal{Z}(\varphi(\tau))] = \phi_* [\mathcal{Z}(\tau)]$ by Definition 1.5.10. In particular, also in this case w is a good vertex of $\varphi(\tau)$.

Therefore we can assume $\phi_*^v \mathcal{M}_v = \mathcal{M}_{\varphi(v)}$ holds for all vertices (vertex types) and we can use the above computation to obtain the claim for general smooth \mathcal{X} . \square

Now we will state a lemma which deals with arbitrary combinatorial types in an arbitrary tropical polyhedral complex, as we will need this to relate combinatorial types to boundary strata of an algebraic moduli space in Section 2.4.

Lemma 1.5.16. *Let \mathcal{X} be an arbitrary tropical polyhedral complex. Furthermore let α and β be arbitrary combinatorial types of degree Δ curves in \mathcal{X} . Suppose there is a choice E of edges in β such that the pieces obtained from cutting β along E are in bijection to the vertices of α and call these pieces $(\beta_v)_v$. If β_v is a resolution of v for every vertex v of α , then $\beta \geq \alpha$.*

PROOF. By assumption each β_v is a combinatorial type of degree Δ_v curves in \mathcal{X}_v , where \mathcal{X}_v is as in (16). This proof will be very similar to Construction 1.5.13, the only difference is that we do not have local moduli spaces as tropical varieties, so we will replace $\mathcal{M}_0(\mathcal{X}_v, \Delta_v)$ by the polyhedral complex $\mathcal{M}_{\mathcal{X}_v, \Delta_v}$. Given a cone $\overline{\mathcal{M}}(\gamma) \in \mathcal{M}_{\mathcal{X}_v, \Delta_v}$ let $\overline{\mathcal{M}}'(\gamma) := q_{[N]}^{-1}(\overline{\mathcal{M}}(\gamma))$, where $q_{[N]}$ is as in Definition 1.2.18. Let $\sigma_v(\gamma) \subset \overline{\mathcal{M}}'(\gamma)$ be the subset of all curves $(\Gamma, (x_{f'})_{f'}, h)$ with $h(|\Gamma|^\circ) \subset \mathcal{X}(\sigma_v)$. We define \mathcal{M}_v as the collection of cones $\sigma_v(\gamma)$ for all (not only admissible ones) combinatorial types γ of degree Δ_v curves in \mathcal{X}_v . This is an affine fan with central cell $\sigma_v(\tau_v)$, where τ_v denotes the trivial combinatorial type of degree Δ_v curves in \mathcal{X}_v .

For a polyhedral complex \mathcal{Z} we want to define the diagonal to be the polyhedral complex $\Delta_{\mathcal{Z}} = \{\iota(\sigma) \mid \sigma \in \mathcal{Z}\}$ where $\iota(x) = (x, x)$.

Each edge $e \in E$ is mapped into the relative interior of a cell $\sigma_e \in \mathcal{X}$. Define a polyhedral complex $\mathcal{X}_e := \{\sigma \cap \mathcal{X}(\sigma_e) \mid \sigma \in \mathcal{X}\}$ and a linear evaluation map

$$\text{ev}_e : \prod_{v \in V_\alpha} \mathcal{M}_v \longrightarrow |\mathcal{X}_e|_{\text{poly}}^2 \subset |\mathcal{X}|_{\text{poly}}^2,$$

for every $e \in E$ as in Construction 1.5.13. We now want to consider the set

$$G := \bigcap_{e \in E} \text{ev}_e^{-1} |\Delta_{\mathcal{X}_e}|_{\text{poly}}$$

The set G consists of curve pieces that glue to curves of degree Δ . Let L_α , q and the embedding $f : q(G) \longrightarrow \mathcal{M}'_0(\mathbb{R}^m, \Delta)$ be as in Construction 1.5.13. Obviously $M_\alpha := (f \circ q)^{-1} \mathcal{M}'(\alpha)$ is a polyhedron with $M_\alpha \subset \prod_v \sigma_v(\tau_v)$. Now we want to find a polyhedral complex \mathcal{G} with $|\mathcal{G}|_{\text{poly}} = G$. We start with $\mathcal{G}_0^0 := \prod_v \mathcal{M}_v$. By replacing $l = c$ with $l \geq c$ and $-l \geq -c$ we can assume that all defining relations of a polyhedron are inequalities. Let $E = \{e_1, \dots, e_s\}$ and let $l_i^j \geq c_i^j$ for $i = 1, \dots, r_j$ be all those defining inequalities of all cells of $\Delta_{\mathcal{X}_{e_j}}$, which are *not strict*. We then define

$$\mathcal{G}_i^j := \{\sigma \cap \{l_i^j \circ \text{ev}_{e_j} \geq c_i^j\}, \sigma \cap \{l_i^j \circ \text{ev}_{e_j} = c_i^j\}, \sigma \cap \{l_i^j \circ \text{ev}_{e_j} \leq c_i^j\} \mid \sigma \in \mathcal{G}_{i-1}^j\}$$

and

$$\mathcal{G}_1^j := \{\sigma \cap \{l_i^j \circ \text{ev}_{e_j} \geq c_i^j\}, \sigma \cap \{l_i^j \circ \text{ev}_{e_j} = c_i^j\}, \sigma \cap \{l_i^j \circ \text{ev}_{e_j} \leq c_i^j\} \mid \sigma \in \mathcal{G}_{r_j-1}^{j-1}\}.$$

It is clear from the construction, that G is a union of cones in $\mathcal{G}_{r_s}^s$. Let \mathcal{G} be the set of these cones.

Now we want to show that each \mathcal{G}_i^j is an affine fan which contains M_α in its central cell. This can be seen by induction. The claim is clearly true for \mathcal{G}_0^0 . Assume that the partially open polyhedron M_α is a subset of every $\sigma \in \mathcal{G}_i^j$. By definition we have $\text{ev}_{e_j}(M_\alpha) \subset \Delta_{\sigma_{e_j}^\circ}$. But as $\sigma_{e_j}^\circ$ is the central cell of \mathcal{X}_{e_j} , we have that $(l_i^j \circ \text{ev}_{e_j})(M_\alpha) = \{c_i^j\}$. So if M_α is contained in every cell of \mathcal{G}_i^j , it is also contained in every cell of \mathcal{G}_{i+1}^j , respectively \mathcal{G}_1^{j+1} if $i = r_j$. This means that also \mathcal{G}_{i+1}^j (respectively \mathcal{G}_1^{j+1} if $i = r_j$) is an affine fan such that each of its cells contains M_α . Hence this also holds for \mathcal{G} . By definition of M_α we have $\langle x - y \mid x, y \in M_\alpha \rangle_{\mathbb{R}} \supset L_\alpha$. So the affine fan \mathcal{G} has lineality space L_α and hence also $q(\mathcal{G})$ is an affine fan. As f is injective, we conclude that $(f \circ q)(\mathcal{G})$ is an affine fan, such that each of its cells contains $\mathcal{M}'(\alpha)$.

As β is a combinatorial type of degree Δ curves in \mathcal{X} , we must have a cell $\sigma \in \mathcal{G}$ such that $\sigma \subset \prod_v \sigma_v(\beta_v)$. Then $(f \circ q)(\sigma) \subset \overline{\mathcal{M}}'(\beta)$ and as $\mathcal{M}'(\alpha) \subset (f \circ q)(\sigma)$, we conclude $\beta \geq \alpha$.

In particular the preceding arguments also show that $(f \circ q)(G) \subset \mathcal{N}'_{\Delta, \mathcal{X}}(\alpha)$. Given a cell $\sigma \in \mathcal{G}$ there must be a combinatorial type γ of degree Δ curves in \mathcal{X} such that $(f \circ q)(\sigma) \subset \overline{\mathcal{M}}'(\gamma)$. As before, we conclude $\gamma \geq \alpha$, hence $(f \circ q)(\sigma) \subset \mathcal{N}'_{\Delta, \mathcal{X}}(\alpha)$. \square

Lemma 1.5.17. *Assume that all vertices of a combinatorial type α of degree Δ curves in \mathcal{X} are good. Then the gluing cycle $\mathcal{Z}(\alpha)$ is an affine tropical fan containing $\mathcal{M}(\alpha)$ in a central cell, furthermore $|\mathcal{Z}(\alpha)| \subset \mathcal{N}_{\Delta, \mathcal{X}}(\alpha)$.*

PROOF. Let the notation be as in Construction 1.5.13. Consider the set of all curve pieces that glue to combinatorial type α , i.e. $M_\alpha := q^{-1}f^{-1}(\mathcal{M}'(\alpha)) \subset \text{ev}^{-1}\Delta_{\mathcal{X}}$. Then $\text{ev}_e(M_\alpha) \subset \Delta_{\sigma_e^\circ} \subset \sigma_e^\circ \times \sigma_e^\circ$, for every edge e of α .

Let \mathcal{Z} be an affine tropical fan that is a subvariety of $\prod_{v \in V_\alpha} \mathcal{M}_v$ and contains M_α in a central cell. As in Construction 1.4.2, let $f_1^e \times f_2^e : \mathcal{Z} \times \mathbb{R}^2 \rightarrow \mathbb{B}(Q)^2 \times (\mathbb{R}^m)^2$ be the morphisms induced by $\text{ev}_e \times \text{id} : \mathcal{Z} \times \mathbb{R}^2 \rightarrow \mathcal{X}_e^2 \times \mathbb{R}^2$ and an embedding $\theta : \mathcal{X}_e \times \mathbb{R} \hookrightarrow \mathbb{B}(Q) \times \mathbb{R}^m$, where Q is some uniform matroid. As in Construction 1.4.2 we also call the projections to the factors $\pi_1 : \mathbb{B}(Q)^2 \times (\mathbb{R}^m)^2 \rightarrow \mathbb{B}(Q)^2$ and $\pi_2 : \mathbb{B}(Q)^2 \times (\mathbb{R}^m)^2 \rightarrow (\mathbb{R}^m)^2$.

The functions φ_i and ψ_j used for cutting out the diagonal in Construction 1.4.2 are all fan functions. If L_Q is the maximal lineality space of $\mathbb{B}(Q)$, the fan consisting of the domains of affine linearity of φ_i contains Δ_{L_Q} in its central cell. Similarly, the fan consisting of the domains of affine linearity of ψ_j contains $\Delta_{\mathbb{R}^m}$ in its central cell. As

$$\theta \times \theta : \Delta_{\sigma_e^\circ} \times \Delta_{\mathbb{R}} \hookrightarrow \Delta_{L_Q} \times \Delta_{\mathbb{R}^m},$$

we conclude that $(f_1^e)^* \pi_1^* \varphi_i$ is a fan function, such that $M_\alpha \times \Delta_{\mathbb{R}}$ is contained in the central cell of the fan of domains of affine linearity. Similarly, also $(f_2^e)^* \pi_2^* \psi_j$ is a fan function, such that $M_\alpha \times \Delta_{\mathbb{R}}$ is contained in the central cell of the fan of domains of affine linearity. Hence, by construction also $\text{ev}_e^* \Delta_{\mathcal{X}_e} \cdot \mathcal{Z}$ is an affine tropical fan with M_α contained in a central cell. Inductively, we obtain the same for $\text{ev}^* \Delta_{\mathcal{X}} \cdot \prod_v \mathcal{M}_v$. All these properties are preserved under taking quotient by L_α and push forward with the injective map f , hence $\mathcal{M}'(\alpha)$ is contained in a central cell of the affine tropical fan $\mathcal{Z}'(\alpha)$.

The set G from the previous lemma consists of all curve pieces that glue to degree Δ pieces in \mathcal{X} , therefore $\text{ev}^{-1}\Delta_{\mathcal{X}}$ from Construction 1.5.13 is contained in G . Hence this set satisfies $(f \circ q)(\text{ev}^{-1}\Delta_{\mathcal{X}}) \subset \mathcal{N}'_{\Delta, \mathcal{X}}(\alpha)$, by the last paragraph of the proof of the previous lemma. This implies $|\mathcal{Z}(\alpha)| \subset \mathcal{N}_{\Delta, \mathcal{X}}(\alpha)$. \square

Lemma 1.5.18. *Assume that all vertices of a combinatorial type α of degree Δ curves in \mathcal{X} are good, then*

$$\dim \mathcal{Z}(\alpha) = \dim \mathcal{X} + |\Delta| - 3 - K_{\mathcal{X}} \cdot \Delta.$$

PROOF. Let the notation be as in Construction 1.5.13. By definition we have

$$\mathcal{Z}'(\alpha) = f_* q \left[\text{ev}^* \Delta_{\mathcal{X}} \cdot \prod_v \mathcal{M}_v \right].$$

If s denotes the number of vertices v of α , then $s - 1$ is obviously the number of edges of α . As the push forward preserves dimensions, we only have to compute the dimension of $q(\text{ev}^* \Delta_{\mathcal{X}} \cdot \prod_v \mathcal{M}_v)$. We have that

$$\begin{aligned} \dim \prod_v \mathcal{M}_v &= \sum_v (\text{vdim}(v) + \text{val}(v)) \\ &= \sum_v (2 \text{val}(v) - (K_{\mathcal{X}} \cdot \Delta)_v + \dim \mathcal{X} - 3) \\ &= s \dim \mathcal{X} - K_{\mathcal{X}} \cdot \Delta + \sum_v (\text{val}(v) - 3) + \sum_v \text{val}(v) \\ &= s \dim \mathcal{X} - K_{\mathcal{X}} \cdot \Delta + 2|\Delta| - 4 + s, \end{aligned}$$

where we take into account that for a tree the number of vertices satisfies $s = |\Delta| - 2 - \sum_v (\text{val}(v) - 3)$ and $\sum_v \text{val}(v) = |\Delta| + 2(s - 1)$. The cycle $\text{ev}^* \Delta_{\mathcal{X}} \cdot \prod_v \mathcal{M}_v$ has codimension $(s - 1) \dim \mathcal{X}$ and taking the quotient via q eliminates another $s - 1$ dimensions. Passing

from $\mathcal{M}'_0(\mathbb{R}^m, \Delta)$ to $\mathcal{M}_0(\mathbb{R}^m, \Delta)$ reduces the dimension by $|\Delta|$. From this the claim easily follows. \square

Corollary 1.5.19. *Assume that all vertices of a combinatorial type α of degree Δ curves in \mathcal{X} are good, then*

$$|\mathcal{Z}(\alpha)| \subset |\mathcal{M}_0(\mathcal{X}, \Delta)|_{\text{poly}},$$

In particular $|\mathcal{Z}(\alpha)| \subset \mathcal{N}(\alpha)$.

PROOF. If $\dim \mathcal{M}(\alpha) > \dim \mathcal{X} + |\Delta| - 3 - K_{\mathcal{X}} \cdot \Delta$ it follows from Lemmas 1.5.17 and 1.5.18 that $[\mathcal{Z}(\alpha)] = 0 \cdot [\mathcal{M}(\alpha)]$. The second part of the statement follows from $\mathcal{N}(\alpha) = \mathcal{N}_{\Delta, \mathcal{X}}(\alpha) \cap |\mathcal{M}_0(\mathcal{X}, \Delta)|_{\text{poly}}$. \square

Definition 1.5.20 (Weights on $\mathcal{M}_0(\mathcal{X}, \Delta)$). Assume that all vertices of *all* combinatorial types of degree Δ curves in \mathcal{X} are good. Then we can equip the maximal cells of $\mathcal{M}_0(\mathcal{X}, \Delta)$ with weights as follows. Let $\overline{\mathcal{M}(\alpha)}$ be a maximal cell. Then the gluing cycle $\mathcal{Z}(\alpha)$ defined in Construction 1.5.13 equals the cell $\mathcal{M}(\alpha)$ with some weight ω_α by Lemma 1.5.17 and Corollary 1.5.19. We define ω_α as the weight of $\overline{\mathcal{M}(\alpha)}$ in $\mathcal{M}_0(\mathcal{X}, \Delta)$. We will see in Theorem 1.5.21 that $\mathcal{M}_0(\mathcal{X}, \Delta)$ is balanced with these weights.

What is left to show is that $\mathcal{M}_0(\mathcal{X}, \Delta)$ becomes a tropical variety if we equip it with weights from the previous definition. The idea of the proof is that $\mathcal{M}_0(\mathcal{X}, \Delta)$ is locally given by gluing cycles $\mathcal{Z}(\alpha)$ for non-maximal combinatorial types, which are balanced by construction. We then have to show that the weights of two gluing cycles $\mathcal{Z}(\alpha)$ and $\mathcal{Z}(\beta)$ coincide where they are both defined, i.e. the gluing weights are well-defined.

Theorem 1.5.21. *Assume that all vertices that can possibly occur in combinatorial types of degree Δ curves in \mathcal{X} are good vertices and let β be a resolution of α . If $|\mathcal{Z}(\beta)| = \emptyset$ we have $|\mathcal{Z}(\alpha)| \cap \mathcal{M}(\beta) = \emptyset$. If $|\mathcal{Z}(\beta)| \neq \emptyset$, there is an open polyhedral subset $U \subset |\mathcal{Z}(\beta)|$ which is also an open subset of $|\mathcal{Z}(\alpha)|$ such that $\mathcal{M}(\beta) \subset U$ and*

$$\mathcal{Z}(\alpha) \cap U = \mathcal{Z}(\beta) \cap U.$$

In particular $\mathcal{M}_0(\mathcal{X}, \Delta)$ is a tropical variety and $\mathcal{Z}(\alpha) = \mathcal{M}_0(\mathcal{X}, \Delta) \cap \mathcal{N}(\alpha)$.

PROOF. For each vertex v in α there is a unique resolution β_v of v which is the piece of β obtained by cutting β along all edges inherited from α , cf. Construction 1.5.5. We now want to describe the gluing cycle for the combinatorial type β . For a vertex u of β we want to denote the local moduli space from (17) by \mathcal{N}_u in order to distinguish it from those belonging to vertices of α . Let

$$Q : \prod_{w \in V_\alpha} \prod_{u \in V_{\beta_w}} \mathcal{N}_u \longrightarrow \left(\prod_{w \in V_\alpha} \prod_{u \in V_{\beta_w}} \mathcal{N}_u \right) / L_\beta$$

denote the quotient map and let $\text{EV}^* \Delta_{\mathcal{X}}$ denote the product that glues all bounded edges in β as in Construction 1.5.13. We call the embedding into the moduli space

$$F : Q \left[\text{EV}^* \Delta_{\mathcal{X}} \cdot \prod_{w \in V_\alpha} \prod_{u \in V_{\beta_w}} \mathcal{N}_u \right] \longrightarrow \mathcal{M}'_0(\mathbb{R}^m, \Delta).$$

Let the gluing cycle of α be given by

$$\mathcal{Z}'(\alpha) = f_* q \left[\text{ev}^* \Delta_{\mathcal{X}} \cdot \prod_{v \in V_\alpha} \mathcal{M}_v \right]$$

with all the notation as in Construction 1.5.13.

Let $\sigma_{f'}$ be the cell of \mathcal{X} into whose relative interior the flag f' of α is mapped. Similarly, for an edge $e = \{f_1, f_2\}$ of α , σ_e denotes the cell into whose relative interior the edge

is mapped. Obviously, $\sigma_e = \sigma_{f_1} = \sigma_{f_2}$ in this case. In a resolution β of α , each flag will degenerate into the relative interior of a possibly bigger cell $\sigma_{f'}^\beta \geq \sigma_{f'}$. By Corollary 1.4.10 there exists a neighbourhood $\mathcal{F}_{f'}^\beta$ of $(\sigma_{f'}^\beta)^\circ$ in $\mathcal{X} \cap \mathcal{X}(\sigma_{f'}^\beta)$, such that pulling back the diagonal is compatible with restrictions, cf. Figure 3. We choose these neighbourhoods such that $\mathcal{F}_{f_1}^\beta = \mathcal{F}_{f_2}^\beta =: \mathcal{F}_e^\beta$ if $e = \{f_1, f_2\}$ is an edge of α , and such that the relative interior of $\sigma_e^\beta := \sigma_{f_1}^\beta = \sigma_{f_2}^\beta$ is a central cell of \mathcal{F}_e^β . For every vertex u of β we want to define

$$(21) \quad \mathcal{N}_u^\varepsilon := \mathcal{N}_u \cap \bigcap_{f'} \text{ev}_{f'}^{-1} | \mathcal{F}_{f'}^\beta |$$

where the intersection runs over all flags f' of α which are incident to u and element of an edge of α . For edges e of α we define $\mathcal{X}_e := \mathcal{X} \cap \mathcal{X}(\sigma_e)$ as in Construction 1.5.13. In the same way we define \mathcal{X}_e for those edges of β which are not edges of α . If we consider the edges of α as edges in β , they are mapped into $(\sigma_e^\beta)^\circ$ and we define $\mathcal{X}_e^\beta := \mathcal{X} \cap \mathcal{F}_e^\beta$.

Now we have to define some maps in order to do computations. For each edge $e = \{f_1, f_2\}$ of β_v let as in Construction 1.5.13

$$\text{ev}_e^v := (\text{ev}_{f_2} \times \text{ev}_{f_1}) \circ \text{pr} : \prod_{u \in V_{\beta_v}} \mathcal{N}_u \longrightarrow \mathcal{X}_e^2,$$

where pr denotes the projection onto $\mathcal{M}_{u_1} \times \mathcal{M}_{u_2}$, with u_i incident to f_i for $i = 1, 2$. For each vertex v of α and each edge e of β_v denote by $\tilde{\text{ev}}_e^v$ the composition of ev_e^v with the projection $\text{pr}_v : \prod_{w \in V_\alpha} \prod_{u \in V_{\beta_w}} \mathcal{N}_u \longrightarrow \prod_{u \in V_{\beta_v}} \mathcal{N}_u$. Denote the quotient map for gluing of β_v by

$$q^v : \prod_{u \in V_{\beta_v}} \mathcal{N}_u \longrightarrow \left(\prod_{u \in V_{\beta_v}} \mathcal{N}_u \right) / L_{\beta_v}$$

and let f^v denote the embedding into $\mathcal{M}'_0(\mathbb{R}^m, \Delta_v)$, as in (19). Abbreviate the product maps $\tilde{q} = \prod_v q^v$ as well as $\tilde{f} = \prod_v f^v$. Furthermore, let $\tilde{\text{ev}}_e = \text{ev}_e \circ \tilde{f}$ and $\tilde{\text{ev}}_e = \tilde{\text{ev}}_e \circ \tilde{q}$.

Now we are prepared for the computations:

$$\begin{aligned} \mathcal{U} &:= F_* Q \left[\text{EV}^* \Delta \mathcal{X} \cdot \prod_{w \in V_\alpha} \prod_{u \in V_{\beta_w}} \mathcal{N}_u^\varepsilon \right] \\ &\stackrel{(a)}{=} f_* q \left[\tilde{f}_* \tilde{q} \left[\text{EV}^* \Delta \mathcal{X} \cdot \prod_{w \in V_\alpha} \prod_{u \in V_{\beta_w}} \mathcal{N}_u^\varepsilon \right] \right] \\ &\stackrel{\text{def.}}{=} f_* q \left[\tilde{f}_* \tilde{q} \left[\left[\left(\prod_{e \in E_\alpha} \tilde{\text{ev}}_e^* \Delta \mathcal{X}_e^\beta \right) \cdot \prod_{v \in V_\alpha} \left(\prod_{e \in E_{\beta_v}} (\tilde{\text{ev}}_e^v)^* \Delta \mathcal{X}_e \right) \right] \cdot \prod_{w \in V_\alpha} \prod_{u \in V_{\beta_w}} \mathcal{N}_u^\varepsilon \right] \right] \\ &\stackrel{(b)}{=} f_* q \left[\tilde{f}_* \left[\left(\prod_{e \in E_\alpha} \tilde{\text{ev}}_e^* \Delta \mathcal{X}_e^\beta \right) \cdot \tilde{q} \left[\left[\prod_{v \in V_\alpha} \left(\prod_{e \in E_{\beta_v}} (\tilde{\text{ev}}_e^v)^* \Delta \mathcal{X}_e \right) \right] \cdot \prod_{w \in V_\alpha} \prod_{u \in V_{\beta_w}} \mathcal{N}_u^\varepsilon \right] \right] \right] \\ &\stackrel{(c)}{=} f_* q \left[\left(\prod_{e \in E_\alpha} \text{ev}_e^* \Delta \mathcal{X}_e^\beta \right) \cdot \tilde{f}_* \tilde{q} \left[\left[\prod_{v \in V_\alpha} \left(\prod_{e \in E_{\beta_v}} (\tilde{\text{ev}}_e^v)^* \Delta \mathcal{X}_e \right) \right] \cdot \prod_{w \in V_\alpha} \prod_{u \in V_{\beta_w}} \mathcal{N}_u^\varepsilon \right] \right] \\ &\stackrel{(d)}{=} f_* q \left[\left(\prod_{e \in E_\alpha} \text{ev}_e^* \Delta \mathcal{X}_e \right) \cdot \tilde{f}_* \tilde{q} \left[\prod_{v \in V_\alpha} \left[\left(\prod_{e \in E_{\beta_v}} (\text{ev}_e^v)^* \Delta \mathcal{X}_e \right) \cdot \prod_{u \in V_{\beta_v}} \mathcal{N}_u^\varepsilon \right] \right] \right] \\ &\stackrel{(e)}{=} f_* q \left[\left(\prod_{e \in E_\alpha} \text{ev}_e^* \Delta \mathcal{X}_e \right) \cdot \prod_{v \in V_\alpha} f_*^v q^v \left[\left(\prod_{e \in E_{\beta_v}} (\text{ev}_e^v)^* \Delta \mathcal{X}_e \right) \cdot \prod_{u \in V_{\beta_v}} \mathcal{N}_u^\varepsilon \right] \right] \end{aligned}$$

Equality (a) follows from Lemma 1.3.11, we just have to check that $F \circ Q = f \circ q \circ \tilde{f} \circ \tilde{q}$ holds on the cycle $EV^*(\Delta_{\mathcal{X}}) \cdot \prod_{w \in V_{\alpha}} \prod_{u \in V_{\beta_w}} \mathcal{N}_u$. The map \tilde{q} forgets the gluing points for all edges of β that did not occur in α . The map \tilde{f} measures distances between the leaves of the pieces β_v and computes the barycentre of each of these pieces. Then q forgets the gluing points for the edges inherited from α and f adds all the distances measured by \tilde{f} to the total distances between leaves in α . Furthermore f computes the barycentre of the whole curve. This is the same as F does, while Q forgets all gluing points at once. Also $\dim L_{\alpha} + \dim \prod_v L_{\beta_v} = \dim L_{\beta}$ by counting the number of edges involved. These are exactly the lineality spaces that we mod out by q , \tilde{q} and Q respectively. Hence the premises of Lemma 1.3.11 are satisfied.

Equality (b) follows from Lemma 1.4.7 and equality (c) is an application of the projection formula 1.4.5. For equality (d) we used the choice of $\mathcal{N}_u^{\varepsilon}$ in (21) and Corollary 1.4.10. Furthermore, we apply Lemma 1.4.8 several times. Equality (e) follows from the properties of push forward under a product morphism.

In (17) we defined the local moduli space \mathcal{M}_v of v as the restriction of $\mathcal{M}'_0(\mathcal{X}_v, \Delta_v)$ to the set of curves which are mapped into $\mathcal{X}(\sigma_v)$. Now $|\mathcal{F}_{f'}^{\beta}| \subset \mathcal{X}(\sigma_v)$ and we want to further restrict \mathcal{M}_v to

$$\mathcal{M}_v^{\varepsilon} := \mathcal{M}_v \cap \mathcal{N}'(\beta_v) \cap \bigcap_{f' \in F^v} \text{ev}_{f'}^{-1} |\mathcal{F}_{f'}^{\beta}|.$$

We have $\mathcal{Z}'(\beta_v) = \mathcal{M}'_0(\mathcal{X}_v, \Delta_v) \cap \mathcal{N}'(\beta_v)$ if $\dim \mathcal{M}(\beta_v) \leq \text{vdim}(v)$, as v is a good vertex by assumption. If $\dim \mathcal{M}(\beta_v) > \text{vdim}(v)$ all vertices of β and thus also of β_v , are good by assumption. Therefore we can define a gluing cycle, which then satisfies $[\mathcal{Z}'(\beta_v)] = \emptyset$ as in Corollary 1.5.19. Furthermore $\mathcal{N}'(\beta_v) = \emptyset$ by definition. Hence $\mathcal{Z}'(\beta_v) = \mathcal{M}'_0(\mathcal{X}_v, \Delta_v) \cap \mathcal{N}'(\beta_v)$ holds in every case. From the definition of $\mathcal{Z}'(\beta_v)$ and $\mathcal{M}_v^{\varepsilon}$ we conclude that

$$\mathcal{M}_v^{\varepsilon} = f_* q^v \left[\left(\prod_{e \in E_{\beta_v}} (\text{ev}_e^v)^* \Delta_{\mathcal{X}_e} \right) \cdot \prod_{u \in V_{\beta_v}} \mathcal{N}_u^{\varepsilon} \right].$$

If we use this to continue the above computation, we see that

$$(22) \quad \mathcal{U} = f_* q \left[\left(\prod_{e \in E_{\alpha}} (\text{ev}_e^v)^* \Delta_{\mathcal{X}_e} \right) \cdot \prod_{v \in V_{\alpha}} \mathcal{M}_v^{\varepsilon} \right].$$

By Lemma 1.5.17 $\mathcal{Z}'(\beta)$ contains $\mathcal{M}'(\beta)$ in a central cell. Recall that $(\sigma_e^{\beta})^{\circ}$ is a central cell of \mathcal{F}_e^{β} . Therefore also \mathcal{U} contains $\mathcal{M}'(\beta)$ in a central cell, which can be seen exactly as in the proof of Lemma 1.5.17. Obviously $|\mathcal{Z}(\beta)| = \emptyset$ implies that $|\mathcal{U}| = \emptyset$ and by definition of $\mathcal{Z}(\alpha)$ we obtain $|\mathcal{Z}(\alpha)| \cap \mathcal{M}(\beta) = \emptyset$.

If $|\mathcal{Z}(\beta)| \neq \emptyset$ we conclude that $|\mathcal{U}| \subset |\mathcal{Z}'(\beta)|$ is open, since for each vertex u of β the support $|\mathcal{N}_u^{\varepsilon}|$ is open in $|\mathcal{N}_u|$. Furthermore $\mathcal{M}'(\beta) \subset |\mathcal{U}|$ by the statement about the central cell. By definition $|\mathcal{M}_v^{\varepsilon}| \subset |\mathcal{M}_v|$ is open as well and we see that $|\mathcal{U}|$ is also open in $|\mathcal{Z}'(\alpha)|$. Hence we can restrict to $|\mathcal{U}|$ and obtain $\mathcal{U} = \mathcal{Z}'(\alpha) \cap \mathcal{U}$ from (22). If we define U to be the image of $|\mathcal{U}|$ in $\mathcal{M}'_0(\mathbb{R}^m, \Delta)$, this immediately yields $\mathcal{Z}(\beta) \cap U = \mathcal{Z}(\alpha) \cap U$.

For the "in particular" part of the statement, let $\overline{\mathcal{M}(\beta)} \in \mathcal{M}_0(\mathcal{X}, \Delta)$ be a maximal cell, where β is a resolution of α . Then by Definition 1.5.20 the weight ω_{β} of $\overline{\mathcal{M}(\beta)}$ in $\mathcal{M}_0(\mathcal{X}, \Delta)$ is the weight of $\mathcal{M}(\beta)$ in $\mathcal{Z}(\beta)$.

If $\omega_{\beta} = 0$ then $|\mathcal{Z}(\beta)| = \emptyset$ and hence $|\mathcal{Z}(\alpha)| \cap \mathcal{M}(\beta) = \emptyset$. Let now $\omega_{\beta} \neq 0$ and $\beta \geq \gamma \geq \alpha$. We have $|\mathcal{Z}(\beta)| \neq \emptyset$ and hence there is an open set $\mathcal{M}(\beta) \subset U \subset |\mathcal{Z}(\beta)|$ that is also open in $|\mathcal{Z}(\gamma)|$. In particular $\mathcal{M}(\beta) \subset |\mathcal{Z}(\gamma)| \neq \emptyset$. By the same argument also $\mathcal{M}(\gamma) \subset |\mathcal{Z}(\alpha)| \neq \emptyset$. From Lemma 1.5.17 we obtain $\mathcal{M}(\alpha) \subset |\mathcal{Z}(\alpha)|$. So we conclude

$$|\mathcal{M}_0(\mathcal{X}, \Delta) \cap \mathcal{N}(\alpha)| = |\mathcal{Z}(\alpha)|.$$

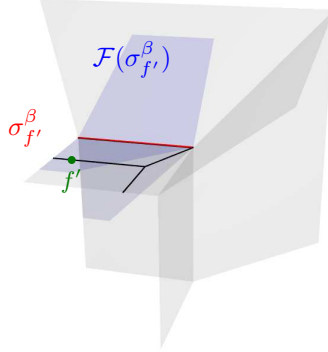

FIGURE 3. Here $\sigma_{f'}$ is the origin and f' is a flag in a contracted edge, indicated as a bold dot. Only a part of a resolution of β is indicated in the picture.

Applying the same arguments again, we obtain an open subset $\mathcal{M}(\beta) \subset U \subset |\mathcal{Z}(\beta)| = \mathcal{M}(\beta)$ such that $\mathcal{Z}(\alpha) \cap U = \mathcal{Z}(\beta) \cap U$. Therefore $\mathcal{Z}(\alpha) \cap \mathcal{M}(\beta) = \mathcal{Z}(\beta)$. Putting this together with the equality of the supports, we obtain $\mathcal{Z}(\alpha) = \mathcal{M}_0(\mathcal{X}, \Delta) \cap \mathcal{N}(\alpha)$.

For a codimension one cell $\overline{\mathcal{M}(\alpha)} \in \mathcal{M}_0(\mathcal{X}, \Delta)$ this implies that $\mathcal{M}_0(\mathcal{X}, \Delta)$ is a tropical variety, because $\mathcal{Z}(\alpha)$ is balanced by construction. \square

Note that in order to show that $\mathcal{M}_0(\mathcal{X}, \Delta)$ is balanced, we actually only needed that the vertices of maximal and codimension one combinatorial types are good.

In order to obtain a tropical variety $\mathcal{M}_0(\mathcal{X}, \Delta)$ from gluing, we will have to show that all vertices are good with respect to our given moduli data. Unfortunately we can do this only if $\dim \mathcal{X} = 1$ and for a few special cases of hypersurfaces up to now, cf. Chapter 3. To simplify this task we state the following two lemmas.

Lemma 1.5.22. *Let (\mathcal{X}', Δ') be a vertex type with $\text{rdim}(\mathcal{X}', \Delta') > 1$, where \mathcal{X}' is a smooth tropical fan which is either a hypersurface or a curve. If all vertices of all non-trivial combinatorial types of degree Δ' curves in \mathcal{X}' are good, then also (\mathcal{X}', Δ') is good.*

PROOF. Let α be a non-trivial combinatorial type of degree Δ' curves in \mathcal{X}' . As all vertices of α are good by assumption, we can apply Theorem 1.5.21, which tells us that $\mathcal{M}_0(\mathcal{X}', \Delta')$ is a tropical variety with $\mathcal{Z}(\alpha) = \mathcal{M}_0(\mathcal{X}', \Delta') \cap \mathcal{N}(\alpha)$. Hence (\mathcal{X}', Δ') is good.

If there is *no* non-trivial combinatorial type, we have $[\mathcal{M}'_0(\mathcal{X}', \Delta')] = [\emptyset]$ by Definition 1.5.10 for dimension reasons. In this case it follows immediately that (\mathcal{X}', Δ') is good. \square

Note that even though the above lemma is very simple, it is also very useful: If one attempts to show that all vertex types are good, one can try to prove this by induction on the classification number. In such an inductive proof, we could assume that all vertices of non-trivial combinatorial types are good by Lemma 1.5.7. Thus, in such an inductive proof, we could restrict to considering vertex types of resolution dimension one. In fact, this will be our approach in the proof of Theorem 3.2.14.

For a vertex type of resolution dimension one we cannot apply Theorem 1.5.21 to prove that it is a good vertex type, as we do not know whether the vertex of the trivial combinatorial type is good or not.

By next lemma we can even restrict to considering virtual dimension one.

Lemma 1.5.23. *Let Δ be a degree of tropical curves in $L_r^{r+1} \times \mathbb{R}^m$. Furthermore denote the projection by $\text{pr} : L_r^{r+1} \times \mathbb{R}^m \rightarrow L_r^{r+1}$ and let $\overline{\Delta} := \text{pr}(\Delta)$. If the vertex type $(L_r^{r+1}, \overline{\Delta})$ is good, then so is $(L_r^{r+1} \times \mathbb{R}^m, \Delta)$.*

PROOF. This proof is similar to the proof of Lemma 1.5.15. We want to abbreviate $\mathcal{X} = L_r^{r+1} \times \mathbb{R}^m$ and $\overline{\mathcal{X}} = L_r^{r+1}$. The projection pr induces a morphism between the moduli spaces

$$Q : \mathcal{M}'_0(\mathbb{R}^{r+1+m}, \Delta) \rightarrow \mathcal{M}'_0(\mathbb{R}^{r+1}, \overline{\Delta}).$$

If we consider the moduli spaces in barycentric coordinates, the morphism Q just becomes $\text{id} \times \text{pr} : \mathcal{M}'_{0,N} \times \mathbb{R}^{r+1+m} \rightarrow \mathcal{M}'_{0,N} \times \mathbb{R}^{r+1}$. Hence this morphism is a quotient morphism with kernel \mathbb{R}^m . In these coordinates we clearly have

$$\mathcal{M}_0(\mathcal{X}, \Delta) = \{\sigma \times \mathbb{R}^m \mid \sigma \in \mathcal{M}_0(\overline{\mathcal{X}}, \overline{\Delta})\}$$

for the polyhedral complexes from Definition 1.5.10.

We want to show by induction on the classification number, that (\mathcal{X}, Δ) is good if $(\overline{\mathcal{X}}, \overline{\Delta})$ is, and $\mathcal{M}_0(\mathcal{X}, \Delta) = \mathcal{M}_0(\overline{\mathcal{X}}, \overline{\Delta}) \times \mathbb{R}^m$ as tropical varieties. If $\text{rdim}(L_{r'}^{q'} \times \mathbb{R}^{m'}, \Delta') = 0$, the claim directly follows from Definition 1.5.9 and Construction 1.5.11. As we saw before, the smallest possible value of a classification number is 3, which belongs to a vertex type of resolution dimension zero.

So let now $\text{rdim}(\mathcal{X}, \Delta) > 0$ and assume $\alpha = (G, (\Delta_v, \sigma_v)_{v \in V_G})$ is a non-trivial combinatorial type of degree Δ curves in \mathcal{X} . Let $\overline{\alpha} = (G, (\overline{\Delta}_v, \text{pr}(\sigma_v))_{v \in V_G})$ be the combinatorial type of degree $\overline{\Delta}$ curves in $\overline{\mathcal{X}}$ that is induced by α , where $\overline{\Delta}_v = \text{pr}(\Delta_v)$. For every vertex v of α , we denote the local moduli space of v in $\overline{\alpha}$ as in (17) by $\mathcal{M}_{\overline{v}}$. As $N_{[(\mathcal{X}, \Delta)]} > N_v$ holds for every vertex v of α by Lemma 1.5.7, we can assume by induction that every vertex v of α is good and $\mathcal{M}_v = \mathcal{M}_{\overline{v}} \times \mathbb{R}^m$ in barycentric coordinates. Here \mathcal{M}_v is the local moduli space of v in α as in (17).

We want to show $Q(\mathcal{Z}'(\alpha)) = \mathcal{Z}'(\overline{\alpha})$. Let f and q be as in Construction 1.5.13 and let \overline{q} denote the quotient by $L_{\overline{\alpha}}$. The projection also induces quotient morphisms

$$Q^v : \mathcal{M}'_0(\mathbb{R}^{r+1+m}, \Delta_v) \rightarrow \mathcal{M}'_0(\mathbb{R}^{r+1}, \overline{\Delta}_v)$$

for the local degrees. As for Q , this morphism just becomes $\text{id} \times \text{pr}$ in barycentric coordinates. The product of the quotients $\prod_v Q^v$ injectively maps L_α to $L_{\overline{\alpha}}$ and hence there is a unique quotient morphism \tilde{Q} such that $\tilde{Q} \circ q = \overline{q} \circ (\prod_v Q^v)$.

For an edge e of α we defined evaluations $\text{ev}_e : \prod_v \mathcal{M}_v \rightarrow \mathcal{X}_e^2$ in Construction 1.5.13. Now consider $e = \{f_1, f_2\}$ as edge of $\overline{\alpha}$ and let $\overline{\mathcal{X}}_e := \text{pr}(\mathcal{X}_e)$. Obviously we have $\mathcal{X}_e = \overline{\mathcal{X}}_e \times \mathbb{R}^m$. We can similarly define an evaluation

$$\overline{\text{ev}}_e := (\text{ev}_{f_1} \times \text{ev}_{f_2}) \circ \text{pr}_e : \prod_v \mathcal{M}_{\overline{v}} \rightarrow \overline{\mathcal{X}}_e^2,$$

where pr_e denotes the projection onto $\mathcal{M}_{\overline{v}_1} \times \mathcal{M}_{\overline{v}_2}$ with v_i incident to f_i for $i = 1, 2$. Furthermore let

$$\hat{\text{ev}}_e := (\text{id}_{\mathbb{R}^m} \times \text{id}_{\mathbb{R}^m}) \circ \text{pr}'_e : \prod_v \mathbb{R}^m \rightarrow (\mathbb{R}^m)^2$$

where pr'_e denotes the projection onto the two copies of \mathbb{R}^m that belong to v_1 and v_2 . We obtain a decomposition

$$(23) \quad \text{ev}_e = \overline{\text{ev}}_e \times \hat{\text{ev}}_e : \prod_v \mathcal{M}_v = \prod_v \mathcal{M}_{\overline{v}} \times \prod_v \mathbb{R}^m \rightarrow \overline{\mathcal{X}}_e^2 \times (\mathbb{R}^m)^2 = \mathcal{X}_e^2.$$

We want to denote the embedding as in (19) of the gluing cycle of $\bar{\alpha}$ into the moduli space $\mathcal{M}'_0(\mathbb{R}^q, \bar{\Delta})$ by \bar{f} . We clearly have $Q \circ f = \bar{f} \circ \tilde{Q}$ and we obtain

$$\begin{aligned} Q(\mathcal{Z}'(\alpha)) &= Qf_*q \left[\left(\prod_e \text{ev}_e^* \Delta_{\mathcal{X}_e} \right) \cdot \prod_v \mathcal{M}_v \right] \\ &\stackrel{(1)}{=} \bar{f}_* \tilde{Q}q \left[\left(\prod_e (\bar{\text{ev}}_e \times \hat{\text{ev}}_e)^* \Delta_{\bar{\mathcal{X}}_e \times \mathbb{R}^m} \right) \cdot \prod_v (\mathcal{M}_{\bar{v}} \times \mathbb{R}^m) \right] \\ &\stackrel{(2)}{=} \bar{f}_* \bar{q} \left(\prod_v Q^v \right) \left[\left[\left(\prod_e \bar{\text{ev}}_e^* \Delta_{\mathcal{X}_e} \right) \cdot \prod_v \mathcal{M}_{\bar{v}} \right] \times \mathcal{M} \right] \\ &\stackrel{(3)}{=} \bar{f}_* \bar{q} \left[\left(\prod_e \bar{\text{ev}}_e^* \Delta_{\bar{\mathcal{X}}_e} \right) \cdot \prod_v \mathcal{M}_{\bar{v}} \right] = \mathcal{Z}'(\bar{\alpha}). \end{aligned}$$

Equality (1) is an application of Lemma 1.3.11 with $Q \circ f = \bar{f} \circ \tilde{Q} \circ \text{id} \circ \text{id}$ and (23). For equality (2) we apply Lemma 1.4.9 and we abbreviate $\mathcal{M} := \left(\prod_e \hat{\text{ev}}_e^* \Delta_{\mathbb{R}^m} \right) \cdot \prod_v \mathbb{R}^m$. Clearly $|\mathcal{M}|$ is a linear subspace of $\prod_v \mathbb{R}^m$ and as the restriction of $\prod_v Q^v$ to $\prod_v \mathcal{M}'_0(\mathbb{R}^q, \Delta_v) \times \mathcal{M}$ has kernel $|\mathcal{M}|$, we can take the quotient by \mathcal{M} via $\prod_v Q^v$ which yields equality (3).

The equality $Q(\mathcal{Z}'(\alpha)) = \mathcal{Z}'(\bar{\alpha})$ applied to every non-trivial combinatorial type α yields an equality $\mathcal{M}_0(\mathcal{X}, \Delta) = \mathcal{M}_0(\bar{\mathcal{X}}, \bar{\Delta}) \times \mathbb{R}^m$ as tropical varieties and that (\mathcal{X}, Δ) is good. This proves the induction hypotheses for (\mathcal{X}, Δ) .

If there is only the trivial combinatorial type τ , then $[\mathcal{M}_0(\mathcal{X}, \Delta)] = \emptyset$ for dimension reasons and hence (\mathcal{X}, Δ) is also good in this case. Furthermore, there is also only the trivial combinatorial type of degree $\bar{\Delta}$ curves in $\bar{\mathcal{X}}$ and therefore also $[\mathcal{M}_0(\bar{\mathcal{X}}, \bar{\Delta})] = [\emptyset]$. So even in this case (\mathcal{X}, Δ) satisfies the induction hypotheses. \square

1.6. Examples of gluing

In this section we will give several examples for the gluing construction 1.5.13, so we will stick to the notation from there.

Example 1.6.1. Let $\mathcal{X} = L_1^2$ be a tropical line in \mathbb{R}^2 and let α be the combinatorial type of arbitrary degree $\Delta = (\delta_1, \dots, \delta_n)$ curves in L_1^2 which is depicted below. Assume that $\text{rdim}(v) = \text{rdim}(v_1) = \text{rdim}(v_2) = 0$.

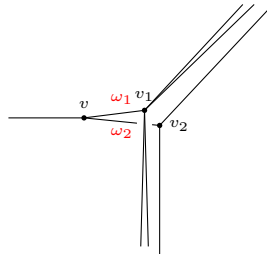

Let $I_i \subset [n]$ be the set of labels of leaves which are incident to the vertex v_i of α , for $i = 1, 2$. Furthermore let the unique leaf incident to v be x_1 and let the edges be given by $e_1 := \{v, v_1\} = \{f_1, f'_1\}$ and $e_2 := \{v, v_2\} = \{f_2, f'_2\}$, where f_i is incident to v for $i = 1, 2$. Let ω_i be the weight of the edge e_i . For any vertex u of α let F^u denote the flags of α which are incident to u . Assume that $\sigma_v = \sigma_1$, the ray generated by the standard basis vector e_1 . By the assumption on the resolution dimension, each local moduli space consists of only one cell, and we can explicitly describe isomorphisms to open polyhedra in some \mathbb{R}^k . \mathcal{M}_v is isomorphic to $\mathbb{R}_{>0}^{F^v} \times \mathbb{R}_{>0} e_1$ with lattice $\mathbb{Z}^{F^v} \times \mathbb{Z} e_1$, where the isomorphism maps $u_{f'}$ (cf. Construction 1.2.9) to the standard basis vector $e_{f'}$ for flags $f' \in F^v$ and the last coordinate is the position of the image of v in $\sigma_1^\circ = \mathbb{R}_{>0} e_1$. Similarly, \mathcal{M}_{v_i} is isomorphic

to $\mathbb{R}_{>0}^{F^{v_i}}$ with lattice $\mathbb{Z}^{F^{v_i}}$ for $i = 1, 2$. We have $\mathcal{X}(\sigma_{e_1}) = \mathcal{X}(\sigma_{e_2}) = \mathbb{R}_{>0}e_1$ and let $\mathcal{X}_{e_i} = \mathcal{X} \cap \mathcal{X}(\sigma_{e_i})$ as in Construction 1.5.13. Therefore we can pull back the diagonal of \mathcal{X}_{e_i} as $\text{ev}_{e_i}^* \min(x - y, 0) = \min(\text{ev}_{f_i} - \text{ev}_{f'_i}, 0)$, where x, y are the coordinates of $\mathcal{X}_{e_i}^2$. This was explained in Construction 1.4.2. Note that the evaluations are linear on $\mathcal{M}_v \times \mathcal{M}_{v_1} \times \mathcal{M}_{v_2}$, therefore we can use Lemma 1.2.9 of [Rau09] to see that $\text{ev}^* \Delta_{\mathcal{X}}(\mathcal{M}_v \times \mathcal{M}_{v_1} \times \mathcal{M}_{v_2})$ is the kernel K of the matrix below. By the same lemma, the weight equals the index of the matrix times the weight of $\mathcal{M}_v \times \mathcal{M}_{v_1} \times \mathcal{M}_{v_2}$, which is $\omega_v \omega_{v_1} \omega_{v_2}$. It is known that the index of a matrix is the absolute value of the greatest common divisor of its maximal minors.

$$\begin{array}{c|cccccc} & e_1 & e_{f_1} & e_{f_2} & e_{f'_1} & e_{f'_2} & \text{rest of the coordinates} \\ \hline \text{ev}_{f_1} - \text{ev}_{f'_1} & 1 & -\omega_1 & 0 & -\omega_1 & 0 & 0 \\ \text{ev}_{f_2} - \text{ev}_{f'_2} & 1 & 0 & -\omega_2 & 0 & -\omega_2 & 0 \end{array}$$

The matrix has three nonzero maximal minors with absolute values ω_1, ω_2 and $\omega_1 \omega_2$. Thus the weight of K equals

$$\omega_\alpha := \text{gcd}(\omega_1, \omega_2) \omega_v \omega_{v_1} \omega_{v_2}.$$

To compute the index of the push-forward, we have to express the embedding f into $\mathcal{M}'_0(\mathbb{R}^m, \Delta)$ (cf. (19)) in a lattice bases of K . The kernel K is $(n + 3)$ -dimensional and spanned by the primitive integral vectors $b_1 = e_{f_1} - e_{f'_1}, b_2 = e_{f_2} - e_{f'_2}$ which also generate the lineality space L_α that we have to mod out, $b = \frac{1}{\text{gcd}(\omega_1, \omega_2)}(\omega_1 \omega_2 e_1 + \omega_2 e_{f_1} + \omega_1 e_{f_2})$ and by e_{x_j} for $j \in [n]$. As usual we denote the map to the quotient by L_α by q . As embedding into $\mathcal{M}_0(\mathbb{R}^2, \Delta)$ (with barycentric coordinates) we obtain

$$\begin{aligned} f \left(\lambda q(b) + \sum_{j=1}^n \mu_j q(e_{x_j}) \right) &= \frac{\lambda}{\text{gcd}(\omega_1, \omega_2)} (\omega_2 v_{I_1} + \omega_1 v_{I_2}) + \sum_{j=1}^n \mu_j u_j \\ &\quad - \lambda \frac{\omega_1 \omega_2}{2 \text{gcd}(\omega_1, \omega_2)} e_1 - \frac{1}{2} \sum_{j=1}^n \mu_j \delta_j \end{aligned}$$

where the vectors v_{I_i} for $i = 1, 2$ and u_j for $j \in [n]$ are as in Construction 1.2.9. One can see that $f(q(K)) = \mathcal{M}'(\alpha)$ and that the lattice $\Lambda_{\mathcal{M}'(\alpha)}$ is generated by

$$\frac{1}{\text{gcd}(\omega_1, \omega_2)} (\omega_2 v_{I_1} + \omega_1 v_{I_2}) - \frac{\omega_1 \omega_2}{2 \text{gcd}(\omega_1, \omega_2)} e_1 \quad \text{and} \quad u_j - \frac{1}{2} \delta_j \quad \text{for } j \in [n].$$

So we see that f is a surjection onto the lattice $\Lambda_{\mathcal{M}'(\alpha)}$ and hence the weight of the cell $\mathcal{M}'(\alpha) = |\mathcal{Z}'(\alpha)|$ in the gluing cycle $\mathcal{Z}'(\alpha)$ is equal to ω_α .

Example 1.6.2. Again, let $\mathcal{X} = L_1^2$ be a tropical line in \mathbb{R}^2 and let α be the combinatorial type of degree Δ curves in L_1^2 which is depicted below. Assume that $\text{rdim}(u) = \text{rdim}(v) = 0$.

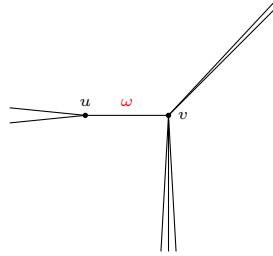

Let the unique edge, which has weight ω , be given by $e := \{f, f'\}$ where the flag f is incident to u and f' to v . We proceed exactly as in the previous example, so let the notation be the same as there, we just omit the index i . This time we only have one pull back of the diagonal. We obtain the weight of the cell $\text{ev}^* \Delta_{\mathcal{X}}(\mathcal{M}_v \times \mathcal{M}_u)$ as the index of the matrix

$$\begin{array}{c|ccc} & e_1 & e_f & e_{f'} & \text{rest of the coordinates} \\ \hline \text{ev}_f - \text{ev}_{f'} & 1 & -\omega & -\omega & 0 \end{array}$$

which is clearly 1, times the weight $\omega_v\omega_u$ of $\mathcal{M}_v \times \mathcal{M}_u$. Computations very similar to those in the previous example show that the push forward under the embedding f into $\mathcal{M}'_0(\mathbb{R}^2, \Delta)$ preserves the weight. Hence we obtain that the cell $\mathcal{M}'(\alpha)$ has the weight

$$\omega_\alpha = \omega_v\omega_u$$

in the gluing cycle $\mathcal{Z}'(\alpha)$.

Example 1.6.3. Consider the degree $\Delta = (e_1, e_2, e_0 + e_3)$ of tropical curves in L_2^3 . We want to check that (L_2^3, Δ) is a good vertex type with respect to suitable moduli data. We have that $\text{vdim}(L_2^3, \Delta) = 1$, and there are three admissible combinatorial types of geometric dimension one. Moving the trivial combinatorial type into direction e_0 yields α_1 , moving it into direction e_3 yields α_2 and moving into direction $e_1 + e_2$ yields α_3 . The combinatorial types α_1 and α_2 only have one vertex each, therefore the gluing cycle is identical to the local moduli space. The local moduli spaces only consist of one cell as the resolution dimension of the vertex is zero in both cases. We want to assign the weight 1 as moduli data to both of them. The picture below shows α_3 .

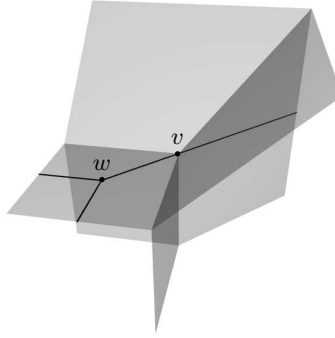

The vertices of α_3 are also of resolution dimension zero and we assign weight 1 to both of them as well. Let $F^v = \{f', x_3\}$ denote the flags incident to v and $F^w = \{x_1, x_2, f\}$ those incident to w . Here the x_j are the leaves of the curves. Then the local moduli space \mathcal{M}_v is isomorphic to $\mathbb{R}_{>0}^{F^v}$ with lattice \mathbb{Z}^{F^v} and \mathcal{M}_w is isomorphic to $\mathbb{R}_{>0}^{F^w} \times \mathbb{R}_{>0}^2$ with lattice $\mathbb{Z}^{F^w} \times \mathbb{Z}^2$. We denote the standard basis vectors by e_f for each flag and the standard basis vectors of the factor $\mathbb{R}_{>0}^2$ by e_1 and e_2 . As before, those copies of $\mathbb{R}_{>0}$ belonging to flags record the length of the leaves and the additional $\mathbb{R}_{>0}^2$ records the position of the image of w in the cone σ_{12} of L_2^3 which is spanned by e_1 and e_2 . As in the previous examples we obtain the weight of $\text{ev}^* \Delta_{\mathcal{X}}(\mathcal{M}_v \times \mathcal{M}_w)$ as the index of the matrix below

$$\begin{array}{c|ccccc} & e_1 & e_2 & e_f & e_{f'} & \text{rest of the coordinates} \\ \hline (\text{ev}_f - \text{ev}_{f'})_1 & 1 & 0 & -1 & -1 & 0 \\ (\text{ev}_f - \text{ev}_{f'})_2 & 0 & 1 & -1 & -1 & 0 \end{array}$$

which can easily be seen to be 1 by computing maximal minors. The indices 1, 2 at the evaluations denote the projection to the corresponding coordinate. As before we can check that push forward under the embedding into $\mathcal{M}'_0(\mathbb{R}^3, \Delta)$ preserves the weight and hence $\mathcal{M}(\alpha_i)$ has weight 1 in the gluing cycle for $i = 1, 2, 3$.

By definition $\mathcal{M}_0(L_2^3, \Delta)$ is a closed fan in $\mathcal{M}_0(\mathbb{R}^3, \Delta) \cong \mathbb{R}^3$ (in barycentric coordinates) consisting of the one dimensional cells $\overline{\mathcal{M}(\alpha_i)}$ for $i = 1, 2, 3$ with weights 1. As the primitive integral generators of these three rays are e_0, e_3 and $e_1 + e_2$, this is balanced and hence the vertex type is good.

Example 1.6.4. Consider the "kitchen hood" surface $\mathcal{X} \subset \mathbb{R}^3$ that consists of four copies of L_2^3 as in the picture below. There is one bounded cell $\sigma \in \mathcal{X}$, namely the square in the middle. We fix coordinates in \mathbb{R}^3 as follows. Let α be the combinatorial type which is depicted in the middle of the picture below. The front vertex v of α is mapped to the

origin and the vertex w in the back is mapped to $(P, P, 0)$ with $P < 0$. If we denote $e_0 = -e_1 - e_2 - e_3$, the combinatorial type α has degree $\Delta = (e_1 + e_2 - e_3, e_3, e_3, e_0)$. As $K_{\mathcal{X}} \cdot \Delta = 2$, we obtain $\dim \mathcal{M}_0(\mathcal{X}, \Delta) = 1$.

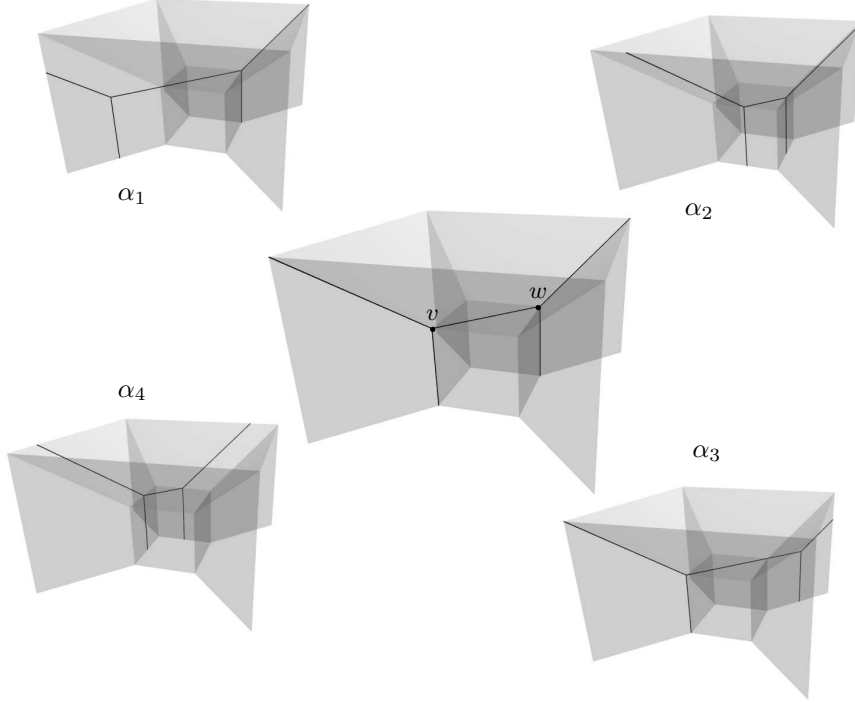

Both vertices v and w are of the same vertex type, which is good by the previous example. We denote by $F^v = \{x_1, x_2, f'\}$ the flags incident to v and by $F^w = \{x_3, x_4, f\}$ those which are incident to w . Here the x_j are the leaves of α . The unique edge is then $e := \{f, f'\}$. The local moduli space \mathcal{M}_v is isomorphic to $L_1^2 \times \mathbb{R}_{>0}^{F^v}$ with lattice $\mathbb{Z}^2 \times \mathbb{Z}^{F^v}$. We denote the coordinates on the ambient vector space $\mathbb{R}^2 \times \mathbb{R}^{F^v}$ by $(x', y', l_{x_1}, l_{x_2}, l_{f'})$. Under this isomorphism, moving the vertex v into direction $-e_1$ corresponds to the coordinate x' and moving into direction $-e_2$ corresponds to y' . To be precise we also have to restrict to the open polyhedron $\{x', y' < P\} \cap \{l_{f'} < P - x'\} \cap \{l_{f'} < P - y'\}$, but this will be unnecessary if we are only interested in the weights on the gluing cycle. In the same way, the local moduli space \mathcal{M}_w is isomorphic to a restriction of $L_1^2 \times \mathbb{R}_{>0}^{F^w}$ to an open polyhedron in the ambient vector space $\mathbb{R}^2 \times \mathbb{R}^{F^w}$. This time we denote the coordinates of the ambient vector space by $(x, y, l_{x_3}, l_{x_4}, l_f)$, where the coordinate x corresponds to moving w from $(P, P, 0)$ into direction e_1 and y corresponds to moving into direction e_2 . With this we obtain for the evaluation morphisms $\text{ev}_f(x, y, l_{x_3}, l_{x_4}, l_f) = (P + x + l_f)e_1 + (P + y + l_f)e_2$ and also $\text{ev}_{f'}(x', y', l_{x_1}, l_{x_2}, l_{f'}) = (-x' - l_{f'})e_1 + (-y' - l_{f'})e_2$. Pulling back two suitable functions cutting out the diagonal of the restriction of \mathcal{X}^2 to $\mathcal{X}(\sigma)^2 = (\sigma^\circ)^2$ (which is locally \mathbb{R}^2) via $\text{ev}_e = \text{ev}_{f'} \times \text{ev}_f$, we obtain that

$$\text{ev}^* \Delta_{\mathcal{X}}(\mathcal{M}_v \times \mathcal{M}_w) = \min(x + x' + l_f + l_{f'}, -P) \cdot \min(y + y' + l_f + l_{f'}, -P) \cdot (\mathcal{M}_v \times \mathcal{M}_w).$$

Computing this intersection product, dividing by the lineality space L_α and embedding this into $\mathcal{M}'_0(\mathbb{R}^3, \Delta)$, we obtain a vertex with four adjacent rays of weight 1 which correspond to the pictures above. This example was computed using the polymake extension `a-tint` of S. Hampe [Ham12]. The picture below indicates the polyhedral complex structure of all $\overline{\mathcal{M}(\gamma)}$ for admissible combinatorial types γ which are resolutions of α . The two combinatorial types α_1 and α_3 can be resolved to a "larger" combinatorial type β which does not occur in $\mathcal{M}_0(\mathcal{X}, \Delta)$. This example also shows that there are in general admissible

combinatorial types of too high dimension. In this case the reason for the existence of admissible combinatorial types of too high dimension is that \mathcal{X} is special. If the cell σ would not be a square, β could not exist.

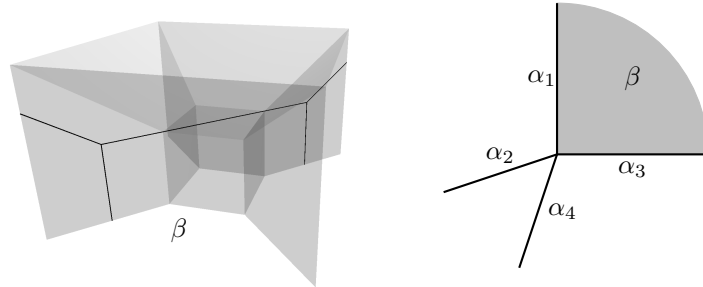

Example 1.6.5. Let $\mathcal{X} = L_2^3$ and $\Delta = (e_0 + e_3, e_0 + e_3, 2e_1, 2e_2)$ be a degree of tropical curves in L_2^3 . We have $\text{vdim}(L_2^3, \Delta) = 1$ and we will show that (L_2^3, Δ) is a good vertex type for a suitable choice of moduli data.

There is an admissible combinatorial type α_1 of geometric dimension one which looks as in the picture below. The red numbers indicate the leaves of the curve which are of weight two. The vertex w is four-valent, hence there are two two-valent vertices v_1 and v_2 mapping to the origin.

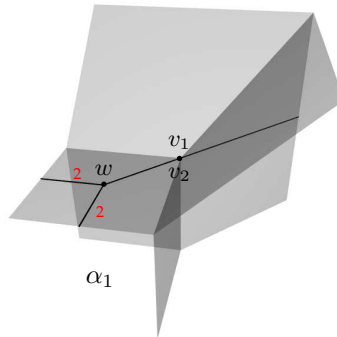

The local moduli space \mathcal{M}_w is isomorphic to a restriction of $\mathcal{M}'_0(\mathbb{R}^2, \Delta_w)$ to an open polyhedral subset. The vertices v_1 and v_2 are of resolution dimension zero, hence they are good. The local moduli spaces \mathcal{M}_{v_i} for $i = 1, 2$ are clearly isomorphic to $\mathbb{R}_{>0}^2$ and we want to equip them with weight 1. Using `a-tint` to compute $\text{ev}^* \Delta_{\mathcal{X}}(\mathcal{M}_w \times \mathcal{M}_{v_1} \times \mathcal{M}_{v_2})$ we see that it consists of only one cell with weight 2 which embeds into $\mathcal{M}'_0(\mathbb{R}^3, \Delta)$ as $\mathcal{M}'(\alpha_1)$, after dividing by the lineality space L_{α_1} . As before, the embedding into $\mathcal{M}'_0(\mathbb{R}^3, \Delta)$ preserves the weight.

Let the combinatorial types α_2 and α_3 of curves of degree Δ in L_2^3 be as in the picture below. Again, the red numbers indicate the edges of weight two. Note that in both pictures w is a three-valent vertex, as in α_3 there emanate two leaves of weight one into the same direction, $e_0 + e_3$. Note that for α_2 and α_3 we have that $\text{rdim}(v) = \text{rdim}(w) = 0$.

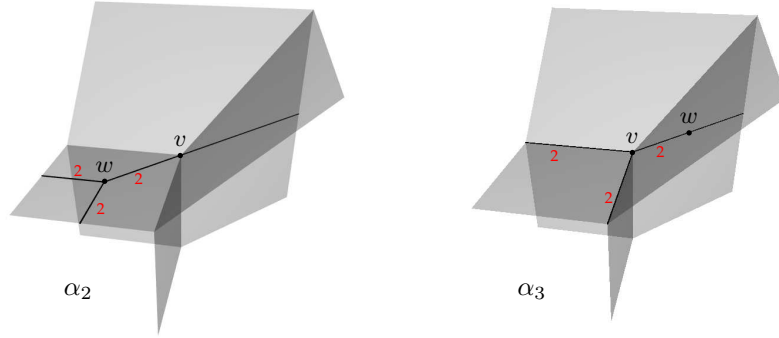

As moduli data we assign weight $-\frac{1}{2}$ to the vertex type $(L_2^3, (2e_1 + 2e_2, e_0 + e_3, e_0 + e_3))$ of v in α_2 and weight $\frac{1}{2}$ to the vertex type $(L_2^3, (2e_1, 2e_2, 2e_0 + 2e_3))$ of v in α_3 , as these are the weights from Conjecture 3.1.7. We explicitly compute the weights in Section 3.4. As in Example 1.6.3 we can see that gluing v to w does not change these weights, and we obtain $\mathcal{M}(\alpha_2)$ with weight $-\frac{1}{2}$ and $\mathcal{M}(\alpha_3)$ with weight $\frac{1}{2}$.

There are two more admissible combinatorial types of degree Δ of geometric dimension one. We can move the trivial combinatorial type into direction e_0 and obtain α_4 , or we can move it into direction e_3 and obtain α_5 . These types both have only one vertex which is of resolution dimension zero. Hence $\mathcal{M}(\alpha_4)$ and $\mathcal{M}(\alpha_5)$ both just occur with the weight of the vertex type of their unique vertex, which we choose as 1.

Let r_i denote the primitive integral generator of the ray $\mathcal{M}(\alpha_i)$ in $\mathcal{M}_0(\mathbb{R}^3, \Delta)$, for $i = 1, \dots, 5$. Using barycentric coordinates we have $r_1 = e_1 + e_2$, $r_2 = v_{12} + e_1 + e_2$, $r_3 = v_{12} + e_0 + e_3$, $r_4 = e_0$ and $r_5 = e_3$. The weighted sum of these vectors is zero, hence $\mathcal{M}_0(L_2^3, \Delta)$ is balanced and (L_2^3, Δ) is a good vertex type.

Example 1.6.6 ($\mathcal{M}_0(\mathcal{X}, \Delta)$ may be reducible). Let $\mathcal{X} = L_2^3$ and let $\Delta = (\delta_1, \delta_2, \delta_3, \delta_4)$ be a degree of tropical curves in L_2^3 , with $\delta_1 = \delta_2 = e_1 + e_2$ and $\delta_3 = \delta_4 = e_0 + e_3$. Then $\text{vdim}(L_2^3, \Delta) = 1$ and we will show that the vertex type (L_2^3, Δ) is good. There are six admissible combinatorial types of degree Δ curves in L_2^3 of geometric dimension one, which we will describe now. We will call the leaves of each combinatorial type x_j for $j = 1, 2, 3, 4$, having direction vector $v(x_j) = \delta_j$ (cf. Definition 1.2.12).

We can move the trivial combinatorial type into direction $e_1 + e_2$ and obtain α_1 and moving it into direction $e_0 + e_3$ yields α_2 . The combinatorial type α_1 has three vertices: w , which is mapped into the relative interior of the cone σ_{12} of L_2^3 , and two vertices v_1 and v_2 which are mapped to the origin. Gluing this combinatorial type works exactly as for the type α_1 of the previous example and yields weight 2 on $\mathcal{M}(\alpha_1)$. For reasons of symmetry, also $\mathcal{M}(\alpha_2)$ is of weight 2.

There is a combinatorial type α_3 with two vertices, w which is mapped into σ_{12}° and adjacent to a vertex v that is mapped to the origin. In this case the vertex v is of vertex type $(L_2^3, (2e_1 + 2e_2, e_0 + e_3, e_0 + e_3))$ and hence of weight $-\frac{1}{2}$. As for α_2 in the previous example we obtain that $\mathcal{M}(\alpha_3)$ has gluing weight $-\frac{1}{2}$. The combinatorial type α_4 also consists of two three-valent vertices v and w . The vertex w is mapped into the relative interior of σ_{03} and again v is mapped to the origin. As before v is of vertex type $(L_2^3, (2e_0 + 2e_3, e_0 + e_3, e_0 + e_3))$. Symmetry yields weight $-\frac{1}{2}$ also for $\mathcal{M}(\alpha_4)$.

The combinatorial type α_5 has two three-valent vertices v and w which are both mapped to the origin. They are adjacent via an edge which is contracted by the map into \mathbb{R}^3 . Here the leaves x_1 and x_3 are adjacent to v and x_2 and x_4 are adjacent to w . The combinatorial type α_6 looks the same, but with x_1 and x_4 adjacent to v and x_2 and x_3 adjacent to w . A computation shows that both combinatorial types have gluing weight -1 .

Let now r_i denote the primitive integral vector on the ray $\mathcal{M}(\alpha_i)$ in $\mathcal{M}_0(\mathbb{R}^3, \Delta)$ in barycentric coordinates, where $i = 1, \dots, 6$. We obtain $r_1 = e_1 + e_2$, $r_2 = e_0 + e_3$, $r_3 = v_{12} + e_1 + e_2$, $r_4 = v_{12} + e_0 + e_3$, $r_5 = v_{13}$ and $r_6 = v_{14}$. The weighted sum of these vectors is zero and hence (L_2^3, Δ) is a good vertex type. Also note that $\overline{\mathcal{M}(\alpha_1)}$ and $\overline{\mathcal{M}(\alpha_2)}$ already form a proper tropical subvariety of $\mathcal{M}_0(L_2^3, \Delta)$, hence this is reducible.

Example 1.6.7. We want to show that every vertex type $(L_0^1 \times \mathbb{R}^m, \Delta)$ is good, where the moduli data are 1 for every occurring vertex type of resolution dimension zero.

We can use Lemma 1.5.23 to reduce this to the case of vertex types (L_0^1, Δ) . Of course we must have $\Delta = (0, \dots, 0)$. For such vertex types we have $N_{[(L_0^1, \Delta)]} = |\Delta|$ for the classification number and $\text{rdim}(L_0^1, \Delta) = |\Delta| - 3$ for the resolution dimension. Clearly the vertex type of resolution dimension zero is good. So consider the vertex type with $1 = \text{rdim}(L_0^1, \Delta) = |\Delta| - 3$, hence $|\Delta| = 4$. Using any sort of coordinates we obtain that $\mathcal{M}_0(\mathbb{R}, \Delta) \cong \mathcal{M}_{0,4} \times \mathbb{R}$ and that $\mathcal{M}_0(L_0^1, \Delta)$ has support $|\mathcal{M}_{0,4}| \times 0$ as polyhedral complex. Consider the combinatorial type α of degree Δ curves in L_0^1 whose graph has two vertices v and w , such that $F^v = \{x_1, x_2, f_1\}$ are the flags of α which are incident to v and $F^w = \{x_3, x_4, f_2\}$ are the flags incident to w . Here the x_j for $j \in [4]$ are the leaves of α . We have $\text{rdim}(v) = \text{rdim}(w) = 0$. Clearly the local moduli spaces are isomorphic to $\mathcal{M}_v \cong \mathbb{R}_{>0}^{F^v}$ with lattice \mathbb{Z}^{F^v} and $\mathcal{M}_w \cong \mathbb{R}_{>0}^{F^w}$ with lattice \mathbb{Z}^{F^w} . We want to assign weight 1 to both of them. The pull back of the diagonal has no influence on the gluing cycle, as L_0^1 is just a point. Let $q : \mathcal{M}_v \times \mathcal{M}_w \rightarrow (\mathcal{M}_v \times \mathcal{M}_w)/L_\alpha$ denote the quotient map. We then obtain the embedding $f : (\mathcal{M}_v \times \mathcal{M}_w)/L_\alpha \rightarrow \mathcal{M}'_{0,4} \times \mathbb{R}$ as $f(q(e_{f_1})) = f(q(e_{f_2})) = v_{12}$ and $f(q(e_{x_j})) = u_j$ for $j \in [4]$, cf. Construction 1.2.9. So push forward along f does not change the weight of the gluing cycle and we conclude that $\mathcal{M}(\alpha)$ occurs with weight one in $\mathcal{Z}(\alpha)$. The same also holds for the other two combinatorial types by symmetry. Hence we obtain an equality of tropical varieties $\mathcal{M}_0(L_0^1, \Delta) = \mathcal{M}_{0,4} \times 0$. This proves that (L_0^1, Δ) is good if it is of resolution dimension one. For all higher resolution dimensions, the claim follows inductively as in the proof of Lemma 1.5.22.

Similarly one can prove that actually $\mathcal{M}_0(L_0^1 \times \mathbb{R}^m, \Delta) \cong \mathcal{M}_0(\mathbb{R}^m, \Delta)$. So the gluing construction recovers the already known moduli spaces of stable maps to \mathbb{R}^m . We only have to consider \mathbb{R}^m as a hypersurface in some larger vector space, as we only defined gluing for hypersurfaces or curves.

Even though the choices of the weights in the above examples might look quite arbitrary, they are all defined by one formula in Conjecture 3.1.7 and those occurring in these examples are computed in Section 3.4.

Relations between algebraic and tropical moduli spaces

We saw in Chapter 1 that even for a tropical fan \mathcal{X} it is already very difficult to find out which combinatorial types of degree Δ curves in \mathcal{X} exist. Examples for growing $|\Delta|$ suggest that there is no feasible purely combinatorial description of these combinatorial types. The aim of this chapter is to describe combinatorial types of degree Δ curves in \mathcal{X} in terms of deformations of algebraic stable maps into a toric variety. Therefore Section 2.1 is dedicated to toric varieties and a description of morphisms into smooth projective toric varieties $X(\Sigma)$. In Section 2.2 we will consider $|\Delta|$ -marked stable maps to a subvariety $Y \subset X(\Sigma)$ which satisfy certain multiplicity conditions to the toric boundary at the marked points. These multiplicity conditions are given by Δ and we will define a stack $W_{\Delta, Y}$ of such stable maps that can be deformed into irreducible curves. We will see that reducible curves in $W_{\Delta, Y}$ correspond to combinatorial types of degree Δ curves in the tropicalisation of Y and that these combinatorial types can be recovered from intersection theoretical properties of $W_{\Delta, Y}$. In Section 2.3 we will compute the expected dimension of $W_{\Delta, Y}$ and show that in general it has a different dimension. We will therefore define a virtual fundamental class of $W_{\Delta, Y}$ which has the expected dimension, in order to benefit from the intersection theoretical description of combinatorial types later on in Chapter 3. We will study the locus of reducible curves in $W_{\Delta, Y}$ in the last section, 2.4.

Throughout this chapter every scheme will be a noetherian scheme over \mathbb{C} and the product of schemes will always be the fibre product over $\text{Spec } \mathbb{C}$. Furthermore projective and affine spaces will always be over \mathbb{C} , unless an index specifies something different.

2.1. Notions from toric geometry

First we want to introduce some basic notions from toric geometry, including intersection theory on toric varieties. We are aiming at a description of morphisms into smooth and complete toric varieties $X(\Sigma)$, which also allows to describe the pull back of the toric boundary divisors nicely. This will be the content of Lemma 2.1.4. We do this, because in the next section we will be interested in stable maps into smooth and projective $X(\Sigma)$, which also satisfy multiplicity conditions to the toric boundary. The main reference for this section is the book [CLS11].

Let Λ be a lattice of rank m and let Σ be a rational fan inside $V = \Lambda \otimes_{\mathbb{Z}} \mathbb{R}$ such that every cone is strictly convex, i.e. it does not contain a non-trivial linear subspace. To such a fan there corresponds a normal and separated toric variety $X(\Sigma)$ of dimension m , cf. Section 3.1 of [CLS11]. We will partially explain this in the next paragraph. For every ray $\rho \in \Sigma(1)$ there is a Weil divisor D_ρ on $X(\Sigma)$. The support of D_ρ is itself a toric variety which corresponds to the fan $\text{Star}_\Sigma(\rho)$. Furthermore, for any cone $\tau \in \Sigma$ we have that $\text{Star}_\Sigma(\tau)$ is the fan corresponding to the toric variety $V(\tau) := \bigcap_{\rho \in \tau(1)} D_\rho$. Recall that $\tau(1)$ is the set of one dimensional faces, i.e. the set of rays that span τ . As a toric variety $V(\tau)$ also contains a dense subtorus which we denote $O(\tau)$. A fan Σ is called *smooth* if each cone is spanned by a part of a \mathbb{Z} -basis of Λ , in particular Σ is then also simplicial. By Theorem 3.1.19 of [CLS11] $X(\Sigma)$ is smooth if and only if Σ is. We call Σ *complete* if its support is $|\Sigma|_{\text{poly}} = V$. By Theorem 3.4.6 of [CLS11] Σ is complete if and only if $X(\Sigma)$ is complete. Furthermore $X(\Sigma)$ is projective if and only if Σ is the normal fan of a polytope, which follows from the

discussion in Section 7.2 of [CLS11]. Therefore we call a fan *projective*, if it is the normal fan of a polytope.

Let us recall a part of the construction of $X(\Sigma)$ from Σ . For a subsemigroup $M \subset \Lambda^\vee$ consider the \mathbb{C} -vector space $\mathbb{C}[M]$ which has the basis $(\chi^\lambda)_{\lambda \in M}$. We can define a \mathbb{C} -algebra structure on $\mathbb{C}[M]$ via $\chi^\lambda \chi^{\lambda'} := \chi^{\lambda+\lambda'}$ for all $\lambda, \lambda' \in M$, as this is a semigroup. For a cone $\sigma \in \Sigma$ we define the dual cone $\sigma^\vee := \{m \in \Lambda^\vee \otimes_{\mathbb{Z}} \mathbb{R} \mid \langle m, x \rangle \geq 0 \text{ for all } x \in \sigma\}$, which yields a semigroup $\sigma^\vee \cap \Lambda^\vee$. The toric variety $X(\Sigma)$ is obtained from gluing affine varieties

$$U_\sigma := \text{Spec } \mathbb{C}[\sigma^\vee \cap \Lambda^\vee]$$

for every cone $\sigma \in \Sigma$. The dense torus of $X(\Sigma)$ is then given by $\text{Spec } \mathbb{C}[\Lambda^\vee]$, which clearly is contained in each U_σ .

In the remaining part of this section we will assume that Σ is a complete and smooth fan of dimension m , even though some results also hold in slightly more general settings.

Now we briefly review intersection theory on toric varieties as discussed in [FS97]. Fulton and Sturmfels defined the group of *Minkowski weights* in order to describe the Chow cohomology $A^{m-k}(X(\Sigma))$. We introduced Minkowski weights in (9). Theorem 2.1 in [FS97] states that $A^{m-k}(X(\Sigma))$ is canonically isomorphic to $M_k(\Sigma)$, we will therefore identify both groups. If $X(\Sigma)$ is smooth, we even have $A^{m-k}(X(\Sigma)) \cong A_k(X(\Sigma))$ where the isomorphism is given by intersecting with the fundamental class. This is the *Poincaré duality* and can be found for example in [Ful98], Corollary 17.4. Furthermore there is the *Kronecker duality* for complete toric varieties $A^k(X(\Sigma)) \cong \text{Hom}(A_k(X(\Sigma)), \mathbb{Z})$ from [FS97], which shows that $A^{m-k}(X(\Sigma))$ and hence also $A_k(X(\Sigma))$ is torsion free. If $X(\Sigma)$ is smooth we can explicitly describe the isomorphism $A_k(X(\Sigma)) \xrightarrow{\sim} M_k(\Sigma)$ as

$$(24) \quad [V] \mapsto \left(\deg \left(\prod_{\rho \in \tau(1)} D_\rho \right) \cdot [V] \right)_\tau$$

by [FS97], Proposition 3.1. Note the similarities to the tropical case (10).

We also want to describe the Picard group, as it is used to define a grading on the Cox ring later on. As Σ is smooth the Weil divisors D_ρ are also Cartier. In fact they generate the Picard group: There is an exact sequence

$$(25) \quad 0 \longrightarrow \Lambda^\vee \xrightarrow{\alpha} \mathbb{Z}^{\Sigma(1)} \xrightarrow{\beta} \text{Pic } X(\Sigma) \longrightarrow 0$$

with homomorphisms given by $\alpha(\lambda) = (\langle \lambda, u_\rho \rangle)_\rho$ and $\beta((a_\rho)_\rho) = \sum_\rho a_\rho D_\rho$, cf. Theorem 4.2.1 of [CLS11]. By [CLS11] Proposition 4.2.5, $\text{Pic } X(\Sigma)$ is a free abelian group and hence the above sequence is even split exact. As χ^λ is in the coordinate ring of the dense torus, it is a rational function on $X(\Sigma)$ and we obtain a principal divisor $\text{div}(\chi^\lambda) = \sum_\rho \langle \lambda, u_\rho \rangle D_\rho$.

Construction 2.1.1 ($X(\Sigma)$ as a geometric quotient). Now we want to describe $X(\Sigma)$ as a quotient of an open subset of $\mathbb{C}^{\Sigma(1)}$ by some group as in [CLS11], Chapter 5. For each $\rho \in \Sigma(1)$ let u_ρ be the primitive integral vector and define

$$(26) \quad G_\Sigma := \left\{ (t_\rho)_\rho \in (\mathbb{C}^*)^{\Sigma(1)} \mid \prod_\rho t_\rho^{\langle \lambda, u_\rho \rangle} = 1 \text{ for all } \lambda \in \Lambda^\vee \right\}.$$

According to [CLS11] Lemma 5.1.1 G_Σ is even a torus, since $A_{m-1}(X(\Sigma))$ is torsion free. Call a subset $C \subset \Sigma(1)$ a *primitive collection* if $C \not\subset \sigma(1)$ for every cone $\sigma \in \Sigma$ and for every proper subset $C' \subsetneq C$ we have $C' \subset \sigma(1)$ for some cone $\sigma \in \Sigma$. Consider the set

$$Z(\Sigma) := \bigcup_C Z(x_\rho \mid \rho \in C) \subset \mathbb{C}^{\Sigma(1)}$$

where the union runs over all primitive collections and the x_ρ denote the coordinate functions on $\mathbb{C}^{\Sigma(1)}$. In Proposition 5.1.9 of [CLS11] a morphism

$$(27) \quad \mathbb{C}^{\Sigma(1)} \setminus Z(\Sigma) \xrightarrow{\pi} X(\Sigma)$$

is constructed, such that the fibres of π are just the orbits of the action of G_Σ on $\mathbb{C}^{\Sigma(1)} \setminus Z(\Sigma)$ by coordinatewise multiplication. So $X(\Sigma)$ is the geometric quotient of $\mathbb{C}^{\Sigma(1)} \setminus Z(\Sigma)$ by G_Σ . This is Theorem 5.1.11 in [CLS11], which even holds for simplicial fans. Note that the divisors D_ρ are given by $\pi(Z(x_\rho))$. The restriction of π and G_Σ fit in a short exact sequence of groups

$$(28) \quad 1 \longrightarrow G_\Sigma \hookrightarrow (\mathbb{C}^*)^{\Sigma(1)} \xrightarrow{\pi} (\mathbb{C}^*)^m \longrightarrow 1$$

which is sort of dual to the sequence (25), cf. §5.1 of [CLS11] for details. Here $(\mathbb{C}^*)^m$ is the set of closed points of the dense torus of $X(\Sigma)$ in a natural way, as $\Lambda^\vee \cong \mathbb{Z}^m$.

The ring $S = \mathbb{C}[x_\rho \mid \rho \in \Sigma(1)]$ is called *Cox ring* of $X(\Sigma)$. It is graded by $\text{Pic } X(\Sigma)$ via $\prod_\rho x_\rho^{a_\rho} \mapsto \sum_\rho a_\rho D_\rho$. For a cone $\sigma \in \Sigma$ we define a monomial $x^{\hat{\sigma}} := \prod_{\rho \notin \sigma(1)} x_\rho$, following the notation from [CLS11]. There is an isomorphism $\text{Spec}(S_{x^{\hat{\sigma}}})_0 \cong U_\sigma$ where the index 0 denotes the degree 0 part of the localised ring. On the coordinate rings, this isomorphism is given by

$$(29) \quad \chi^\lambda \mapsto \prod_\rho x_\rho^{\langle \lambda, u_\rho \rangle} \text{ for } \lambda \in \sigma^\vee \cap \Lambda^\vee.$$

For every line bundle $\mathcal{L} \in \text{Pic } X(\Sigma)$ there is a natural isomorphism $\Gamma(X(\Sigma), \mathcal{L}) \cong S_{\mathcal{L}}$, where $S_{\mathcal{L}}$ denotes the degree \mathcal{L} part of S . In particular x_ρ is a global section of $\mathcal{O}_{X(\Sigma)}(D_\rho)$ in a natural way. These statements can be found in [CLS11], Chapter 5.

We want to describe π from (27) locally, i.e. $\pi|_{\pi^{-1}U_\sigma}$, in terms of coordinate rings. The coordinate ring of $\pi^{-1}U_\sigma$ is just $S_{x^{\hat{\sigma}}}$ and π^* is then given by

$$\mathbb{C}[\sigma^\vee \cap \Lambda^\vee] \longrightarrow S_{x^{\hat{\sigma}}} \text{ with } \chi^\lambda \mapsto \prod_\rho x_\rho^{\langle \lambda, u_\rho \rangle}.$$

This looks the same as above because the degree zero part of that coordinate ring is just the ring of invariants of the G_Σ -action on it, cf. Theorem 5.1.11 of [CLS11].

Now we will deal with morphisms into $X(\Sigma)$. The following definition is from [Cox95].

Definition 2.1.2 (Σ -collections). For a scheme Y a Σ -collection on Y consists of line bundles \mathcal{L}_ρ and global sections $f_\rho \in \Gamma(Y, \mathcal{L}_\rho)$ for every $\rho \in \Sigma(1)$. Additionally, for every $\lambda \in \Lambda^\vee$ we have an isomorphism $c_\lambda : \bigotimes_\rho \mathcal{L}_\rho^{\langle \lambda, u_\rho \rangle} \xrightarrow{\sim} \mathcal{O}_Y$ such that

- (1) (Compatibility) $c_\lambda \otimes c_{\lambda'} = c_{\lambda+\lambda'}$ holds for all $\lambda, \lambda' \in \Lambda^\vee$.
- (2) (Nondegeneracy) Each f_ρ defines a morphism $f_\rho : \mathcal{O}_Y \longrightarrow \mathcal{L}_\rho$ and a dual morphism $f_\rho^* : \mathcal{L}_\rho^{-1} \longrightarrow \mathcal{O}_Y$. We require that the homomorphism

$$f^* := \sum_{\sigma \in \Sigma(m)} \bigotimes_{\rho \notin \sigma(1)} f_\rho^* : \bigoplus_{\sigma \in \Sigma(m)} \bigotimes_{\rho \notin \sigma(1)} \mathcal{L}_\rho^{-1} \longrightarrow \mathcal{O}_Y$$

is surjective.

Two Σ -collections $(\mathcal{L}_\rho, f_\rho, c_\lambda)$ and $(\mathcal{L}'_\rho, f'_\rho, c'_\lambda)$ on Y are *equivalent* if there are isomorphisms $\gamma_\rho : \mathcal{L}_\rho \xrightarrow{\sim} \mathcal{L}'_\rho$ taking f_ρ to f'_ρ and c_λ to c'_λ .

Remark 2.1.3. In this remark we want to show that the nondegeneracy-property from the previous definition can be reformulated as follows: The surjectivity of f^* in the previous definition at a stalk in $P \in Y$ is equivalent to have for each primitive collection C a $\rho \in C$ with $(f_\rho)_P \notin \mathfrak{m}_P(\mathcal{L}_\rho)_P$.

If f_P^* is surjective, we must have a maximal cone $\sigma \in \Sigma(m)$ such that the restricted map $\bigotimes_{\rho \notin \sigma(1)} (\mathcal{L}_\rho^{-1})_P \rightarrow \mathcal{O}_{Y,P}$ is surjective. But this is the case if and only if $(f_\rho)_P \notin \mathfrak{m}_P(\mathcal{L}_\rho)_P$ for all $\rho \notin \sigma(1)$. As no primitive collection can be contained in $\sigma(1)$ the claim follows.

Vice versa, for any point $P \in Y$ the set $B := \{\rho \in \Sigma(1) \mid (f_\rho)_P \in \mathfrak{m}_P(\mathcal{L}_\rho)_P\}$ is by assumption not a primitive collection. But this means that either there is a cone $\sigma \in \Sigma$ such that $B \subset \sigma(1)$ (without loss of generality σ is maximal) or that there is some proper subset $B' \subsetneq B$ with $B' \not\subset \tau(1)$ for all $\tau \in \Sigma$. In the first case we obtain surjectivity by the converse of the above argument. In the second case we obviously must have $|B'| \geq 2$, so we can consider the smallest $N \geq 2$ such that there exists an N -element subset $B'' \subset B'$, which does not span a cone in Σ . Hence B'' is by construction a primitive collection. But by assumption B'' cannot be contained in B , which is a contradiction.

Lemma 2.1.4. *There is a one-to-one correspondence between morphisms $f : Y \rightarrow X(\Sigma)$ and equivalence classes of Σ -collections $(\mathcal{L}_\rho, f_\rho, c_\lambda)$ on Y . Furthermore $\mathcal{L}_\rho \cong f^* \mathcal{O}_{X(\Sigma)}(D_\rho)$ and f_ρ corresponds to $f^* x_\rho$ under this isomorphism.*

PROOF. This is Theorem 1.1 of [Cox95]. As we will need this later on, we want to briefly describe how to obtain a morphism from a given Σ -collection $(\mathcal{L}_\rho, f_\rho, c_\lambda)$. Let $W \subset Y$ be an open subscheme on which all \mathcal{L}_ρ are trivial. Then we can choose isomorphisms $\gamma_\rho : \mathcal{L}_\rho|_W \xrightarrow{\sim} \mathcal{O}_W$ and hence an equivalence $(\mathcal{L}_\rho|_W, f_\rho|_W, c_\lambda) \sim (\mathcal{O}_W, g_\rho, c'_\lambda)$. Now the c'_λ are automorphisms of \mathcal{O}_W and can therefore be regarded as elements in $\Gamma(W, \mathcal{O}_W^*)$. By compatibility we obtain a group homomorphism $c' : \Lambda^\vee \rightarrow \Gamma(W, \mathcal{O}_W^*)$ mapping $\lambda \mapsto c'_\lambda$. As the exact sequence (25) is split, this homomorphism can be extended to a homomorphism $\tilde{c} : \mathbb{Z}^{\Sigma(1)} \rightarrow \Gamma(W, \mathcal{O}_W^*)$. This means there are $\omega_\rho \in \Gamma(W, \mathcal{O}_W^*)$ such that $c'_\lambda = \prod_\rho \omega_\rho^{\langle \lambda, u_\rho \rangle}$ for all $\lambda \in \Lambda^\vee$. So the isomorphisms $\omega_\rho : \mathcal{O}_W \xrightarrow{\sim} \mathcal{O}_W$ give an equivalence $(\mathcal{O}_W, g_\rho, c'_\lambda) \sim (\mathcal{O}_W, h_\rho, \text{id})$.

For each ρ we have that the subscheme $W_\rho = \{P \in W \mid (h_\rho)_P \notin \mathfrak{m}_P\}$ is open, therefore also $W_\sigma := \bigcap_{\rho \notin \sigma(1)} W_\rho$ is open. Then we can define f locally as $f_\sigma^W : W_\sigma \rightarrow U_\sigma \subset X(\Sigma)$ given by the \mathbb{C} -algebra homomorphism

$$(30) \quad \chi^\lambda \mapsto \prod_\rho h_\rho^{\langle \lambda, u_\rho \rangle} \in \Gamma(W_\sigma, \mathcal{O}_{W_\sigma}) \quad \text{for } \lambda \in \sigma^\vee \cap \Lambda^\vee$$

$$\text{and } \mathbb{C} \hookrightarrow \Gamma(W_\sigma, \mathcal{O}_{W_\sigma}).$$

One can check that the local morphisms f_σ^W patch to a morphism $f^W : \bigcup_\sigma W_\sigma \rightarrow X(\Sigma)$ and by the nondegeneracy the W_σ cover all of W . Furthermore this is independent of the choice of the trivialisations γ_ρ and ω_ρ . It is then easy to check that the f^W patch to a morphism $f : Y \rightarrow X(\Sigma)$. The claim about the pull backs of the line bundles follows from Theorem 1.1 and Remark 1.1 of [Cox95]. \square

As in Theorem 2.1 of [Cox95] we now want to see what equivalence classes of Σ -collections can look like on a projective space.

Example 2.1.5 (The case $Y = \mathbb{P}^m$). If \mathfrak{k}/\mathbb{C} is any field extension, then $\text{Pic } \mathbb{P}_{\mathfrak{k}}^m \cong \mathbb{Z}$ via $\mathcal{O}(d) \mapsto d$. So every morphism $f : \mathbb{P}_{\mathfrak{k}}^m \rightarrow X(\Sigma)$ is given by a Σ -collection $(\mathcal{O}(d_\rho), f_\rho, c_\lambda)$, where $f_\rho \in \Gamma(\mathbb{P}_{\mathfrak{k}}^m, \mathcal{O}(d_\rho))$, i.e. it is a homogeneous polynomial with coefficients in \mathfrak{k} . For every $\lambda \in \Lambda^\vee$ the existence of the isomorphism $c_\lambda : \bigotimes_\rho \mathcal{O}(d_\rho)^{\langle \lambda, u_\rho \rangle} \xrightarrow{\sim} \mathcal{O}_{\mathbb{P}_{\mathfrak{k}}^m}$ implies that $\langle \lambda, \sum_\rho d_\rho u_\rho \rangle = 0$. Hence $(d_\rho)_\rho$ is a Minkowski weight on $\Sigma(1)$. Furthermore, for each λ there is also the canonical trivialisation

$$c_\lambda^{\text{can}} : \bigotimes_\rho \mathcal{O}(d_\rho)^{\langle \lambda, u_\rho \rangle} \xrightarrow{\sim} \mathcal{O}(\langle \lambda, \sum_\rho d_\rho u_\rho \rangle) = \mathcal{O}_{\mathbb{P}_{\mathfrak{k}}^m}.$$

We obtain automorphisms $c_\lambda^{can} \circ (c_\lambda)^{-1}$ of $\mathcal{O}_{\mathbb{P}_{\mathfrak{K}}^m}$. As in the proof of Lemma 2.1.4 we obtain $\omega_\rho \in \mathfrak{K}^*$ such that $c_\lambda^{can} = (\prod_\rho \omega_\rho^{\langle \lambda, u_\rho \rangle}) c_\lambda$. So if we replace $F_\rho = \omega_\rho f_\rho$ we obtain an equivalence $(\mathcal{O}(d_\rho), f_\rho, c_\lambda) \sim (\mathcal{O}(d_\rho), F_\rho, c_\lambda^{can})$, cf. Theorem 2.1 of [Cox95]. In the later sections we often want to describe morphisms from a projective space into $X(\Sigma)$. To shorten notation, we will then only talk about a tuple $(F_\rho)_\rho$ of homogeneous polynomials instead of the Σ -collection $(\mathcal{O}(d_\rho), F_\rho, c_\lambda^{can})$, as the bundles and trivialisations are clear. Recall that compatibility in Definition 2.1.2 is only a condition on the trivialisations, while nondegeneracy is only a condition on the global sections. Therefore, in this shorter notation, $(F_\rho)_\rho$ only has to satisfy the nondegeneracy condition.

However, note that $\deg F_\rho = d_\rho$ only holds if $f(\mathbb{P}_{\mathfrak{K}}^m) \not\subset D_\rho$, because otherwise $F_\rho = 0$. Take for example the blow up $\widetilde{\mathbb{P}^2}$ of \mathbb{P}^2 in the intersection of two coordinate lines L_1 and L_2 and let f be the embedding of the exceptional divisor $E \cong \mathbb{P}^1$ into $\widetilde{\mathbb{P}^2}$. In this case we have $f^* \mathcal{O}_{\widetilde{\mathbb{P}^2}}(E) \cong \mathcal{O}(-1)$.

The following two remarks will be useful for computations in the next section. Furthermore, it is sometimes convenient to have a decomposition

$$(31) \quad u_{\rho'} = \sum_{\rho \in \sigma(1)} m(\sigma)_{\rho'}^{\rho'} u_\rho$$

with unique integers $m(\sigma)_{\rho'}^{\rho'}$, for every maximal $\sigma \in \Sigma(m)$ and every $\rho' \in \Sigma(1)$. This exists because the fan Σ is smooth.

Remark 2.1.6 (G_Σ -invariance of Σ -collections). Let $(\mathcal{L}_\rho, f_\rho, c_\lambda)$ be a Σ -collection on the scheme Y . Let $(r_\rho)_\rho \in \Gamma(Y, \mathcal{O}_Y^*)^{\Sigma(1)}$ satisfy $\prod_\rho r_\rho^{\langle \lambda, u_\rho \rangle} = 1$ for all $\lambda \in \Lambda^\vee$, cf. the definition of the torus G_Σ in (26). Multiplication by r_ρ defines an automorphism $\gamma_\rho : \mathcal{L}_\rho \xrightarrow{\sim} \mathcal{L}_{\rho'}$, which takes the section f_ρ to $r_\rho f_\rho$. By assumption the automorphisms γ_ρ induce the identity on $\bigotimes_\rho \mathcal{L}_\rho^{\langle \lambda, u_\rho \rangle}$. Therefore also $(\mathcal{L}_\rho, r_\rho f_\rho, c_\lambda)$ is a Σ -collection, which is equivalent to $(\mathcal{L}_\rho, f_\rho, c_\lambda)$ and hence defines the same morphism to $X(\Sigma)$.

Assume now that also $(s_\rho)_\rho \in \Gamma(Y, \mathcal{O}_Y^*)^{\Sigma(1)}$ and fix a maximal cone $\sigma \in \Sigma(m)$. Then the tuple $(\hat{s}_\rho)_\rho$ with $\hat{s}_\rho = s_\rho^{-1}$ for $\rho \notin \sigma(1)$ and $\hat{s}_\rho = \prod_{\rho' \notin \sigma(1)} s_{\rho'}^{m(\sigma)_{\rho'}^{\rho'}}$ for $\rho \in \sigma(1)$ satisfies the condition from above, where $m(\sigma)_{\rho'}^{\rho'}$ is as in (31). Therefore $(\mathcal{L}_\rho, s_\rho f_\rho, c_\lambda)$ and $(\mathcal{L}_\rho, \hat{s}_\rho s_\rho f_\rho, c_\lambda)$ are equivalent Σ -collections, with $\hat{s}_\rho s_\rho f_\rho = f_\rho$ for $\rho \notin \sigma(1)$ by construction.

Remark 2.1.7 (Extending morphisms into $X(\Sigma)$). Let Y be a scheme and assume we have a two vectors $a, b \in \mathbb{Z}^{\Sigma(1)}$ such that $a - b$ is a Minkowski weight on $\Sigma(1)$. For all $\rho \in \Sigma(1)$ let \mathcal{L}_ρ and \mathcal{M} be line bundles on Y with global sections $f_\rho \in \Gamma(Y, \mathcal{L}_\rho)$ and $g \in \Gamma(Y, \mathcal{M})$. Furthermore assume $(\mathcal{M}^{a_\rho} \otimes \mathcal{L}_\rho, g^{a_\rho} f_\rho, c_\lambda)$ is a Σ -collection on Y , defining a morphism $f : Y \rightarrow X(\Sigma)$. If we denote $U = Y \setminus Z(g)$ then there is an isomorphism $\gamma_\rho : (\mathcal{M}^{a_\rho} \otimes \mathcal{L}_\rho)|_U \xrightarrow{\sim} (\mathcal{M}^{b_\rho} \otimes \mathcal{L}_\rho)|_U$ given by multiplication with $(g|_U)^{b_\rho - a_\rho}$. As $a - b$ is a Minkowski weight, the γ_ρ induce a canonical isomorphism

$$\phi_\lambda : \bigotimes_\rho (\mathcal{M}^{a_\rho} \otimes \mathcal{L}_\rho)|_U^{\langle \lambda, u_\rho \rangle} \xrightarrow{\sim} \bigotimes_\rho (\mathcal{M}^{b_\rho} \otimes \mathcal{L}_\rho)|_U^{\langle \lambda, u_\rho \rangle}.$$

Hence the γ_ρ determine an equivalence between Σ -collections

$$((\mathcal{M}^{a_\rho} \otimes \mathcal{L}_\rho)|_U, (g^{a_\rho} f_\rho)|_U, c_\lambda|_U) \sim ((\mathcal{M}^{b_\rho} \otimes \mathcal{L}_\rho)|_U, (g^{b_\rho} f_\rho)|_U, c_\lambda|_U \circ \phi_\lambda^{-1}).$$

This means they both define the same morphism $h : U \rightarrow X(\Sigma)$ with $f|_U = h$. So we see that we can extend h by f .

Let us consider an easy example. The global sections 1 and t of \mathcal{O}_Y define a morphism $f : Y := \text{Spec } \mathbb{C}[t] \rightarrow \mathbb{P}^1$. The sections t and t^2 give a morphism $h : U = \text{Spec } \mathbb{C}[t]_t \rightarrow \mathbb{P}^1$ and obviously $f|_U = h$, so f extends h .

Remark 2.1.8 (Push forward). Let $f : \mathbb{P}^n \rightarrow X(\Sigma)$ such that the image intersects the dense torus and let $f_\rho := f^*x_\rho$. We want to compute the push forward $f_*[\mathbb{P}^n] \in A_n(X(\Sigma))$. By Example 2.1.5 we know that f_ρ is a homogeneous polynomial of degree d_ρ such that $(d_\rho)_\rho$ is a Minkowski weight on $\Sigma(1)$. Furthermore $f_*[\mathbb{P}^n] = (c_\tau)_\tau \in A_n(X(\Sigma))$ for some Minkowski weight $(c_\tau)_\tau$ on $\Sigma(n)$. We can determine c_τ as degree of an intersection product

$$c_\tau = \deg \left(\prod_{\rho \in \tau(1)} D_\rho \right) \cdot f_*[\mathbb{P}^n].$$

By the projection formula we obtain

$$c_\tau = \deg \left(\prod_{\rho \in \tau(1)} \operatorname{div} f_\rho \right) \cdot [\mathbb{P}^n] = \prod_{\rho \in \tau(1)} \deg f_\rho = \prod_{\rho \in \tau(1)} d_\rho.$$

This coincides with the weights of $\Sigma(n)$ as a marked fan as introduced in [GKM09]. In particular there can only be a morphism f with $\dim f(\mathbb{P}^n) = n$ if $\Sigma(n)$ is a tropical fan with those weights.

Remark 2.1.9 (Morphisms into subvarieties of $X(\Sigma)$). We want to describe a morphism $f : \mathbb{P}_{\mathfrak{k}}^n \rightarrow Y \subset X(\Sigma)$ for a field extension \mathfrak{k}/\mathbb{C} , which factors through a closed subscheme Y of $X(\Sigma)$. We will apply this for the field of Puiseux series later on. The closed subscheme Y comes from an ideal sheaf $\mathcal{I} \hookrightarrow \mathcal{O}_{X(\Sigma)}$ which is associated to a homogeneous ideal $I \subset S$ in the Cox ring, cf. Proposition 6.A.6 of [CLS11]. Furthermore by Proposition 5.3.3 of the same book we have $I_\sigma := \Gamma(U_\sigma, \mathcal{I}) \cong (I_{x^\sigma})_0$ via the isomorphism from (29). We have that $Z(I_\sigma) = Y \cap U_\sigma$.

By Example 2.1.5 we know that f is given by a Σ -collection $(\mathcal{O}(d_\rho), f_\rho, c_\lambda^{can})$. Looking at the proof of Lemma 2.1.4, we can consider the coordinate charts $W_i = \{y_i \neq 0\}$ of $\mathbb{P}_{\mathfrak{k}}^n = \operatorname{Proj} \mathfrak{k}[y_0, \dots, y_n]$. On W_i we then obtain the trivialisation $h_\rho = f_\rho y_i^{-d_\rho}$. So (30) takes the form

$$(32) \quad \chi^\lambda \mapsto \prod_{\xi} h_\rho^{\langle \lambda, u_\rho \rangle} = y_i^{-\langle \lambda, \sum_{\rho} d_\rho u_\rho \rangle} \prod_{\rho} f_\rho^{\langle \lambda, u_\rho \rangle} = \prod_{\rho} f_\rho^{\langle \lambda, u_\rho \rangle}.$$

Let now $F \in I$ be homogeneous. As in the proof of Proposition 5.3.10 of [CLS11], there exist integers b_ρ and k such that $F \prod_{\rho \notin \sigma(1)} x_\rho^{b_\rho - k} \in (I_{x^\sigma})_0$. Using (29) and (32) we see that locally the morphism $f : W_i \cap f^{-1}U_\sigma \rightarrow U_\sigma$ factors through $Y \cap U_\sigma$ if and only if $F((f_\rho)_\rho) \prod_{\rho \notin \sigma(1)} f_\rho^{b_\rho - k} = 0$. By the nondegeneracy of Σ -collections, there is a maximal cone $\sigma \in \Sigma(m)$ such that $\prod_{\rho \notin \sigma(1)} f_\rho \neq 0$ and hence $F((f_\rho)_\rho) = 0$. This implies $F((f_\rho)_\rho) = 0$ for all elements $F \in I$ since I is homogeneous.

So altogether we have that a closed subscheme Y corresponds to a homogeneous ideal $I \subset S$ and a morphism given by $(\mathcal{O}(d_\rho), f_\rho, c_\lambda^{can})$ factors through Y if and only if $F((f_\rho)_\rho) = 0$ for all $F \in I$.

Lemma 2.1.10. *For an integral hypersurface $Y \subset X(\Sigma)$ there is a global section y of $\mathcal{O}_{X(\Sigma)}(Y)$ with $Z(y) = Y$.*

PROOF. As in the previous remark, Y is defined by a homogeneous ideal $I \subset S$ in the Cox ring. As in the proof of [CLS11], Proposition 5.2.4, we obtain such a homogeneous ideal as follows. Consider $\overline{Y} = \overline{\pi^{-1}(Y)} \subset \mathbb{C}^{\Sigma(1)}$, where π denotes the map from (27). Now \overline{Y} is a G_Σ -invariant hypersurface in $\mathbb{C}^{\Sigma(1)}$. Let I be the vanishing ideal of \overline{Y} . The ideal I is principal as it is the ideal of a hypersurface in $\mathbb{C}^{\Sigma(1)}$. Assume $I = \langle y' \rangle$. By the G_Σ -invariance of \overline{Y} , I is homogeneous. Therefore the generator y' also has to be homogeneous of some degree $\mathcal{L} \in \operatorname{Pic} X(\Sigma)$. As mentioned before there is an isomorphism $\Gamma(X(\Sigma), \mathcal{L}) \cong S_{\mathcal{L}}$ to the degree \mathcal{L} part of the Cox ring, cf. Proposition 5.3.7 of [CLS11]. Let y be the preimage of y' under this isomorphism. By construction we have $Z(y) = Y$ and therefore we must have $\mathcal{L} \cong \mathcal{O}_{X(\Sigma)}(Y)$. \square

We conclude this section with some linear algebra that will turn out to be useful when we work with morphisms into toric varieties in the next section.

Definition 2.1.11 (The fan $\tilde{\Sigma}$ and the vector space L_Σ). Let $L_\Sigma \subset \mathbb{R}^{\Sigma(1)}$ denote the vector space spanned by the Minkowski weights on $\Sigma(1)$ and let the standard basis vectors of $\mathbb{R}^{\Sigma(1)}$ be denoted by e_ρ . For the linear map $p_\Sigma : \mathbb{R}^{\Sigma(1)} \rightarrow \mathbb{R}^m$ with $e_\rho \mapsto u_\rho$ we obtain by definition $\ker p_\Sigma = L_\Sigma$. For any cone $\sigma \in \Sigma$ we can define $p_\Sigma^{-1}\sigma =: \tilde{\sigma}$ and the fan $\tilde{\Sigma}$ consisting of these cones. Obviously we have $\tilde{\Sigma}/L_\Sigma = \Sigma$.

Remark 2.1.12. Note that if we consider the exact sequence (28) over the field $K = \overline{\mathbb{R}}((\mathbb{R}))$ from Definition 1.1.1, i.e. we replace \mathbb{C} by K everywhere, taking valuations turns (28) into an exact sequence

$$0 \longrightarrow L_\Sigma \hookrightarrow \mathbb{R}^{\Sigma(1)} \xrightarrow{p_\Sigma} \mathbb{R}^m \longrightarrow 0$$

of vector spaces. The action of G_Σ on $(K^*)^{\Sigma(1)}$ by coordinatewise multiplication then becomes an action of L_Σ on $\mathbb{R}^{\Sigma(1)}$ by coordinatewise addition.

Lemma 2.1.13. For every $x \in \mathbb{Z}^{\Sigma(1)}$ there exists a unique cone $\tau \in \Sigma$ such that

$$x \equiv \sum_{\rho \in \tau(1)} a_\rho e_\rho \pmod{M_1(\Sigma)}$$

with unique $a_\rho \in \mathbb{Z}_{>0}$ for all $\rho \in \tau(1)$.

PROOF. Clearly $p_\Sigma(x) \in \Lambda$ and as Σ is complete, there is some maximal cone $\sigma \in \Sigma(m)$ such that $p_\Sigma(x) \in \sigma$. As Σ is smooth, $(u_\rho)_{\rho \in \sigma(1)}$ is a \mathbb{Z} -basis of Λ and hence there are $a_\rho \in \mathbb{Z}_{\geq 0}$ with $p_\Sigma(x) = \sum_{\rho \in \sigma(1)} a_\rho u_\rho$. Restricting to those ρ with $a_\rho \neq 0$ yields a cone $\tau \leq \sigma$. Obviously $p_\Sigma(x) = \sum_{\rho \in \tau(1)} a_\rho u_\rho = p_\Sigma\left(\sum_{\rho \in \tau(1)} a_\rho e_\rho\right)$ which proves the claim. \square

2.2. Tropical and algebraic moduli spaces

Assume we have a degree Δ of tropical curves, and a smooth projective fan Σ . Then we can consider stable maps into the toric variety $X(\Sigma)$ which satisfy certain multiplicity conditions defined by Δ to the toric boundary. In this section we want to study the relation between deformations of such stable maps and combinatorial types of degree Δ curves in Σ .

First we will briefly review the notion of stable maps and their moduli spaces as they are treated in [BM96]. We will only work with curves of arithmetic *genus zero* in this thesis. Let X be a smooth and projective integral variety and let

$$H_2(X)^+ = \{\alpha \in \text{Hom}_{\mathbb{Z}}(\text{Pic } X, \mathbb{Z}) \mid \alpha(\mathcal{L}) \geq 0 \text{ if } \mathcal{L} \text{ is ample}\}.$$

If $C \xrightarrow{p} S$ is a flat proper morphism and $C \xrightarrow{\pi} X$ any morphism, then we obtain a locally constant function $s \mapsto (\mathcal{L} \mapsto \deg(\pi^* \mathcal{L})_s)$ from S to $\text{Hom}_{\mathbb{Z}}(\text{Pic } X, \mathbb{Z})$, where $(\pi^* \mathcal{L})_s$ denotes the restriction of the line bundle to the fibre of p over s . By abuse of notation we denote this locally constant function $\pi_*[C]$. In the particular case we are interested in, when X is also toric, we have an isomorphism $\text{Hom}_{\mathbb{Z}}(\text{Pic } X, \mathbb{Z}) \cong A_1(X)$ by applying the Kronecker duality from Section 2.1 twice. We will therefore identify both groups later on. Note that if $S = \text{Spec } \mathbb{C}$, then π is proper and $\pi_*[C]$ corresponds to the proper push forward between Chow groups under this isomorphism.

Definition 2.2.1 (Families of stable maps). For any scheme S (the *base* of the family) a tuple $(C, p, S, x_1, \dots, x_n, \pi)$ is called (*family of*) n -*marked stable map(s) of degree β over S* if

- (1) $p : C \rightarrow S$ is a flat and proper morphism whose geometric fibres are reduced, projective, connected curves of genus zero, having only nodes as singularities

- (2) for each $j = 1, \dots, n$, $x_j : S \rightarrow C$ is a morphism with $p \circ x_j = \text{id}_S$ such that the images of the x_j in each geometric fibre of p are distinct smooth points
- (3) $\pi : C \rightarrow X$ is a morphism with $\pi_*[C] = \beta \in H_2(X)^+$
- (4) if Z is an irreducible component of a geometric fibre of p which is mapped to a point by π , Z must have at least three *special points* on it, i.e. nodes or markings.

For $S = \text{Spec } \mathbb{C}$ we omit the base and the morphism to it and just write $(C, x_1, \dots, x_n, \pi)$. Two families $(C', p', S, x'_1, \dots, x'_n, \pi')$ and $(C, p, S, x_1, \dots, x_n, \pi)$ are called *isomorphic* if there is an isomorphism $\phi : C \rightarrow C'$ such that $p = p' \circ \phi$, $\pi = \pi' \circ \phi$ and $x'_j = \phi \circ x_j$ for $j = 1, \dots, n$.

Assume we have a morphism $\varphi : S' \rightarrow S$ and a family $\mathcal{C} := (C, p, S, x_1, \dots, x_n, \pi)$. Define the fibre product $C' := C \times_S S'$ and denote the natural maps $p' : C' \rightarrow S'$ and $\bar{\varphi} : C' \rightarrow C$. For a section x_j we have maps $\text{id}_{S'}$ and $x_j \circ \varphi : S' \rightarrow C$ which induce a morphism $x'_j : S' \rightarrow C'$, which is also a section. With $\pi' := \pi \circ \bar{\varphi}$ we obtain another family $\varphi^* \mathcal{C} := (C', p', S', x'_1, \dots, x'_n, \pi')$, which is called *pull back of the family \mathcal{C} (along φ)*.

We obtain a functor from the category of schemes over \mathbb{C} to the category of sets given by

$$\overline{\mathfrak{M}}_{0,n}(X, \beta)(S) = \{\text{isomorphism classes of } n\text{-marked stable maps of degree } \beta \text{ over } S\}.$$

The functor $\overline{\mathfrak{M}}_{0,n}(X, \beta)$ assigns to a morphism $\varphi : S' \rightarrow S$ a map $[C] \mapsto [\varphi^* \mathcal{C}]$, where the brackets stand for isomorphism classes. This functor is in general not representable by a scheme, i.e. it does not have a fine moduli space.

However, there is a projective variety M of finite type over \mathbb{C} which is a coarse moduli space for this functor. The construction of M is explained in [FP97] with a lot of details. As the simplicial homology $H_2(X, \mathbb{Z})$ is used in this paper rather than $H_2(X)^+$, note that for toric X (over \mathbb{C}) also $H_2(X, \mathbb{Z}) \cong A_1(X)$. A coarse moduli space still admits a morphism $S \rightarrow M$ for each isomorphism class of families of stable maps $(C, p, S, x_1, \dots, x_n, \pi)$, but there is no universal curve over M . To solve this problem, the notion of a *stack* has been introduced. For a brief but good introduction to stacks we refer to Section 7 of [Vis89]. A very detailed reference is [Sta]. To put it very simply, a stack is a category F together with a functor $p_F : F \rightarrow (\text{Sch})$ to the category of schemes over \mathbb{C} which satisfies some additional conditions. The functor p_F is sometimes also called *structure morphism* of the stack. A *morphism* between stacks is then just a functor which is compatible with the structure morphisms. A category can be equipped with something similar to a topology, a so called Grothendieck topology, cf. [Sta] Section 9.6 "Sites". The additional properties of a stack will not be needed here explicitly, but loosely speaking these properties are: We can compare two objects of F locally in a certain Grothendieck topology and we can glue a family of objects in F to one object, if they satisfy a certain kind of cocycle condition. This second property is usually called *descent* in the literature. Furthermore, we should note that every scheme S defines a stack, namely the category of schemes over S .

Definition 2.2.2 (The stack $\overline{M}_{0,n}(X, \beta)$). We denote by $\overline{M}_{0,n}(X, \beta)$ the category whose objects are families of stable maps $(C, p, S, x_1, \dots, x_n, \pi)$ of degree β as above. A morphism from the family $(C, p, S, x_1, \dots, x_n, \pi)$ to $(C', p', S', x'_1, \dots, x'_n, \pi')$ is a pair of morphisms $(\bar{\varphi}, \varphi)$, where $\bar{\varphi} : C \rightarrow C'$ and $\varphi : S \rightarrow S'$ form a Cartesian diagram together with p and p' . Furthermore, they satisfy $\varphi \circ p = p' \circ \bar{\varphi}$, $\pi = \pi' \circ \bar{\varphi}$ and $x'_j \circ \varphi = \bar{\varphi} \circ x_j$ for $1 \leq j \leq n$. The structure morphism of the stack to (Sch) assigns to a family $(C, p, S, x_1, \dots, x_n, \pi)$ just the base S . This stack has been studied in [BM96]. It is a Deligne-Mumford stack which is proper over $\text{Spec } \mathbb{C}$. Let $M_{0,n}(X, \beta)$ denote the open substack of families of stable maps where all fibres of p are smooth. Sometimes it will be convenient to label the marked points by an index set I , different from $[n]$. We will then write $\overline{M}_{0,I}(X, \beta)$ instead of $\overline{M}_{0,n}(X, \beta)$.

Definition 2.2.3 (Evaluation morphism). For each marking x_j there is a morphism of stacks $\text{ev}_j : \overline{M}_{0,n}(X, \beta) \rightarrow X$ which maps a family of stable map $(C, p, S, x_1, \dots, x_n, \pi)$ to the morphism $\pi \circ x_j : S \rightarrow X$. In particular it maps a curve $(C, x_1, \dots, x_n, \pi)$ over $\text{Spec } \mathbb{C}$ to the point $\pi(x_j) \in X$.

The coarse moduli space M of the functor $\overline{\mathfrak{M}}_{0,n}(X, \beta)$ also serves as a moduli space of the stack $\overline{M}_{0,n}(X, \beta)$ in the sense of Vistoli [Vis89] and [Gil84] who introduced intersection theory on stacks. In particular there is a canonical proper morphism $p : \overline{M}_{0,n}(X, \beta) \rightarrow M$ such that every morphism $f : \overline{M}_{0,n}(X, \beta) \rightarrow N$ to a scheme factors through M , i.e. there is some morphism $f' : M \rightarrow N$ with $f = f' \circ p$. This follows immediately from the properties of a coarse moduli space, cf. Section 1.2 of [FP97]. Vistoli proved in [Vis89] that there is a canonical isomorphism $A_k(\overline{M}_{0,n}(X, \beta))_{\mathbb{Q}} \cong A_k(M)_{\mathbb{Q}}$ given by the proper push forward p_* . Therefore we may also perform (almost) all intersection theoretical calculations on M and then carry them over to $\overline{M}_{0,n}(X, \beta)$ afterwards.

Similar to stable maps we can define stable marked curves.

Definition 2.2.4 (Families of stable marked curves and $\overline{M}_{0,n}$). The functor $\overline{\mathfrak{M}}_{0,n}(\text{Spec } \mathbb{C}, 0)$ is representable by a smooth projective scheme $\overline{M}_{0,n}$ of finite type over \mathbb{C} . The closed points of $\overline{M}_{0,n}$ are in bijection to isomorphism classes of *stable marked curves* (C, x_1, \dots, x_n) . The open subscheme of irreducible curves is called $M_{0,n}$. Sometimes it will be convenient to label the marked points by an index set I , different from $[n]$. We will then write $\overline{M}_{0,I}$ instead of $\overline{M}_{0,n}$.

Recall that if $|I| = 4$ we have $\overline{M}_{0,I} \cong \mathbb{P}^1$. For each partition $I = \{i, j\} \sqcup \{k, l\}$ there is a point in $\overline{M}_{0,I}$ which corresponds to a stable curve having two irreducible components with the marked points x_i, x_j on one component and x_k, x_l on the other component. This point yields a Cartier divisor which we will denote $(ij|kl)$.

Definition 2.2.5 (Forgetful morphisms). For a family $(C, p, S, x_1, \dots, x_n, \pi)$ of stable maps there is a stabilising morphism $f : C \rightarrow \tilde{C}$ and a family of stable n -marked curves $(\tilde{C}, \tilde{p}, S, \tilde{x}_1, \dots, \tilde{x}_n)$ with $p = \tilde{p} \circ f$ and $\tilde{x}_i = f \circ x_i$ for $i = 1, \dots, n$, cf. [BM96], Proposition 3.10. As $\overline{M}_{0,n}$ represents the functor of families of n -marked stable maps, this induces a morphism $S \rightarrow \overline{M}_{0,n}$. The *forgetful morphism* $\text{ft} : \overline{M}_{0,n}(X, \beta) \rightarrow \overline{M}_{0,n}$ is then defined as the functor mapping $(C, p, S, x_1, \dots, x_n, \pi)$ to the morphism $S \rightarrow \overline{M}_{0,n}$ from above.

Let $I \subset [n]$ be a subset of the markings. For a family of stable maps $(C, p, S, x_1, \dots, x_n, \pi)$ there is also a stabilising morphism $f' : C \rightarrow C'$ and a stabilised family of I -marked stable maps $(C', p', S, (x'_i)_{i \in I}, \pi')$ such that $p = p' \circ f'$, $\pi = \pi' \circ f'$ and $x'_i = f' \circ x_i$ for $i \in I$, cf. [BM96], Proposition 3.10. The *forgetful morphism* $\text{ft}_I : \overline{M}_{0,n}(X, \beta) \rightarrow \overline{M}_{0,I}(X, \beta)$ then maps $(C, p, S, x_1, \dots, x_n, \pi)$ to $(C', p', S, (x'_i)_{i \in I}, \pi')$.

We also obtain forgetful morphisms $\text{ft}_I : \overline{M}_{0,n}(X, \beta) \rightarrow \overline{M}_{0,I}$, by combining both morphisms from above.

Definition 2.2.6 (Dual graph). Let C be a projective nodal curve with pairwise distinct smooth points $x_1, \dots, x_n \in C$ (marked points) and normalisation $\nu : \tilde{C} \rightarrow C$. The *dual graph* of (C, x_1, \dots, x_n) is the graph G whose vertices are the irreducible components of \tilde{C} . The set of flags of G is the set of preimages under ν of all marked points or nodes on C . The incidence map ∂_G maps a flag to the irreducible component on which it lies. If for a flag f we have $|\nu^{-1}(\nu(f))| = 1$, i.e. it is a marked point, then we define $j_G(f) = f$. If $\nu(f)$ is a node, i.e. $\nu^{-1}(\nu(f)) = \{f, f'\}$, we assign $j_G(f) := f'$.

The picture below shows an example of a marked curve and its dual graph. One can already guess a relation of dual graphs to $M_{0,n}$ from the picture.

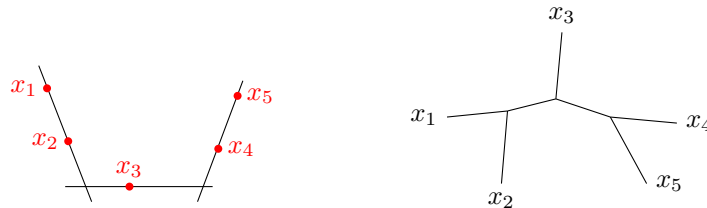

The notion of the dual graph naturally extends to higher genus curves and there are lots of relations between algebraic and tropical moduli spaces of curves, see for example the paper [Cap11]. A relation between dual graphs of stable maps and $\mathcal{M}_0(\mathbb{R}, \Delta)$ will be part of this thesis, cf. Theorem 2.2.18.

For the rest of this section let \mathcal{Y} be a tropical polyhedral complex which is a subfan of a smooth projective fan Σ . Furthermore let $Y \subset X(\Sigma)$ be an integral subvariety such that the tropicalisation of Y (with weights) is \mathcal{Y} .

Definition 2.2.7. A tropical degree $\Delta = (\delta_1, \dots, \delta_n)$ of curves in \mathcal{Y} defines a class $\beta \in A_1(X(\Sigma))$ as follows: As the variety $X(\Sigma)$ is smooth we know that $A_1(X(\Sigma))$ is isomorphic to the group of Minkowski weights on $\Sigma(1)$ so we may define $\beta_\Delta := [\Delta]^{M(\Sigma)}$ as in (10), where we consider Δ as a tropical fan in a canonical way. For the rest of this chapter we want to fix the following notation. Each δ_j lies in some $\sigma_j \in \Sigma$. Then there are unique integers $(\alpha_\rho^j)_\rho \in \mathbb{Z}_{\geq 0}^{\Sigma(1)}$ such that $\alpha_\rho^j = 0$ if $\rho \notin \sigma_j(1)$ and $\delta_j = \sum_\rho \alpha_\rho^j u_\rho$. As before, u_ρ denotes the primitive integral vector of $\rho \in \Sigma(1)$.

Definition 2.2.8 (Quasi-resolutions). For a tropical degree Δ of curves in \mathcal{Y} a *quasi-resolution* of (\mathcal{Y}, Δ) is an equivalence class α of tuples $(G, (\Delta_v, \sigma_v)_{v \in V_G})$ as in Definition 1.5.1 such that:

- G is a graph of genus zero
- $\Delta_v = (\delta_f)_{f \in F^v}$ is a tropical degree and $\sigma_v \in \mathcal{Y}$ a cone for every vertex v of G
- for every vertex v of G the pair $(\mathcal{Y}_v, \Delta_v)$ is a vertex type, where \mathcal{Y}_v is the tropical fan defined in (16)
- for each edge $e = \{f_1, f_2\}$ of G we have $\delta_{f_1} = -\delta_{f_2}$
- for each edge $e = \{v, w\}$ of G the cones σ_v and σ_w are both faces of some cone $\tau_e \in \mathcal{Y}$
- $\Delta = (\delta_f)_{f \in L_G}$, where L_G is the set of leaves of G .

So a quasi-resolution can be viewed as a collection of tropical curve pieces in \mathcal{Y} which can be glued to a tropical curve in \mathbb{R}^m , but inside \mathcal{Y} we can only glue one (maybe more) pair of adjacent vertices at a time. Note that every combinatorial type of degree Δ curves in \mathcal{Y} also defines a quasi-resolution in a natural way. As for combinatorial types of curves in \mathcal{Y} we will write $\alpha = (G, (\Delta_v, \sigma_v)_{v \in V_G})$ for any representative of α .

Example 2.2.9. If $\Delta = (2e_1 + 3e_2, e_0 + e_1, e_0 + 2e_3, e_3, e_0)$, there is a quasi-resolution α of (L_2^3, Δ) which looks as follows. The graph $G = (V, F, j, \partial)$ is given by $V = \{u, v, w\}$ and $F = \{x_1, x_2, x_3, x_4, x_5, f_1, f_2, f_3, f_4\}$ with $F^u = \{x_4, x_5, f_1\}$, $F^v = \{x_1, f_2, f_3\}$ and $F^w = \{x_2, x_3, f_4\}$. Furthermore $j(x_j) = x_j$ for all j and $j(f_1) = f_2$ and $j(f_3) = f_4$. The local degrees are obtained from balancing and we have $\sigma_u = \sigma_1$, the ray spanned by e_1 , $\sigma_v = \sigma_{12}$, the cone spanned by e_1 and e_2 , and $\sigma_w = 0$.

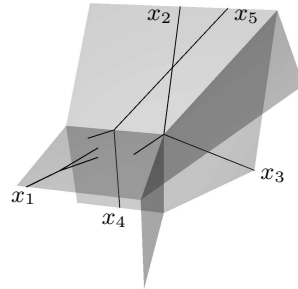

The picture above shows the quasi resolution α . We can see that it is impossible to glue all three pieces of the curve inside L_2^3 at once, cf. Example 2.2.27.

Definition 2.2.10. Let $M_{\Delta, Y}$ denote the substack of $\overline{M}_{0, n}(X(\Sigma), \beta_{\Delta})$ of all families of stable maps $(C, p, S, x_1, \dots, x_n, \pi)$ such that

- (1) $\pi(C) \subset Y$
- (2) $\pi \circ x_j : S \rightarrow D_{\rho}$ for every j and ρ with $\alpha_{\rho}^j > 0$
- (3) $\pi_s^* D_{\rho} - \sum_j \alpha_{\rho}^j x_j = 0 \in A_0(\pi^{-1} D_{\rho})$ for all $\rho \in \Sigma(1)$,

where x_j also denotes the Weil divisor given by the image $x_j(S)$. It is easy to see that $M_{\Delta, Y}$ is a closed substack of $\overline{M}_{0, n}(X(\Sigma), \beta_{\Delta})$, cf. [Ful98] Proposition 11.1. (b) for condition (3).

Remark 2.2.11. Let $(C, x_1, \dots, x_n, \pi) \in M_{\Delta, Y}$ (cf. Remark 1.4 of [Gat02]). Let $Z \subset \pi^{-1} D_{\rho}$ be a one-dimensional connected component (with its reduced scheme structure). Let C^i for $1 \leq i \leq r$ denote the irreducible components of C which are not contained in Z but intersect it, and let m_i denote the multiplicity of $\pi^* D_{\rho}|_{C^i}$ at $C^i \cap Z =: P_i$. We have $A_0(\pi^{-1} D_{\rho}) = \bigoplus_{Z'} A_0(Z')$, where Z' runs over all connected components of $\pi^{-1} D_{\rho}$. The part of $\pi^* D_{\rho} \cdot [C]$ that is supported on Z equals $\sum_{i=1}^r m_i P_i + (\deg(\pi|_Z)^* D_{\rho}) P_1$ in $A_0(Z) \cong \mathbb{Z}$. From property (3) of the previous definition and the projection formula we obtain

$$(33) \quad \deg D_{\rho} \cdot \pi_* [Z] + \sum_{i=1}^r m_i = \sum_{x_j \in Z} \alpha_{\rho}^j.$$

Now we want to see how stable maps in $M_{\Delta, Y}$ are related to quasi-resolutions of (\mathcal{Y}, Δ) . After we proved the following proposition, we will consider an example for the construction from the proof.

Proposition 2.2.12. For every curve $(C, x_1, \dots, x_n, \pi) \in M_{\Delta, Y}$ with normalisation $\nu : \tilde{C} \rightarrow C$ there is a quasi-resolution $\alpha = (G, (\Delta_v, \sigma_v)_{v \in V_G})$ of (\mathcal{Y}, Δ) such that:

- (1) G is isomorphic to the dual graph of (C, x_1, \dots, x_n)
- (2) σ_v is the maximal cone of Σ such that $\pi^v(C^v) \subset V(\sigma_v)$
- (3) for each vertex v of G we have $(C^v, F^v, \pi^v) \in M_{\overline{\Delta}_v, Y_v}$.

Here C^v is the irreducible component of \tilde{C} which corresponds to the vertex v of G via the isomorphism from (1). Furthermore $\pi^v := (\pi \circ \nu)|_{C^v}$, F^v are the flags of the dual graph which are incident to C^v and $Y_v = Y \cap V(\sigma_v)$. The Δ_v are uniquely determined by Δ , G and balancing. In addition $\overline{\Delta}_v$ is the image of Δ_v in $\text{Star}_{\Sigma}(\sigma_v)$.

PROOF. As C is rational, the dual graph G is a tree. Let the cones σ_v be defined as in property (2) above. Let $e = \{C^v, C^w\}$ be an edge of G . By the definition of the dual graph there are special points (flags) $f_v \in C^v$ and $f_w \in C^w$ such that $\nu(f_v) = \nu(f_w)$. This means $\pi^v(f_v) = \pi^w(f_w) \in V(\sigma_v) \cap V(\sigma_w) \neq \emptyset$, hence σ_v and σ_w span a cone $\tau_e \in \Sigma$ and $V(\sigma_v) \cap V(\sigma_w) = V(\tau_e)$.

Assume that $\tau_e \notin \mathcal{Y}$. By Lemma 2.2 of [KP11] Y is already contained in $X(\mathcal{Y}) \hookrightarrow X(\Sigma)$ as the closure of Y intersected with the dense torus in $X(\mathcal{Y})$ is complete. Using the orbit-cone-correspondence (cf. [CLS11] Theorem 3.2.6) we see that $V(\tau_e) \cap X(\mathcal{Y}) = \emptyset$ and therefore $\pi^v(f_v) \notin Y$, which is a contradiction. Hence τ_e and also σ_v and σ_w are in \mathcal{Y} . As this argument applies to any flag, we see that $(\mathcal{Y}_v, \Delta_v)$ is a vertex type.

Now we want to show the claim about the degrees. We want to denote the unique preimage of x_j in \tilde{C} by \tilde{x}_j and furthermore let \tilde{F}^v denote the set of flags f which are incident to C^v and which are not leaves.

First case: $\pi^v(C^v) \not\subset D_{\rho}$. If $f \in F^v$ is a leaf, i.e. $f = \tilde{x}_j$ for some j , we define $m_f^{\rho} := \alpha_{\rho}^j$. If $f \in \tilde{F}^v$ let m_f^{ρ} be the multiplicity of $(\pi|_{\nu(C^v)})^* D_{\rho}$ at the node $\nu(f)$. We obtain

$$(34) \quad (\pi^v)^* D_{\rho} \cdot [C^v] = \sum_{f \in F^v} m_f^{\rho} f \quad \text{and} \quad \deg D_{\rho} \cdot \pi_* [C^v] = \sum_{f \in F^v} m_f^{\rho}.$$

Second case: $\pi^v(C^v) \subset D_\rho$. We want to find a certain representative of $(\pi^v)^* D_\rho \cdot [C^v]$ which is supported on the flags.

Let Z be the connected component of $\pi^{-1}D_\rho$ which contains $\nu(C^v)$ and let Z be equipped with its reduced scheme structure. Then $A_0(Z) \cong \mathbb{Z}$ and as in Remark 2.2.11 we can write $(\pi|_Z)^* D_\rho \cdot [Z] = \sum_{x_j \in Z} \alpha_\rho^j x_j - \sum_{i=1}^r m_i y_i$, where the y_i denote the intersections of Z with the adjacent irreducible components $\nu(C^{v_i})$ and m_i is the multiplicity of $(\pi|_{\nu(C^{v_i})})^* D_\rho$ at y_i . The node y_i has a unique preimage $f_i \in C^{w_i}$ for some vertex with $\nu(C^{w_i}) \subset Z$. For the flags f_i we define $m_{f_i}^\rho := -m_i$.

Let now $Z_0 = Z$ and let Z_{k+1} denote the curve obtained from Z_k by removing those irreducible components which intersect only one other irreducible component of Z_k , and taking the closure in Z_k afterwards. Let $\nu(C^{v_1})$ be such an irreducible component of Z_k , which intersects exactly one other irreducible component $\nu(C^{v_2})$ of Z_k , in the point $\nu(f_1) = \nu(f_2)$. Here $f_i \in C^{v_i}$ for $i = 1, 2$. We then want to define

$$m_{f_1}^\rho := \deg D_\rho \cdot \pi_*^{v_1} [C^{v_1}] - \sum_{f \in F^{v_1} \setminus f_1} m_f^\rho \quad \text{and} \quad m_{f_2}^\rho := -m_{f_1}^\rho.$$

As $A_0(C^{v_1}) \cong \mathbb{Z}$ we obtain equation (34) also in this case.

We can now define $\delta_f := \sum_\rho m_f^\rho u_\rho$ and as the numbers $(\deg D_\rho \cdot \pi_*^v [C^v])_\rho$ are a Minkowski weight on $\Sigma(1)$, we conclude $\sum_{f \in F^v} \delta_f = 0$. By construction we also have $\delta_f = -\delta_{f'}$ if $\{f, f'\}$ is an edge of G . Since G is a tree, we obtain from balancing that $\Delta_v = (\delta_f)_{f \in F^v}$. By the definition of the numbers m_f^ρ it follows directly that $(C^v, F^v, \pi^v) \in M_{\Delta_v, Y_v}$. \square

Example 2.2.13. Now we want to give an example for determining the numbers m_f^ρ from the previous proof. Let Δ be as in Example 2.2.9 and let $H \subset \mathbb{P}^3$ be a hyperplane which tropicalises to L_2^3 . We want to consider a stable map in $M_{\Delta, H}$ which will lead to the quasi-resolution α from that example, but we only want to consider the multiplicities of the stable map to the coordinate hyperplane H_1 of \mathbb{P}^3 . This stable map can also be found as C' in Example 2.2.27. The picture on the left shows the image of the stable map from $M_{\Delta, H}$ in \mathbb{P}^3 , where we did not draw H . The picture on the right shows the normalisation of the abstract curve together with its special points. Their names are chosen as in Example 2.2.9. The red numbers at the special points indicate their multiplicities to H_1 . The green numbers are the m_f^ρ which we want to determine. The map $\pi \circ \nu$, where ν denotes the normalisation, is of degree one on C^u , of degree zero on C^v and of degree two on C^w .

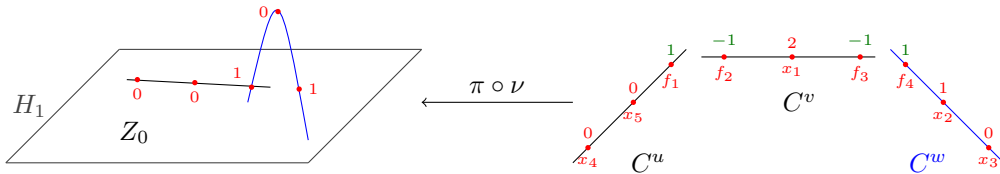

We replace ρ by 1 in the notation from the previous proof as ρ is the ray generated by e_1 . So we want to determine $m_{f_i}^1$ for $i = 1, \dots, 4$. By the first case from the proof we obtain that $m_{f_4}^1 = 1$, as this is the multiplicity of π^w to H_1 at f_4 . In the notation from the previous proof $Z = Z_0 = \nu(C^u \cup C^v)$ is a connected component of $\pi^{-1}H_1$. By the second case, we obtain that $m_{f_3}^1 = -m_{f_4}^1 = -1$. Then $Z_1 = \nu(C^u)$ and $m_{f_2}^1 = \deg \pi^v - m_{f_3}^1 - m_{x_1}^1 = 0 + 1 - 2 = -1$. We obtain $m_{f_1}^1 = -m_{f_2}^1 = 1$. Comparing this to the picture in Example 2.2.9, we see that the numbers at the flags in the right picture above are exactly the coefficients of e_1 in the direction vectors of the flags.

Now we want to focus on combinatorial types instead of quasi-resolutions. On the algebraic side, this can be achieved by only allowing deformations of irreducible curves satisfying the tangency conditions given by Δ .

Definition 2.2.14. Let $W_{\Delta, Y}^\circ$ denote the substack of $\overline{M}_{0, n}(X(\Sigma), \beta_\Delta)$ of all families of stable maps $(C, p, S, x_1, \dots, x_n, \pi)$ such that

- (1) p has smooth fibres
- (2) $\pi(C) \subset Y$
- (3) $\pi_s(C_s) \not\subset D_\rho$ for all $\rho \in \Sigma(1)$ and all $s \in S$
- (4) $\pi \circ x_j : S \rightarrow D_\rho$ for every j and ρ with $\alpha_\rho^j > 0$
- (5) $\pi^* D_\rho - \sum_\rho \alpha_\rho^j x_j = 0 \in A_0(\pi^{-1} D_\rho)$ for all $\rho \in \Sigma(1)$,

where the index s means the restriction to the fibre of p over s and x_j also denotes the Weil divisor $x_j(S)$. Furthermore let $W_{\Delta, Y}$ denote the closure of $W_{\Delta, Y}^\circ$ inside $\overline{M}_{0, n}(X(\Sigma), \beta_\Delta)$ and let $\partial W_{\Delta, Y}$ denote the closed substack of $W_{\Delta, Y}$ of reducible curves and curves mapping into $\bigcup_\rho D_\rho$. It is not hard to see that $W_{\Delta, Y}^\circ$ is a locally closed substack of $\overline{M}_{0, n}(X(\Sigma), \beta_\Delta)$. The condition that curves are contained in a subvariety is a closed condition, so (2) and (4) are closed and (3) is open. Also the condition (5) is closed by [Ful98] Proposition 11.1. (b), while for a proper and flat morphism like p the locus of smooth fibres is open, cf. [Har97], III Exercise 10.2. Obviously $W_{\Delta, Y}$ is a closed substack of $M_{\Delta, Y}$, which is a strict inclusion in general as Example 2.2.27 shows.

We want to describe the stable maps in the boundary $\partial W_{\Delta, Y}$, as they will correspond to combinatorial types of degree Δ curves in \mathcal{Y} by Theorem 2.2.18. To do this, we need to work with étale neighbourhoods of points on smooth curves in the following. Therefore, we fix the notation

$$D_{\mathfrak{K}} := \text{Spec } \mathfrak{K}[[t]] \quad \text{and} \quad D_{\mathfrak{K}}^* := \text{Spec } \mathfrak{K}[[t]]_t$$

for some field extension \mathfrak{K}/\mathbb{C} for the rest of this section. We will usually think of $\mathfrak{K} = \mathbb{C}$, but we will also need the case where \mathfrak{K} is the residue field of the generic point of some codimension one subvariety later on. The closed point of $D_{\mathfrak{K}}$ will always be denoted by \mathfrak{m} . Furthermore, we will need to blow up in order to compute special fibres of families in $W_{\Delta, Y}$.

Remark 2.2.15. If we blow up $D_{\mathfrak{K}} \times \mathbb{A}^1 = \text{Spec } A$, where $A = \mathfrak{K}[[t]][z]$, at the point $(0, 0)$ corresponding to the maximal ideal $I = (t, z)$ we obtain $\text{Proj } S$ where $S = \bigoplus_{d \geq 0} I^d$ and $I^0 = A$. Consider the surjective A -algebra homomorphism $A[y_0, y_1] \xrightarrow{\varphi} S$ which is defined by $y_0 \mapsto t$ and $y_1 \mapsto z$. Then $J := \ker \varphi = (ty_1 - zy_0)$ as the following computation shows. As φ is homogeneous, so is J . The element $ty_1 - zy_0$ is obviously in the kernel. Let $f = \sum_{k=0}^d a_k y_0^{d-k} y_1^k$ be another homogeneous generator of J . We can assume that for $k > 0$ we either have $t \nmid a_k$ or $a_k = 0$. This is because if $a_k = \tilde{a}_k t$ and $k > 0$ we can replace f among the generators of J by $\tilde{f} = f - \tilde{a}_k y_0^{d-k} y_1^{k-1} (ty_1 - zy_0)$ which has then no monomial of the form $y_0^{d-k} y_1^k$. So now we have $0 = \varphi(f) = \sum_{k=0}^d a_k t^{d-k} z^k$ which implies that $t \mid a_d z^d$ and therefore $t \mid a_d$ which means $a_d = 0$. We can cancel t now to obtain $\sum_{k=0}^{d-1} a_k t^{d-1-k} z^k = 0$ and hence also $f_2 = \sum_{k=0}^{d-1} a_k y_0^{d-1-k} y_1^k \in J$ is homogeneous of degree one less. As $f = y_0 f_2$, we can replace f by f_2 as a generator of J . Inductively we obtain that f is already in the ideal $(ty_1 - zy_0)$. Therefore the blowup is isomorphic to the closed subscheme $\text{Proj}(A[y_0, y_1]/J)$ of $\text{Proj } A[y_0, y_1] = \mathbb{P}_A^1 = \mathbb{P}^1 \times D_{\mathfrak{K}} \times \mathbb{A}^1$.

Lemma 2.2.16. *If $C \xrightarrow{p} S$ is a flat family whose geometric fibres are all \mathbb{P}^1 and which admits a section $\sigma : S \rightarrow C$, then every point $s \in S$ has an open neighbourhood U such that $p^{-1}(U)$ is isomorphic to \mathbb{P}_U^1 over U .*

PROOF. This is Proposition 25.3. in [Har10]. That the isomorphism is over U has to be worked out from the proof, but this follows immediately from [Har97], II Proposition 7.12. \square

Lemma 2.2.17. *If we have a family $(C, p, D_{\mathfrak{R}}^*, x_1, \dots, x_n, \pi)$ in $W_{\Delta, Y}^\circ$, this family is isomorphic to a family of the form $(\mathbb{P}_{D_{\mathfrak{R}}^*}^1, \text{pr}, D_{\mathfrak{R}}^*, (1 : \chi_1), \dots, (1 : \chi_n), \tilde{\pi})$. The sections $(1 : \chi_j)$ are defined by elements $\chi_j \in \mathfrak{K}[[t]]$ and the morphism $\tilde{\pi} : \mathbb{P}_{D_{\mathfrak{R}}^*}^1 \rightarrow X(\Sigma)$ is given by a tuple of polynomials $(\pi_\rho)_\rho$ with $\pi_\rho = \beta_\rho \prod_j (\chi_j z_0 - z_1)^{\alpha_\rho^j}$ and $\beta_\rho \in \mathfrak{K}[[t]]$.*

PROOF. It follows immediately from Lemma 2.2.16 and property (1) of Definition 2.2.14 that $C \cong \mathbb{P}_{D_{\mathfrak{R}}^*}^1$ over $D_{\mathfrak{R}}^*$, as $|\Delta| = n > 0$. Let the section x_j correspond to the section \tilde{x}_j via this isomorphism and the morphism π to $\tilde{\pi}$. By the valuative criterion of properness we can extend the sections $\tilde{x}_j : D_{\mathfrak{R}}^* \rightarrow \mathbb{P}_{D_{\mathfrak{R}}^*}^1$ uniquely to sections $\tilde{x}_j : D_{\mathfrak{R}} \rightarrow \mathbb{P}_{D_{\mathfrak{R}}}^1$. Clearly the sections $\tilde{x}_j : D_{\mathfrak{R}}^* \rightarrow \mathbb{P}_{D_{\mathfrak{R}}^*}^1$ are given by two power series $x_j^0, x_j^1 \in \mathfrak{K}[[t]]_t$. We now choose coordinates on $\mathbb{P}_{\mathfrak{R}}^1$ (and hence also on $\mathbb{P}_{D_{\mathfrak{R}}}^1$) such that $\tilde{x}_j(\mathfrak{m}) \neq \infty$ for all $j \in [n]$ holds for the extended sections. This means $\mathbb{P}_{D_{\mathfrak{R}}}^1 = \text{Proj } \mathfrak{K}[[t]]_t[z_0, z_1]$ and if we denote $z = \frac{z_1}{z_0}$, we have that $\tilde{x}_j(\mathfrak{m}) \in U_0 := \text{Spec } \mathfrak{K}[[t]]_t[z]$. If we restrict to $\tilde{x}_j : D_{\mathfrak{R}}^* \rightarrow U_0 \setminus Z(t)$, the section is given by a \mathfrak{K} -algebra homomorphism $\phi_j : \mathfrak{K}[[t]]_t[z] \rightarrow \mathfrak{K}[[t]]_t$ with $\phi_j(t) = t$ and $\phi_j(z) = \frac{x_j^1}{x_j^0} \in \mathfrak{K}[[t]]_t$. But \tilde{x}_j extends to $\tilde{x}_j : D_{\mathfrak{R}} \rightarrow U_0$ by our choice of coordinates, which means we must have $\phi_j(z) \in \mathfrak{K}[[t]]$. So without loss of generality we can assume $x_j^0 = 1$ and $x_j^1 =: \chi_j \in \mathfrak{K}[[t]]$. It follows from Example 2.1.5 and property (3) of Definition 2.2.14 that π is given by homogeneous (in z_0, z_1) polynomials $\pi_\rho \in \mathfrak{K}[[t]]_t[z_0, z_1]$ of degree $d_\rho = \deg \Psi_\rho \cdot \Delta$, where Ψ_ρ is as in Definition 1.3.9 and Δ is the canonical tropical fan curve defined by the tuple Δ . Property (4) of Definition 2.2.14 implies that $\chi_j z_0 - z_1$ is a factor of π_ρ if $\alpha_\rho^j > 0$ while the multiplicity of this factor follows from property (5). Finally we can use Remark 2.1.7 to multiply each π_ρ by a suitable power of t to obtain that the coefficients β_ρ of π_ρ satisfy $\beta_\rho \in \mathfrak{K}[[t]]$. \square

In the situation of the above lemma we will by abuse of notation usually write $x_j = (1 : x_j)$ for the sections $(1 : \chi_j)$.

We want to prove the following theorem later on, which is the analogue of Proposition 2.2.12 for deformations of irreducible curves. The proof is basically just comparing Constructions 2.2.20 and 2.2.21.

Theorem 2.2.18. *For a curve $(C, x_1, \dots, x_n, \pi) \in W_{\Delta, Y}$ with normalisation $\nu : \tilde{C} \rightarrow C$ there is a corresponding combinatorial type $\gamma = (G, (\Delta_v, \sigma_v)_{v \in G})$ of degree Δ curves in \mathcal{Y} such that:*

- (1) *G is isomorphic to the dual graph of (C, x_1, \dots, x_n)*
- (2) *for each vertex v of G , $\sigma_v \in \Sigma$ is the largest cone such that $\pi^v(C^v) \subset V(\sigma_v)$*
- (3) *for each vertex v of G we have $(C^v, F^v, \pi^v) \in W_{\overline{\Delta}_v, Y_v}$.*

Here C^v is the irreducible component of \tilde{C} which corresponds to the vertex v of G via the isomorphism from (1). Furthermore $\pi^v := (\pi \circ \nu)|_{C^v}$, F^v is the set of flags of the dual graph which are incident to C^v and $Y_v = Y \cap V(\sigma_v)$. In addition $\overline{\Delta}_v$ is the image of Δ_v in $\text{Star}_\Sigma(\sigma_v)$.

Note that this correspondence only works in one direction in general. One can also ask, given a combinatorial type of degree Δ curves in \mathcal{Y} , is there an algebraic curve $\mathcal{C} \in \partial W_{\Delta, Y}$ corresponding to it? The answer is no and an example is given in Example 2.2.28. This question is very closely related to the relative tropical inverse problem mentioned in Section 1.1 of Chapter 1. However, if we take Y to be the whole toric variety $X(\Sigma)$, we can find an algebraic curve to every combinatorial type of degree Δ curves in Σ , cf. Corollary 2.4.15.

Definition 2.2.19. Justified by the previous theorem, we want to say that a stable map $(C, x_1, \dots, x_n, \pi) \in W_{\Delta, Y}$ as in Theorem 2.2.18 is of *combinatorial type* γ .

The next two constructions will be essential for the rest of this thesis. First we will describe how to tropicalise a family of stable maps and then how to compute its stable limit. Afterwards we will see an example for both constructions and how they are related.

Construction 2.2.20 (Tropicalising families of stable maps). Assume that we have a family $(C, p, D_{\mathfrak{R}}^*, x'_1, \dots, x'_n, \pi')$ of stable maps in $W_{\Delta, Y}^\circ$. By Lemma 2.2.17 we can find an isomorphism to a family $(\mathbb{P}_{D_{\mathfrak{R}}^*}^1, \text{pr}, D_{\mathfrak{R}}^*, (1 : x_1), \dots, (1 : x_n), \pi)$, where the morphism π is given by a tuple of polynomials $(\pi_\rho)_\rho$ with

$$(35) \quad \pi_\rho = \beta_\rho \prod_j (z_0 x_j - z_1)^{\alpha_\rho^j},$$

$x_j = \sum_{l \geq 0} \gamma_l^j t^l \in \mathfrak{R}[[t]]$ and $\beta_\rho \in \mathfrak{R}[[t]]$. Let $\deg \pi_\rho = d_\rho$. We now want to associate a tropical stable map $(\Gamma, x_1, \dots, x_n, h) \in \mathcal{M}_0(\mathbb{R}^m, \Delta)$ to this family, such that $h(|\Gamma|)$ equals the tropicalisation of $\pi(C)$ if we consider the family as one stable map over the Puiseux series. As usual, this tropicalisation depends on the choice of coordinates, in this case the polynomials π_ρ . However, all choices of coordinates on $\mathbb{P}_{\mathfrak{R}}^1$ as in the proof of Lemma 2.2.17 will define the same tropical stable map as we will see later.

First we should introduce some notation. For $k \in [n]$ let $I(0, k) = [n]$ and let

$$(36) \quad I(m, k) := \{j \in [n] \mid \gamma_l^k = \gamma_l^j \text{ for } l < m\}.$$

We will see in the next construction (2.2.21) that these index sets are in a natural bijection with irreducible components of a semi-stable limit curve and with vertices of the abstract tropical curve Γ that we will construct. We will then call m the *level* of the vertex or component. Recall Definition 2.1.11, as we will first construct a map $\tilde{h} : |\Gamma| \rightarrow \mathbb{R}^{\Sigma(1)}$ and then define h as $p_\Sigma \circ \tilde{h}$.

The morphism π factors through the subvariety $Y \subset X(\Sigma)$, which is given by a homogeneous ideal in the Cox ring $I \subset S = \mathbb{C}[x_\rho \mid \rho \in \Sigma(1)]$. Then for any $F \in I$ we have $F((\beta_\rho \prod_j (z_0 x_j - z_1)^{\alpha_\rho^j})_\rho) = 0$ as in Remark 2.1.9. The field $K = \overline{\mathfrak{R}}((\mathbb{R}))$ is a field extension of $\mathfrak{R}[[t]]_t$ and we can define a map $\pi_K : K \setminus \{x_1, \dots, x_n\} \rightarrow (K^*)^{\Sigma(1)}$ using our polynomials

$$(37) \quad \pi_K(z) := \left(\beta_\rho \prod_j (x_j - z)^{\alpha_\rho^j} \right)_\rho.$$

So we consider our family of stable maps as one stable map over the field K . Clearly π_K factors through the subvariety $Y_K := Z(IK[x^\pm]) \subset K^{\Sigma(1)}$, where $K[x^\pm]$ is the ring of Laurent polynomials in $(x_\rho)_{\rho \in \Sigma(1)}$. Then we can compute the tropicalisation of the image of π_K by taking componentwise valuation, denoted by v . We obtain a tropical curve which automatically lies inside $\text{trop}(Y_K \cap (K^*)^{\Sigma(1)}) = p_\Sigma^{-1}|\mathcal{Y}|$, which is the support of the subfan $\tilde{\mathcal{Y}} = p_\Sigma^{-1}\mathcal{Y}$ of $\tilde{\Sigma}$, cf. Remark 2.1.12. Recall that p_Σ has kernel L_Σ , which is the tropicalisation of the torus G_Σ .

We will construct $(\Gamma, x_1, \dots, x_n, \tilde{h})$ by computing $v(\pi_K(z))$ from (37) for suitably many $z \in K$. This will obviously be contained in $|\tilde{\mathcal{Y}}|$. We will construct Γ as a metric graph as in Definition 1.2.2 by inductively gluing $|\Gamma|$ from intervals. To keep notation short(er) we will not construct the underlying graph of Γ explicitly. However, the underlying graph will be clear, as a closed interval yields one edge, two flags and two vertices, while a half closed interval yields one flag and one vertex. In the following we want to write $X_j := \sum_\rho \alpha_\rho^j e_\rho \in \mathbb{R}^{\Sigma(1)}$, where the e_ρ denote the standard basis.

LEVEL 0: Let $z \in K$ with $v(z) < 0$. As $v(x_j) \geq 0$ for all j we have that $v(x_j - z) = v(z)$ for all j . This gives the valuation $v(\pi_K(z)) = (v(\beta_\rho) + d_\rho v(z))_\rho$, so we obtain just the point $(v(\beta_\rho))_\rho$ modulo L_Σ . Therefore, we start our construction with one vertex $V(0)$ of Γ and we define \tilde{h} of $V(0)$ as $(v(\beta_\rho))_\rho$.

LEVEL m : For $k \in [n]$ let $V(m-1, k)$ be a level $m-1$ vertex of Γ , where $V(0, k) = V(0)$. Then the sets $I(m, i)$ for $i \in I(m-1, k)$ are a partition of $I(m-1, k)$. We want to distinguish between $|I(m, i)| > 1$ and $|I(m, i)| = 1$.

If $|I(m, i)| > 1$, we want to glue a copy of $[0, 1]$ to $|\Gamma|$ at $V(m-1, k)$ such that 0 gets identified with $V(m-1, k)$ and 1 becomes the next vertex $V(m, i)$ of Γ . We define the map \tilde{h} on the interval (now a bounded edge of Γ) as

$$(38) \quad [0, 1] \ni t \mapsto \tilde{h}(V(m-1, k)) + t \sum_{j \in I(m, i)} X_j.$$

If $|I(m, i)| = 1$ and there is a cone $\tilde{\sigma} \in \tilde{\Sigma}$ such that $\tilde{h}(V(m-1, k)) + tX_i \in \tilde{\sigma}$ for all $t > 0$, we glue the interval $[0, \infty)$ with 0 to $|\Gamma|$ at $V(m-1, k)$. Then we define \tilde{h} as

$$[0, \infty) \ni t \mapsto \tilde{h}(V(m-1, k)) + tX_i.$$

The interval $[0, \infty)$ is now a leaf of Γ , which we want to call x_i by abuse of notation. If we only have $|I(m, i)| = 1$ and the above condition is not satisfied, we glue a copy of $[0, 1]$ with 0 to $|\Gamma|$ at $V(m-1, k)$ and 1 becomes the new vertex $V(m, i)$ of Γ . We then define the map \tilde{h} as in (38).

So now we have an n -marked abstract tropical curve Γ and as a next step we want to show $\tilde{h}(|\Gamma|) = \mathbf{v}(\pi_K(K \setminus \{x_1, \dots, x_n\}))$.

To compute the valuation we pick $z_\eta = \gamma_0^i + \dots + \gamma_{m-1}^i t^{m-1} + c_\eta t^\eta + \sum_{\varepsilon > \eta} c_\varepsilon t^\varepsilon \in K$ such that $\mathbf{v}(x_j - z_\eta) = \eta \in (m-1, m)$ for $j \in I(m, i)$. Then $\mathbf{v}(x_j - z_\eta) = l$ for $j \in I(l, i) \setminus I(l+1, i)$ and $l = 0, \dots, m-1$ by definition. We conclude that

$$\mathbf{v}(\pi_K(z_\eta)) = \left(\mathbf{v}(\beta_\rho) + \left(\sum_{l=1}^{m-1} \sum_{j \in I(l, i)} \alpha_\rho^j \right) + (\eta - m + 1) \sum_{j \in I(m, i)} \alpha_\rho^j \right)_\rho$$

and we can assume that $\tilde{h}(V(m-1, i)) = \left(\mathbf{v}(\beta_\rho) + \left(\sum_{l=1}^{m-1} \sum_{j \in I(l, i)} \alpha_\rho^j \right) \right)_\rho$ by induction on m . So we can rewrite the above formula as

$$\mathbf{v}(\pi_K(z_\eta)) = \tilde{h}(V(m-1, i)) + \lambda \sum_{j \in I(m, i)} X_j, \quad \text{where } \lambda = \eta - m + 1 \in (0, 1)$$

which clearly coincides with \tilde{h} on the edge between $V(m-1, i)$ and $V(m, i)$ for η varying between $m-1$ and m .

This construction yields a tropical stable map $(\Gamma, x_1, \dots, x_n, h)$ with $h := p_\Sigma \circ \tilde{h}$, which we want to denote $\text{trop}(\pi, x_1, \dots, x_n)$. For now we want to denote the underlying graph of Γ that is obtained from the construction by $G(\Gamma)$. Then h maps all vertices of $G(\Gamma)$ to lattice points and $h(|\Gamma|) \subset |\mathcal{Y}|$. We want to divide the two-valent vertices of $G(\Gamma)$ into two classes. Let $V(m, k)$ be a two-valent vertex such that $h(V(m, k)) \in \tau^\circ$ for $\tau \in \Sigma$. We then call $V(m, k)$ an I -vertex if it is an isolated point of $h^{-1}(\tau)$ in $|\Gamma|$ and an S -vertex else. Here I stands for intersection and S for superfluous, as I -vertices are those points where the image of the abstract tropical curve Γ intersects a cone of lower dimension, and S -vertices are of no tropical importance but just for bookkeeping during the computation of stable limit curves in the next construction. Also note that if we "delete" the S -vertices from $G(\Gamma)$ we obtain the graph of a combinatorial type of degree Δ curves in \mathcal{Y} .

We want to conclude this construction with a short explanation why it is independent of a choice of coordinates as in the proof of Lemma 2.2.17. The coordinates chosen there are unique up to the action of $PSL_2(\mathbb{R})$. So if we choose different coordinates we obtain

$$(1 : x_j) \begin{pmatrix} 1 & \beta \\ \gamma & \delta \end{pmatrix} = \left(1 : \frac{\beta + \delta x_j}{1 + \gamma x_j} \right) =: (1 : x'_j)$$

for the sections in the new coordinates. What we need to show is that the sets $I(m, k)$ defined by the transformed sections x'_j are the same as those defined by the sections x_j . Expanding the expression $x'_j = (\beta + \delta x_j) \sum_{l \geq 0} (-\gamma x_j)^l$ we see that the coefficient of t^m in x'_j is $(\delta - \beta\gamma)\gamma_m^j + p(\gamma_0^j, \dots, \gamma_{m-1}^j, \beta, \gamma, \delta)$ for some polynomial p . Hence the coefficients of

x_j and x_k coincide up to order $m - 1$ if and only if those of x'_j and x'_k do. This means the transformed sections yield the same sets $I(m, k)$ as the original ones and therefore also the same tropical stable map.

Construction 2.2.21 (Computing stable limits). Assume that we have a family of stable maps $(\mathbb{P}_{D_{\mathfrak{R}}}^1, \text{pr}, D_{\mathfrak{R}}^*, x_1, \dots, x_n, \pi)$ with sections $x_j = (1 : x_j) : D_{\mathfrak{R}}^* \rightarrow \mathbb{P}_{D_{\mathfrak{R}}}^1$ for $j \in [n]$ where $x_j \in \mathfrak{R}[[t]]$ by abuse of notation. The morphism $\pi : \mathbb{P}_{D_{\mathfrak{R}}}^1 \rightarrow X(\Sigma)$ shall be given by a tuple of polynomials $(\pi_\rho)_\rho$ with

$$(39) \quad \pi_\rho = \beta_\rho \prod_j (z_0 x_j - z_1)^{\alpha_\rho^j}$$

and also $\beta_\rho \in \mathfrak{R}[[t]]$. We now want to determine the stable limit of this family, i.e. we want to find a family of stable maps $(\mathcal{C}, p, D_{\mathfrak{R}}, x_1, \dots, x_n, \pi)$ which restricts to the given family on $D_{\mathfrak{R}}^*$. Note that this might be impossible without performing a finite base change first. The fibre over \mathfrak{m} will be called the limit curve of the family. We will use the tropicalisation of the family as a tool in the following computations.

Let $D_{\mathfrak{R}}^* \xrightarrow{\varphi_b} D_{\mathfrak{R}}^*$ be induced by the \mathfrak{R} -algebra homomorphism $t \mapsto t^b$ for some $b \in \mathbb{N}$. Then the pull back family is also $\text{pr} : \mathbb{P}_{D_{\mathfrak{R}}}^1 \rightarrow D_{\mathfrak{R}}^*$ with the sections $(1 : x_j(t^b))$ and the map $\pi \circ (\text{id} \times \varphi_b)$. So all the base change does is replacing each t by t^b in π_ρ . Reviewing Construction 2.2.20, it is not hard to see that

$$\text{trop}(\pi \circ (\text{id} \times \varphi_b), x_1 \circ \varphi_b, \dots, x_n \circ \varphi_b) = b \text{trop}(\pi, x_1, \dots, x_n)$$

holds in $\mathcal{M}_0(\mathbb{R}^m, \Delta) \cong \mathcal{M}_{0,n} \times \mathbb{R}^m$ for any choice of coordinates.

Let $\text{trop}(\pi \circ (\text{id} \times \varphi_b), x_1 \circ \varphi_b, \dots, x_n \circ \varphi_b) =: (\Gamma_b, x_1, \dots, x_n, h_b)$ where the underlying graph $G(\Gamma_b)$ of Γ_b is the one obtained in the previous construction. Choose b such that each point $v \in |\Gamma_b|$ which is an isolated point of $h_b^{-1}(\tau)$ for some $\tau \in \Sigma$, is an I -vertex of $G(\Gamma_b)$. This choice will be important when we want to extend the map π later on. We will point out where exactly, when the time has come. Now we consider the pull back of our original family along φ_b and for simplicity of notation we will still call sections and the coefficients of the polynomials defining the map x_j and β_ρ .

We will proceed in five steps. First we will extend the space of the family, then we will extend the sections, and the morphism to $X(\Sigma)$. Afterwards we will see what the restriction of the extended morphism to the special fibre looks like and finally we will stabilise the family. This is the usual stable reduction business as it can be found for example in Proposition 6 of [FP97]. However, we want to know exactly what the limit stable map looks like (cf. (47)), as we will need this several times. This makes it necessary to work with coordinates, which unfortunately becomes quite messy.

1. EXTENDING THE UNDERLYING CURVE: First we want to describe an algorithm that computes an extension \mathcal{C} of the underlying curve of the family by blowing up the trivial extension $\mathbb{P}_{D_{\mathfrak{R}}}^1$ several times. We will do this in a way such that we can extend the morphism π and the sections x_j to \mathcal{C} in the following steps. For this it will be necessary to have several sets of coordinates on affine open subsets of \mathcal{C} . These different coordinates and transformations between them, are given in formulas (40), (41) and (42).

Let $C^{(0,k)}$ denote the fibre of the projection $\text{pr} : \text{Proj } \mathfrak{R}[[t]] [z_0, z_1] = \mathbb{P}_{D_{\mathfrak{R}}}^1 \rightarrow D_{\mathfrak{R}}^*$ over \mathfrak{m} . Let $\mathcal{U}_0 := \text{Spec } \mathfrak{R}[[t]] [z^{(0,k)}]$ and $\mathcal{U}_1 := \text{Spec } \mathfrak{R}[[t]] [\tilde{z}^{(0,k)}]$ denote the charts of $\mathbb{P}_{D_{\mathfrak{R}}}^1$, where $z^{(0,k)} := \frac{z_0}{z_1}$ and $\tilde{z}^{(0,k)} := \frac{\tilde{z}_0}{\tilde{z}_1}$. For a power series $p = \sum_i p_i t^i \in \mathfrak{R}[[t]]$ we want to write $[p]^{(m)} := \sum_{i \geq m} p_i t^{i-m}$ and $[p]^{(m)} := \sum_{i < m} p_i t^i$. Let $x_j = \sum_m \gamma_m^j t^m$, let b_ρ denote the lowest non-zero coefficient of β_ρ and let N denote a number such that $V(m, k)$ is not a vertex of $G(\Gamma_b)$ for all $k \in [n]$ and $m \geq N$. In the following algorithm the lines 2, 3 and 11 to 21 have the purpose to construct an open affine cover of the total space \mathcal{C} of the family

over $D_{\mathfrak{R}}$. We will explain the meaning of the coordinates after the algorithm. Let $I(m, k)$ be as in (36).

```

1:  $\mathcal{C} := \mathbb{P}_{D_{\mathfrak{R}}}^1$ 
2:  $R^{(0,k)} := \mathfrak{R}[[t]] [z^{(0,k)}]$  and  $\mathcal{U}_0^{(0,k)} := \text{Spec } R^{(0,k)}$ 
3:  $\tilde{R}^{(0,k)} := \mathfrak{R}[[t]] [\tilde{z}^{(0,k)}]_{\prod_{j \in I(0,k)} (x_j \tilde{z}^{(0,k)} - 1)}$  and  $\mathcal{U}_1^{(0,k)} := \text{Spec } \tilde{R}^{(0,k)}$ 
4: for  $m = 1$  to  $N$  do
5:    $I = \emptyset$ 
6:   for  $k = 1$  to  $n$  do
7:     if  $k \notin I$  then
8:       if  $V(m, k)$  is a vertex of  $G(\Gamma_b)$  then
9:          $P := (1 : \gamma_{m-1}^k) \in C^{(m-1,k)} \subset \mathcal{C}$ 
10:         $\mathcal{C} := \text{Bl}_P \mathcal{C}^1$ , with exceptional divisor  $C^{(m,k)} := \text{Proj } \mathfrak{R} [z_0^{(m,k)}, z_1^{(m,k)}]$ 
11:         $z^{(m,k)} := \frac{z_1^{(m,k)}}{z_0^{(m,k)}}$  and  $\tilde{z}^{(m,k)} := \frac{z_0^{(m,k)}}{z_1^{(m,k)}}$ 
12:         $R^{(m,k)} := R^{(m-1,k)} [z^{(m,k)}] / \langle z^{(m-1,k)} - \gamma_{m-1}^k - z^{(m,k)}t \rangle$ 
13:         $\mathcal{U}_0^{(m,k)} := \text{Spec } R^{(m,k)}$ 
14:         $\tilde{R}^{(m,k)} := R^{(m-1,k)} [\tilde{z}^{(m,k)}] / \langle \tilde{z}^{(m,k)}(z^{(m-1,k)} - \gamma_{m-1}^k) - t \rangle$ 
15:         $\mathcal{U}_1^{(m,k)} := \text{Spec } \tilde{R}^{(m,k)}$ 
16:         $f^{(m-1,k)} := \prod_{j \in I(m,k)} (z^{(m-1,k)} - [x_j]^{(m-1)})$ 
17:         $R^{(m-1,k)} := R_{f^{(m-1,k)}}^{(m-1,k)}$  and  $\mathcal{U}_0^{(m-1,k)} := \text{Spec } R^{(m-1,k)}$ 
18:        for  $j \in I(m, k)$  do
19:          if  $V(m+1, j)$  is a vertex of  $G(\Gamma_b)$  then
20:             $\tilde{R}^{(m,k)} := \tilde{R}_{[x_j]^{(m)} \tilde{z}^{(m,k)} - 1}^{(m,k)}$  and  $\mathcal{U}_1^{(m,k)} := \text{Spec } \tilde{R}^{(m,k)}$ 
21:          end if
22:        end for
23:      end if
24:       $I := I \cup I(m, k)$ 
25:    end if
26:  end for
27: end for

```

We obtain a flat and proper morphism $p : \mathcal{C} \rightarrow D_{\mathfrak{R}}$ whose special fibre C (the fibre over \mathfrak{m}) has irreducible components in bijection with the vertices of $G(\Gamma_b)$ via $C^{(m,k)} \mapsto V(m, k)$. Furthermore it is easy to see from the procedure above that $V(m_1, k_1)$ and $V(m_2, k_2)$ are adjacent via an edge in $G(\Gamma_b)$ if and only if $C^{(m_1, k_1)}$ and $C^{(m_2, k_2)}$ intersect in a node, i.e. $G(\Gamma_b)$ is isomorphic to the dual graph of C . It can be checked that $\mathcal{U}_0^{(m,k)}$ and $\mathcal{U}_1^{(m,k)}$ for $m = 0, \dots, N$ cover all of \mathcal{C} .

Let us now explain the meaning of the coordinates. A neighbourhood of P in line 9 is isomorphic to a neighbourhood of $\langle t, z \rangle \in \text{Spec } \mathfrak{R}[[t]] [z]$. In order to compute the blow up in P we need to introduce two new coordinates $z_0^{(m,k)}, z_1^{(m,k)}$ in line 10 which are then the coordinates of the exceptional divisor $C^{(m,k)}$, cf. Remark 2.2.15. According to that remark these coordinates satisfy the relation

$$z_0^{(m,k)}(z^{(m-1,k)} - \gamma_{m-1}^k) = z_1^{(m,k)}t.$$

In lines 12 to 15 we define $\mathcal{U}_0^{(m,k)}$ as the chart of $\text{Bl}_P \mathcal{U}_0^{(m-1,k)}$ where $z_0^{(m,k)} \neq 0$ and $\mathcal{U}_1^{(m,k)}$ as the chart where $z_1^{(m,k)} \neq 0$. Note that $\mathcal{U}_0^{(m,k)} \setminus Z(t)$ is isomorphic to an open subscheme of $\mathcal{U}_0 \setminus Z(t)$. We will describe this isomorphism explicitly later on in formulas (40) and (41). In lines 16 and 17 we remove $Z(f^{(m-1,k)})$ from $\mathcal{U}_0^{(m-1,k)}$, which ensures that this chart

¹ $\text{Bl}_P \mathcal{C}$ denotes the blow up of \mathcal{C} in the point P

will contain no nodes of the special fibre C . The chart $\mathcal{U}_1^{(m,k)}$ contains exactly the node $C^{(m,k)} \cap C^{(m-1,k)}$, after we deleted $Z(\lfloor x_j \rfloor^{(m)} \tilde{z}^{(m,k)} - 1)$ for several j in lines 18 to 22. In the following, formulas (40) to (42), we want to describe several isomorphisms from the rings $R^{(m,k)}$ and $\tilde{R}^{(m,k)}$ to other rings, but we will omit the localisations from line 17 and 20 as the notation is already messy enough without them. It is clear how to extend such isomorphisms, namely if $\phi : R \xrightarrow{\sim} S$ is an isomorphism, so is $\phi : R_f \rightarrow S_{\phi(f)}$. For schemes this corresponds to restricting an isomorphism to open subschemes.

Let us now come back to the isomorphism of $\mathcal{U}_0^{(m,k)} \setminus Z(t)$ to an open subscheme of $\mathcal{U}_0 \setminus Z(t)$, which we will describe in terms of \mathfrak{K} -algebras, where the isomorphism is given by

$$(40) \quad \begin{aligned} & \mathfrak{K}[[t]]_t [z^{(l,k)} \mid 0 \leq l \leq m] / \langle z^{(l-1,k)} - \gamma_{l-1}^k - z^{(l,k)}t \mid 0 \leq l \leq m \rangle \xrightarrow{\sim} \mathfrak{K}[[t]]_t [z^{(0,k)}] \\ & z^{(l,k)} \mapsto t^{-l}(z^{(0,k)} - \lceil x_k \rceil^{(l)}) \text{ for } 0 \leq l \leq m \text{ and } \mathfrak{K}[[t]]_t \xrightarrow{\text{id}} \mathfrak{K}[[t]]_t. \end{aligned}$$

One can see that this is an isomorphism by successively replacing $z^{(l,k)}$ by $z^{(l-1,k)}$ using the relations that we mod out. The scheme $\mathcal{U}_0^{(m,k)} \setminus Z(t)$ is by construction the spectrum of the localisation of the ring on the left by a ring element f and the open subscheme of $\mathcal{U}_0 \setminus Z(t)$ is then the spectrum of the ring on the right localised at the image of f .

From now on we want to use different coordinates on $\mathcal{U}_0^{(m,k)}$, which are given by the isomorphism

$$(41) \quad \begin{aligned} & \mathfrak{K}[[t]] [z^{(m,k)}] \xrightarrow{\sim} \mathfrak{K}[[t]] [z^{(l,k)} \mid 0 \leq l \leq m] / \langle z^{(l-1,k)} - \gamma_{l-1}^k - z^{(l,k)}t \mid 0 \leq l \leq m \rangle \\ & z^{(m,k)} \mapsto z^{(m,k)} \text{ and } \mathfrak{K}[[t]] \xrightarrow{\text{id}} \mathfrak{K}[[t]]. \end{aligned}$$

That this is in fact an isomorphism is also easy to see using the relations we mod out. We want to denote the composition of the isomorphisms in (40) and (41) by $\phi_{(m,k)}$.

For $m \geq 1$, we also want to use different coordinates on $\mathcal{U}_1^{(m,k)}$ from now on. Using (41) we can identify the rings $\mathfrak{K}[[t]] [z^{(l,k)} \mid 0 \leq l \leq m-1] / \langle z^{(l-1,k)} - \gamma_{l-1}^k - z^{(l,k)}t \mid 0 \leq l \leq m-1 \rangle$ and $\mathfrak{K}[[t]] [z^{(m-1,k)}]$, therefore $\mathcal{U}_1^{(m,k)}$ is the spectrum of

$$S^{(m,k)} := \mathfrak{K}[[t]] [z^{(m-1,k)}] [\tilde{z}^{(m,k)}] / \langle \tilde{z}^{(m,k)}(z^{(m-1,k)} - \gamma_{m-1}^k) - t \rangle$$

localised at some ring element. There is an isomorphism of $\mathcal{U}_1^{(m,k)} \setminus Z(t)$ with an open subscheme of $\mathcal{U}_0 \setminus Z(t)$

$$(42) \quad \begin{aligned} & \tilde{\phi}_{(m,k)} : S_t^{(m,k)} \xrightarrow{\sim} \mathfrak{K}[[t]]_t [z^{(0,k)}]_{z^{(0,k)} - \lceil x_k \rceil^{(m)}} \\ & z^{(m-1,k)} \mapsto (z^{(0,k)} - \lceil x_k \rceil^{(m-1)})t^{-(m-1)} \\ & \tilde{z}^{(m,k)} \mapsto (z^{(0,k)} - \lceil x_k \rceil^{(m)})^{-1}t^m \text{ and } \mathfrak{K}[[t]] \xrightarrow{\text{id}} \mathfrak{K}[[t]]. \end{aligned}$$

2. EXTENDING THE SECTIONS x_j : The section $x_j : D_{\mathfrak{K}}^* \rightarrow \mathcal{C}^* := \mathcal{C} \setminus C$ can be extended uniquely to a section $x_j : D_{\mathfrak{K}} \rightarrow \mathcal{C}$ by the valuative criterion of properness. We claim that $x_j(\mathfrak{m}) = (1 : \gamma_{m_j}^j) \in C^{(m_j,j)}$, where $m_j := \max\{m \mid V(m,j) \text{ is a vertex of } G(\Gamma_b)\}$. In particular the images $x_j(\mathfrak{m})$ are distinct smooth points of C . To see this we consider the restricted section $x_j : D_{\mathfrak{K}}^* \rightarrow \mathcal{U}_0 \setminus Z(t)$. This restriction is given by a \mathfrak{K} -algebra homomorphism $\chi_j : \mathfrak{K}[[t]]_t [z^{(0,k)}] \rightarrow \mathfrak{K}[[t]]_t$ with $\chi_j(t) = t$ and $\chi_j(z^{(0,k)}) = x_j$. Now we use the isomorphisms from (40) and (41) and obtain that $\chi_j \circ \phi_{(m_j,j)}(t) = t$ and $\chi_j \circ \phi_{(m_j,j)}(z^{(m_j,j)}) = \lfloor x_j \rfloor^{(m_j)}$, which means that $x_j(\mathfrak{m}) = (1 : \gamma_{m_j}^j) \in C^{(m_j,j)} \subset \mathcal{U}_0^{(m_j,j)}$.

3. EXTENDING π : We want to extend π from $\mathcal{U}_i^{(m,k)} \setminus Z(t)$ to $\mathcal{U}_i^{(m,k)}$ for $i = 0, 1$, separately on each chart and then check that these extensions coincide on intersections, hence they define a global extension $\pi : \mathcal{C} \rightarrow X(\Sigma)$.

First we extend $\pi : \mathcal{U}_0^{(m,k)} \setminus Z(t) \rightarrow X(\Sigma)$ to $\mathcal{U}_0^{(m,k)}$ for $m = 0, \dots, N$. On $\mathcal{U}_0 \setminus Z(t)$ the global section π_ρ of $\mathcal{O}(d_\rho)$ trivialises to the regular function $\pi_\rho = \beta_\rho \prod_j (x_j - z^{(0,k)})^{\alpha_\rho^j}$ which has the preimage

$$\phi_{(m,k)}^{-1} \pi_\rho = \beta_\rho \prod_j (x_j - \lceil x_k \rceil^{(m)} - z^{(m,k)} t^m)^{\alpha_\rho^j}$$

on $\mathcal{U}_0^{(m,k)} \setminus Z(t)$. Clearly this extends to a regular function on $\mathcal{U}_0^{(m,k)}$. For $0 \leq l \leq m-1$ and $j \in I(l,k) \setminus I(l+1,k)$ we have $v(x_j - \lceil x_k \rceil^{(m)}) = l$ while $v(x_j - \lceil x_k \rceil^{(m)}) = m$ for $j \in I(m,k)$. Clearly $v(x_j - \lceil x_k \rceil^{(m)})$ is the maximal power of t which divides the term $x_j - \lceil x_k \rceil^{(m)} - z^{(m,k)} t^m$ in $\mathfrak{K}[[t]] [z^{(m,k)}]$. Adding this up we see that

$$v_\rho^{(m,k)} := v(\beta_\rho) + \sum_{l=1}^m \sum_{j \in I(l,k)} \alpha_\rho^j$$

is the maximal power of t that divides $\phi_{(m,k)}^{-1} \pi_\rho$ in $\mathfrak{K}[[t]] [z^{(m,k)}]$. The point $(v_\rho^{(m,k)})_\rho$ equals $\tilde{h}_b(V(m,k))$ from Construction 2.2.20. By Lemma 2.1.13 there are a unique cone $\sigma_{V(m,k)} \in \Sigma$ and a point $(v_\rho^{(m,k)})_\rho \in \mathbb{Z}_{\geq 0}^{\Sigma(1)}$ such that $h_b(V(m,k)) \in \sigma_{V(m,k)}^\circ$ and $v_\rho^{(m,k)} > 0$ iff $\rho \in \sigma_{V(m,k)}(1)$. By Remark 2.1.7 the regular functions $\pi_\rho^{(m,k)} := t^{v_\rho^{(m,k)} - v_\rho^{(m,k)}} \phi_{(m,k)}^{-1} \pi_\rho$ define the same morphism as $(\phi_{(m,k)}^{-1} \pi_\rho)_\rho$ on $\mathcal{U}_0^{(m,k)} \setminus Z(t)$. When we say that regular functions define a morphism, we actually mean the Σ -collection where all bundles and trivialisations are trivial. Therefore we omit these redundant data. A computation shows that

$$\pi_\rho^{(m,k)} = t^{v_\rho^{(m,k)}} \lfloor \beta_\rho \rfloor^{(v(\beta_\rho))} \prod_{l=0}^m \prod_{j \in J(l,k)} \left(\lfloor x_j - \lceil x_k \rceil^{(m)} \rfloor^{(l)} - t^{m-l} z^{(m,k)} \right)^{\alpha_\rho^j},$$

where $J(l,k) = I(l,k) \setminus I(l+1,k)$ for $0 \leq l \leq m-1$ and $J(m,k) = I(m,k)$. Hence $\pi_\rho^{(m,k)}|_{Z(t)} = 0$ if $\rho \in \sigma_{V(m,k)}(1)$ and

$$(43) \quad \pi_\rho^{(m,k)}|_{Z(t)} = c_\rho \prod_{j \in I(m,k)} (\gamma_m^j - z^{(m,k)})^{\alpha_\rho^j}$$

for some $c_\rho \in \mathfrak{K}^*$, else. So condition (2) of Definition 2.1.2 could by Remark 2.1.3 only be violated in the points $\langle t, z^{(m,k)} - \gamma_m^j \rangle$, but those do by construction not belong to $\mathcal{U}_0^{(m,k)}$. Hence $(\pi_\rho^{(m,k)})_\rho$ defines a morphism $\pi^{(m,k)} : \mathcal{U}_0^{(m,k)} \rightarrow X(\Sigma)$, which extends our original morphism $\pi : \mathcal{U}_0^{(m,k)} \setminus Z(t) \rightarrow X(\Sigma)$.

Now we want to extend $\pi : \mathcal{U}_1^{(m,k)} \setminus Z(t) \rightarrow X(\Sigma)$ to $\mathcal{U}_1^{(m,k)}$ for $m = 1, \dots, N$. As above the global section π_ρ of $\mathcal{O}(d_\rho)$ trivialises to the regular function $\pi_\rho = \beta_\rho \prod_j (x_j - z^{(0,k)})^{\alpha_\rho^j}$ on $\mathcal{U}_0 \setminus Z(t)$. We obtain

$$\tilde{\phi}_{(m,k)}^{-1} \pi_\rho = \beta_\rho \prod_j (x_j - \lceil x_k \rceil^{(m-1)} - z^{(m-1,k)} t^{m-1})^{\alpha_\rho^j}$$

which obviously which extends to a regular function on $\mathcal{U}_1^{(m,k)}$. We can apply the same arguments as above with $m-1$ to obtain that

$$\begin{aligned} & t^{v_\rho^{(m-1,k)} - v_\rho^{(m-1,k)}} \tilde{\phi}_{(m,k)}^{-1} \pi_\rho = \\ & t^{v_\rho^{(m-1,k)}} \lfloor \beta_\rho \rfloor^{(v(\beta_\rho))} \prod_{j \in I(m,k)} \left(\lfloor x_j - \lceil x_k \rceil^{(m)} \rfloor^{(m-1)} - (z^{(m-1,k)} - \gamma_{m-1}^k) \right)^{\alpha_\rho^j} \\ & \cdot \prod_{l=0}^{m-1} \prod_{j \in I(l,k) \setminus I(l+1,k)} \left(\lfloor x_j - \lceil x_k \rceil^{(m)} \rfloor^{(l)} - t^{m-1-l} (z^{(m-1,k)} - \gamma_{m-1}^k) \right)^{\alpha_\rho^j}. \end{aligned}$$

For $j \in I(m, k)$ the formal power series $\lfloor x_j - \lceil x_k \rceil^{(m)} \rfloor^{(m-1)}$ equals $t \lfloor x_j \rfloor^{(m)}$ and hence $\lfloor x_j - \lceil x_k \rceil^{(m)} \rfloor^{(m-1)} - (z^{(m-1, k)} - \gamma_{m-1}^k)$ is divisible by $z^{(m-1, k)} - \gamma_{m-1}^k$ in $S^{(m, k)}$. We obtain

$$\begin{aligned} \tilde{\pi}_\rho^{(m, k)} &:= (z^{(m-1, k)} - \gamma_{m-1}^k)^{v_\rho^{(m, k)} - v_\rho^{(m-1, k)}} (z^{(m, k)})^{v_\rho^{(m-1, k)} - v_\rho^{(m-1, k)}} \tilde{\phi}_{(m, k)}^{-1} \pi_\rho = \\ &(z^{(m-1, k)} - \gamma_{m-1}^k)^{v_\rho^{(m, k)}} (\tilde{z}^{(m, k)})^{v_\rho^{(m-1, k)}} [\beta_\rho]^{(v(\beta_\rho))} \prod_{j \in I(m, k)} \left((t \lfloor x_j \rfloor^{(m+1)} + \gamma_m^j) \tilde{z}^{(m, k)} - 1 \right)^{\alpha_\rho^j} \\ &\cdot \prod_{l=0}^{m-1} \prod_{j \in I(l, k) \setminus I(l+1, k)} \left((R_j + (\gamma_l^j - \gamma_l^k)) - t^{m-1-l} (z^{(m-1, k)} - \gamma_{m-1}^k) \right)^{\alpha_\rho^j} \end{aligned}$$

for some $R_j \in \langle t \rangle$. Clearly $\tilde{\pi}_\rho^{(m, k)}$ is still a regular function on $\mathcal{U}_1^{(m, k)}$ and by Lemma 2.1.13 and Remark 2.1.7, the morphisms defined by the regular functions $(\tilde{\pi}_\rho^{(m, k)})_\rho$ and $(\tilde{\phi}_{(m, k)}^{-1} \pi_\rho)_\rho$ coincide on $\mathcal{U}_1^{(m, k)} \setminus Z(t)$. As for the case of $\pi_\rho^{(m, k)}$ above, we will now check that condition (2) of Definition 2.1.2 is also satisfied on $Z(\tilde{z}^{(m, k)}) = C^{(m-1, k)} \cap \mathcal{U}_1^{(m, k)}$. We have $\tilde{\pi}_\rho^{(m, k)}|_{Z(\tilde{z}^{(m, k)})} = 0$ if $\rho \in \sigma_{V(m-1, k)}(1)$ and for $\rho \notin \sigma_{V(m-1, k)}(1)$ we have

$$(44) \quad \begin{aligned} \tilde{\pi}_\rho^{(m, k)}|_{Z(\tilde{z}^{(m, k)})} &= c_\rho^{(m-1, k)} \left(\prod_{j \in I(m, k)} (-1)^{\alpha_\rho^j} \right) \\ &\cdot (z^{(m-1, k)} - \gamma_{m-1}^k)^{v_\rho^{(m, k)}} \prod_{j \in I(m-1, k) \setminus I(m, k)} (\gamma_{m-1}^j - z^{(m-1, k)})^{\alpha_\rho^j} \end{aligned}$$

with $c_\rho^{(m-1, k)} = b_\rho \prod_{l=0}^{m-2} \prod_{j \in I(l, k) \setminus I(l+1, k)} (\gamma_l^j - \gamma_l^k)^{\alpha_\rho^j} \in \mathfrak{K}^*$. For $j \in I(m-1, k) \setminus I(m, k)$ the points $(1 : \gamma_{m-1}^j) \in C^{(m-1, k)}$ do not belong to $\mathcal{U}_1^{(m, k)}$, therefore condition (2) might only be violated at $P := (1 : \gamma_{m-1}^k) \in C^{(m-1, k)}$. Note that P is the node of C connecting $C^{(m-1, k)}$ and $C^{(m, k)}$. We see $\tilde{\pi}_\rho^{(m, k)}(P) = 0$ if and only if $\rho \in \sigma_{V(m-1, k)}(1) \cup \sigma_{V(m, k)}(1)$ and this is where our choice of b comes into play. By the choice of b the edge between $V(m-1, k)$ and $V(m, k)$ is mapped entirely into some cell $\tau \in \Sigma$ by h , hence $\tau(1) \supset \sigma_{V(m-1, k)}(1) \cup \sigma_{V(m, k)}(1)$ and condition (2) is satisfied at P . Similarly we can check that condition (2) is also satisfied on $Z(\gamma_{m-1}^k - z^{(m-1, k)})$ and hence on all of $\mathcal{U}_1^{(m, k)}$. Therefore $(\tilde{\pi}_\rho^{(m, k)})_\rho$ defines a morphism $\tilde{\pi}^{(m, k)} : \mathcal{U}_1^{(m, k)} \rightarrow X(\Sigma)$ which extends the original morphism $\pi : \mathcal{U}_1^{(m, k)} \setminus Z(t) \rightarrow X(\Sigma)$. For later use we want to note that if $\rho \in \sigma_{V(m, k)}(1)$ we have $\tilde{\pi}_\rho^{(m, k)}|_{Z(\gamma_{m-1}^k - z^{(m-1, k)})} = 0$ and

$$(45) \quad \tilde{\pi}_\rho^{(m, k)}|_{Z(\gamma_{m-1}^k - z^{(m-1, k)})} = c_\rho^{(m, k)} (\tilde{z}^{(m, k)})^{v_\rho^{(m-1, k)}} \prod_{j \in I(m, k)} (\gamma_m^j \tilde{z}^{(m, k)} - 1)^{\alpha_\rho^j}$$

for $\rho \notin \sigma_{V(m, k)}(1)$, where $c_\rho^{(m, k)}$ is defined as above.

Finally we extend $\pi : \mathcal{U}_1^{(0, k)} \setminus Z(t) \rightarrow X(\Sigma)$ to $\mathcal{U}_1^{(0, k)}$. On $\mathcal{U}_1 \setminus Z(t)$ the global section π_ρ from (39) trivialises to $\tilde{\pi}_\rho = \beta_\rho \prod_j (x_j \tilde{z}^{(0, k)} - 1)^{\alpha_\rho^j}$. This clearly extends to a regular function on $\mathcal{U}_1^{(0, k)}$ which is $v(\beta_\rho)$ -times divisible by t . As above we obtain regular functions $\tilde{\pi}_\rho^{(0, k)} := t^{v_\rho^{(0, k)} - v_\rho^{(0, k)}} \tilde{\pi}_\rho = t^{v_\rho^{(0, k)}} [\beta_\rho]^{(v(\beta_\rho))} \prod_{j \in I(0, k)} (x_j \tilde{z}^{(0, k)} - 1)^{\alpha_\rho^j}$ on $\mathcal{U}_1^{(0, k)}$. As before, they define the same morphism as $(\tilde{\pi}_\rho)_\rho$ when restricted to $\mathcal{U}_1^{(0, k)} \setminus Z(t)$. We have $\tilde{\pi}_\rho^{(0, k)}|_{Z(t)} = 0$ for $\rho \in \sigma_{V(0, k)}(1)$ and

$$(46) \quad \tilde{\pi}_\rho^{(0, k)}|_{Z(t)} = b_\rho \prod_j \left(\gamma_0^j \tilde{z}^{(0, k)} - 1 \right)^{\alpha_\rho^j}$$

for $\rho \notin \sigma_{V(0,k)}(1)$. Since none of the points $(1 : \gamma_0^j) \in C^{(0,k)}$ belongs to $\mathcal{U}_1^{(0,k)}$, condition (2) of Definition 2.1.2 is satisfied on $\mathcal{U}^{(0,k)}$. Therefore the tuple $(\tilde{\pi}_\rho^{(0,k)})_\rho$ defines a morphism $\tilde{\pi}^{(0,k)} : \mathcal{U}_1^{(0,k)} \rightarrow X(\Sigma)$ which extends $\pi : \mathcal{U}_1^{(0,k)} \setminus Z(t) \rightarrow X(\Sigma)$.

Now we want to see that all these morphisms patch to a morphism $\pi : \mathcal{C} \rightarrow X(\Sigma)$. Let U denote the intersection of all charts, which is clearly contained in \mathcal{C}^* . Then $U \subset \mathcal{U}_0^{(m_1,k_1)} \cap \mathcal{U}_0^{(m_2,k_2)}$ is an open dense subset on which by construction $\pi^{(m_1,k_1)} = \pi^{(m_2,k_2)}$. Therefore, as $X(\Sigma)$ is separated and \mathcal{C} is integral, we have $\pi^{(m_1,k_1)} = \pi^{(m_2,k_2)}$ on the whole intersection $\mathcal{U}_0^{(m_1,k_1)} \cap \mathcal{U}_0^{(m_2,k_2)}$. The same argument for the other possible intersections of the charts shows that we indeed obtain a global morphism $\pi : \mathcal{C} \rightarrow X(\Sigma)$.

4. π ON THE SPECIAL FIBRE C : Now we want to explicitly describe the restricted morphism $\pi : C \rightarrow X(\Sigma)$. Let $\pi|_{C^{(m,k)}}$ be given by polynomials $\pi_\rho^{C^{(m,k)}}$, which we will determine in the following. For this we will need the charts $\mathcal{U}_1^{(m+1,i)}$ for $i \in I(m,k)$, where $C^{(m,k)}$ is given by $Z(\tilde{z}^{(m+1,i)})$, and additionally $\mathcal{U}_1^{(m,k)}$, where $C^{(m,k)}$ is given by $Z(\gamma_m^k - z^{(m,k)})$. We need all of these charts in order to cover all the special points on the irreducible component. Let $I(m,k) = \prod_{i=1}^r I(m+1,k_i)$ with $k_1 = k$, and let $E^{(i)} = \sum_{j \in I(m+1,k_i)} X_j$. Here $X_j = \sum_\rho \alpha_\rho^j e_\rho$ as in Construction 2.2.20. Then there is a unique cone $\tau_i \in \Sigma$ with $\tau_i \geq \sigma_{V(m,k)}$ such that the image of $p_\Sigma(E^{(i)})$ in $\mathbb{R}^m / V_{\sigma_{V(m,k)}}$ lies in $\bar{\tau}_i^\circ$. This means there are unique integers $e_\rho^{(i)}$ with $p_\Sigma(E^{(i)}) = \sum_\rho e_\rho^{(i)} u_\rho$, such that $e_\rho^{(i)} > 0$ if $\rho \in \tau_i(1) \setminus \sigma_{V(m,k)}(1)$, $e_\rho^{(i)} \in \mathbb{Z}$ if $\rho \in \sigma_{V(m,k)}(1)$ and $e_\rho^{(i)} = 0$ else.

In particular $E^{(i)} \equiv (e_\rho^{(i)})_\rho \pmod{L_\Sigma}$ and we can apply Remark 2.1.7 to (44) and we see that the regular functions

$$c_\rho^{(m,k)} \left(\prod_{j \in I(m+1,k)} (-1)^{\alpha_\rho^j} \right) (z^{(m,k)} - \gamma_m^k) v_\rho^{(m+1,k)} \prod_{i=2}^r (\gamma_m^{k_i} - z^{(m,k)})^{e_\rho^{(i)}}$$

define the same morphism on $\mathcal{U}_1^{(m+1,k)} \cap C^{(m,k)}$ as those in (44). After applying Remark 2.1.7 one more time for $E^{(1)}$ and the factor -1 , we end up with

$$s_\rho^{(0)} := c_\rho^{(m,k)} (-1)^{e_\rho^{(1)}} (z^{(m,k)} - \gamma_m^k) v_\rho^{(m+1,k)} \prod_{i=2}^r (\gamma_m^{k_i} - z^{(m,k)})^{e_\rho^{(i)}},$$

still defining the same morphism. Note that $\tilde{h}_b(V(m,k)) + E^{(1)} = \tilde{h}_b(V(m+1,k))$ so we have $E^{(1)} \equiv (v_\rho^{(m+1,k)} - v_\rho^{(m,k)})_\rho \pmod{L_\Sigma}$. By our choice of b the two cones $\sigma_{V(m,k)}$ and $\sigma_{V(m+1,k)}$ are faces of the cone $\tau_1 \in \Sigma$ from above. By definition $v_\rho^{(m,k)} = 0$ for $\rho \notin \sigma_{V(m,k)}(1)$ and $v_\rho^{(m+1,k)} - v_\rho^{(m,k)} = 0$ for $\rho \notin \tau_1(1)$, so we must have $(v_\rho^{(m+1,k)} - v_\rho^{(m,k)})_\rho = (e_\rho^{(1)})_\rho$. Therefore

$$s_\rho^{(0)} = c_\rho^{(m,k)} \prod_{i=1}^r (\gamma_m^{k_i} - z^{(m,k)})^{e_\rho^{(i)}}$$

on $\mathcal{U}_1^{(m+1,k)}$. On the other charts $\mathcal{U}_1^{(m+1,i)} \cap C^{(m,k)}$ we obtain the same sections. Alternatively, we can say that $s_\rho^{(0)}$ extends to all of these charts. On the chart $\mathcal{U}_1^{(m,k)}$ we can do the same and we obtain that the regular functions

$$s_\rho^{(1)} := c_\rho^{(m,k)} (\tilde{z}^{(m,k)}) v_\rho^{(m-1,k)} \prod_{i=1}^r (\gamma_m^{k_i} \tilde{z}^{(m,k)} - 1)^{e_\rho^{(i)}}$$

which define the same morphism as those from (45), respectively (46). Furthermore the cones $\sigma_{V(m,k)}$ and $\sigma_{V(m-1,k)}$ span a cone $\tau_0 \in \Sigma$. As above we see that for $e_\rho^{(0)} := v_\rho^{(m-1,k)} - v_\rho^{(m,k)}$ we have $e_\rho^{(0)} > 0$ if $\rho \in \tau_0(1) \setminus \sigma_{V(m,k)}(1)$, $e_\rho^{(0)} \in \mathbb{Z}$ for $\rho \in \sigma_{V(m,k)}(1)$ and $e_\rho^{(0)} = 0$

else. If we define $d_\rho^{(m,k)} = \sum_{i=0}^r e_\rho^{(i)}$ it is now clear that $s_\rho^{(0)}$ and $s_\rho^{(1)}$ glue to a global section $\pi_\rho^{C^{(m,k)}}$ of $\mathcal{O}(d_\rho^{(m,k)})$ which looks as follows:

$$(47) \quad \pi_\rho^{C^{(m,k)}} = \begin{cases} c_\rho^{(m,k)} (z_0^{(m,k)})^{e_\rho^{(0)}} \prod_{i=1}^r \left(z_0^{(m,k)} \gamma_m^{k_i} - z_1^{(m,k)} \right)^{e_\rho^{(i)}} & \text{if } \rho \notin \sigma_{V(m,k)}(1) \\ 0 & \text{if } \rho \in \sigma_{V(m,k)}(1) \end{cases}$$

$$\text{with } c_\rho^{(m,k)} = b_\rho \prod_{l=0}^{m-1} \prod_{j \in I(l,k) \setminus I(l+1,k)} (\gamma_l^j - \gamma_l^k)^{\alpha_\rho^j}.$$

Note that for $m = 0$ there is no $E^{(0)}$, therefore we read the above formula with $(e_\rho^{(0)})_\rho = 0$ in that case. Also $\left(\sum_{i=0,1,\dots,r} e_\rho^{(i)} \bar{u}_\rho \right)$ is the local degree of $(\Gamma_b, x_1, \dots, x_n, h_b)$ around $V(m, k)$ in $\text{Star}_\Sigma(\sigma_{V(m,k)})$, as it is claimed in Theorem 2.2.18. Again, for $m = 0$ we must leave out $i = 0$.

5. STABILISING THE FAMILY: The special fibre C might be unstable, so we have to get rid of the unstable components. It is possible to just contract the unstable components of the limit. Proposition 3.10 of [BM96] tells us that there is a family of stable maps $(\tilde{C}, \tilde{p}, D_{\tilde{R}}, \tilde{x}_1, \dots, \tilde{x}_n, \tilde{\pi})$, and a proper surjective morphism $f : C \rightarrow \tilde{C}$ over $D_{\tilde{R}}$ such that $\pi = \tilde{\pi} \circ f$, $p = \tilde{p} \circ f$ and $\tilde{x}_j = f \circ x_j$ for $j \in [n]$. Furthermore f is one-to-one on geometric points which do not lie on unstable components of C . So $(\tilde{C}, \tilde{p}, D_{\tilde{R}}, \tilde{x}_1, \dots, \tilde{x}_n, \tilde{\pi})$ is a family of stable maps which extends the family we started with.

Note that unstable components will be those on which the map is constant and on which there are less than three special points. As we saw above, $C^{(m,k)}$ is unstable if and only if $V(m, k)$ is an S -vertex of $G(\Gamma_b)$.

Example 2.2.22. Let $\Delta = (2e_1 + 3e_2, e_0 + e_1, e_0 + 2e_3, e_3, e_0)$ be a degree of tropical curves in \mathbb{R}^3 . Let furthermore $\Sigma = L_3^3$ and let $H = Z(\sum_{i=0}^3 y_i) \subset X(\Sigma) = \mathbb{P}^3 = \text{Proj } \mathbb{C}[y_0, y_1, y_2, y_3]$. Let

$$x_1 = 0, \quad x_2 = 1, \quad x_3 = t^2, \quad x_4 = -1, \quad x_5 = \frac{t^2}{1 - 2t^2}$$

$$\text{and } \beta_0 = 1, \quad \beta_1 = \frac{2t^2(t^2 - 1)}{1 - 2t^2}, \quad \beta_2 = -\frac{2(t^2 - 1)^2}{1 - 2t^2}, \quad \beta_3 = \frac{1}{1 - 2t^2}$$

which define a family in $W_{\Delta, H}$ as in the previous construction. Using the geometric series we can see that $x_5 = t^2 + 2t^4 + 4t^6 + \dots$ and hence $I(1, 1) = I(2, 1) = \{1, 3, 5\}$ and $I(3, 5) = I(4, 5) = \{3, 5\}$. All other sets $I(m, k)$ for $m \geq 1$ are $I(m, k) = \{k\}$ for $k \in [5]$. We can compute $(\Gamma, x_1, \dots, x_5, h) = \text{trop}(\mathbb{P}_{D_C^*}^1, \text{pr}, D_C^*, x_1, \dots, x_5, \pi)$, which is depicted below.

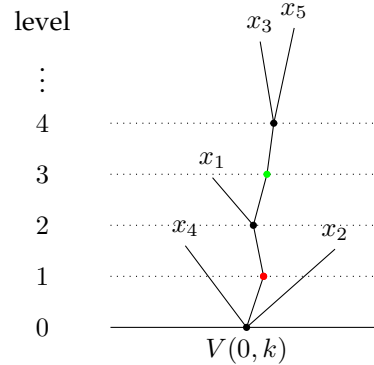
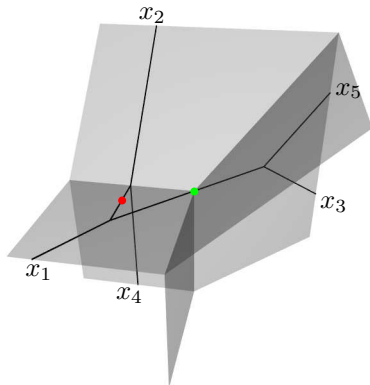

Here the abstract tropical curve Γ is shown on the right together with all its vertices $V(m, k)$ and indicated level structure. There is one I -vertex which is coloured green and one S -vertex which is coloured in red. On the left hand side we see the image $h(|\Gamma|)$ in the tropicalisation L_2^3 of H . By (47) we obtain the following stable limit of the above family:

- On $C^{(0,k)} : (z_0 : z_1) \xrightarrow{\pi} (z_0 - z_1 : 0 : 2z_1 : -z_0 - z_1)$ with markings $x_2(\mathbf{m}) = (1 : 1)$,
 $x_4(\mathbf{m}) = (1 : -1)$ and a node $(1 : 0)$
- On $C^{(2,k)} : (z_0 : z_1) \xrightarrow{\pi} (1 : 0 : 0 : -1)$ with a marking $x_1(\mathbf{m}) = (1 : 0)$
and nodes $(0 : 1)$, $(1 : 1)$
- On $C^{(3,k)} : (z_0 : z_1) \xrightarrow{\pi} (z_1^2 : z_0^2 : -z_0^2 : -z_1^2)$ with nodes $(0 : 1)$, $(1 : 0)$
- On $C^{(4,k)} : (z_0 : z_1) \xrightarrow{\pi} (0 : 1 : -1 : 0)$ with markings $x_3(\mathbf{m}) = (1 : 0)$, $x_5(\mathbf{m}) = (1 : 2)$
and a node $(0 : 1)$.

The component $C^{(1,3)}$ belonging to the red vertex is contracted by the stabilisation. Note that the above family can be obtained from a family over $\text{Spec } \mathbb{C}[[s]]_s$ by a base change $s = t^2$. If we tropicalise the family in s , we obtain the above tropical curve stretched by $\frac{1}{2}$ and the red and the green vertex do not occur. Hence we have an edge of the tropical curve which passes through a cell of lower dimension without seeing it. As in the previous construction, this would cause a problem if we tried to extend the family in s . Therefore we have to apply the base change first.

Lemma 2.2.23. *Let X be a smooth projective variety and let $\beta \in H_2(X)^+$. If $U \subset \overline{M}_{0,n}(X, \beta)$ is a locally closed or open substack, then every stable map $\mathcal{C} = (C, x_1, \dots, x_n, \pi)$ in the closure \overline{U} can be found as the special fibre of a family $(\tilde{C}, p, D_{\mathcal{C}}, \tilde{x}_1, \dots, \tilde{x}_n, \tilde{\pi})$ with generic fibre in U .*

PROOF. Assume we have a family $\mathcal{F} = (C', p', B', x'_1, \dots, x'_n, \pi')$ with $\dim B' > 0$ and a \mathbb{C} -rational point $P \in B'$ such that the fibre over P is \mathcal{C} . For $\phi : B = \text{Spec } \mathcal{O}_{B', P} \rightarrow B'$ the pull back family $\phi^* \mathcal{F}$ clearly has fibre \mathcal{C} over the unique closed point $\mathfrak{n} \in B$. This induces a morphism $B \rightarrow \overline{M}_{0,n}(X, \beta)$ and the closed immersion $\overline{U} \hookrightarrow \overline{M}_{0,n}(X, \beta)$ induces a closed immersion $\overline{T} \hookrightarrow B$ of schemes, where $\overline{T} = \overline{U} \times_B \overline{M}_{0,n}(X, \beta)$, cf. the definition of a substack. In the same way $U \hookrightarrow \overline{U}$ induces a locally closed embedding $T \hookrightarrow \overline{T}$ as a dense subscheme. Now $\mathfrak{n} \in \overline{T}$, by the assumption that \mathcal{C} is in \overline{U} . As B is noetherian we have $\dim B < \infty$. Hence we can find an irreducible curve $\iota : S \hookrightarrow \overline{T}$ passing through \mathfrak{n} and not contained in $T \setminus \overline{T}$, by intersecting with suitable functions $f \in \mathcal{O}_B(B)$ and then choosing an irreducible component. Finally we normalise $\nu : \tilde{S} \rightarrow S$, pick some preimage $P \in \nu^{-1}(\mathfrak{n})$ and the irreducible component S' of \tilde{S} containing P . Let \mathfrak{m}_P be the maximal ideal defining P . By the Cohen Structure Theorem, cf. [Eis04] Theorem 7.7, we obtain an étale neighbourhood of P

$$j : D_{\mathcal{C}} = \text{Spec } \mathbb{C}[[t]] \cong \text{Spec } \hat{\mathcal{O}}_{S', P} \rightarrow \text{Spec } \mathcal{O}_{S', P} \rightarrow S'$$

Then the pull back family $j^* \nu^* \iota^* \phi^* \mathcal{F}$ on $D_{\mathcal{C}}$ has the desired properties. \square

PROOF OF THEOREM 2.2.18. By Lemma 2.2.23 the curve $(C, x_1, \dots, x_n, \pi)$ occurs as geometric fibre over \mathfrak{m} in a family of stable maps over $D_{\mathcal{C}}$. The claim then follows from Constructions 2.2.20 and 2.2.21, in particular part (2) and (3) of the claim can be seen by the formula for the limit map (47). We can apply these constructions by Lemma 2.2.17. \square

Given a family $(C, p, D_{\mathfrak{R}}, x_1, \dots, x_n, \pi)$ with generic fibre in $W_{\Delta, Y'}^\circ$, we defined the tropicalisation of the family restricted to $D_{\mathfrak{R}}^*$ in Construction 2.2.20. Now we want to investigate how to compute the tropicalisation of this family in terms of algebraic intersection theory on $D_{\mathfrak{R}}$. This will be the content of the following two lemmas.

Lemma 2.2.24. *Consider a morphism $D_{\mathfrak{R}} \xrightarrow{\iota} W_{\Delta, Y}$ such that $\iota^{-1}W_{\Delta, Y}^{\circ} \neq \emptyset$. This corresponds to a family in $W_{\Delta, Y}^{\circ}$ over $D_{\mathfrak{R}}^*$, which by Construction 2.2.20 has a tropicalisation \mathcal{C} . If $I = \{i, j, k, l\}$ and $F_I = \text{ft}_I \circ \iota$ then there is the following relation between tropical and algebraic forgetful maps*

$$(48) \quad \text{ft}_I(\mathcal{C}) = \text{ord}_{\mathfrak{m}} F_I^*(ij|kl)v_{ij} + \text{ord}_{\mathfrak{m}} F_I^*(ik|jl)v_{ik} + \text{ord}_{\mathfrak{m}} F_I^*(il|kj)v_{il}.$$

PROOF. We assume that $\text{ft}_I(\mathcal{C}) = \lambda v_{ij} \in \mathcal{M}_{0, I}$, and by Lemma 2.2.17 we can assume that the sections are given by $(1 : x_j) : D_{\mathfrak{R}}^* \rightarrow \mathbb{P}_{D_{\mathfrak{R}}^*}^1$ with $x_j \in \mathfrak{K}[[t]]$. The morphism $F_I : D_{\mathfrak{R}}^* \rightarrow \overline{M}_{0, I} \cong \mathbb{P}^1$ is given by the cross ratio of the four sections in I , and there is an affine chart $\text{Spec } \mathbb{C}[x] \subset \mathbb{P}^1$ such that the divisor $(ij|kl)$ is given by the regular function x . Its pull back therefore is

$$F_I^*(ij|kl) = F_I^*x = \frac{(x_j - x_i)(x_k - x_l)}{(x_j - x_l)(x_k - x_i)} \in \mathfrak{K}[[t]]_t$$

and it vanishes with order $v(F_I^*x)$ at \mathfrak{m} , so

$$\text{ord}_{\mathfrak{m}} F_I^*(ij|kl) = v(x_j - x_i) + v(x_k - x_l) - v(x_j - x_l) - v(x_k - x_i).$$

We will distinguish between the following cases:

- The situation is like in the first picture below. Then $\lambda = v(x_i - x_j)$ by Construction 2.2.20. Also $v(x_k - x_l) = v(x_l - x_j) = v(x_k - x_i) = 0$ which implies

$$v(F_I^*x) = v(x_i - x_j).$$

- Assume we are in the situation in the second picture below. Then $\lambda = v(x_i - x_j) - v(x_k - x_l)$ and $v(x_i - x_j) \geq v(x_k - x_l) \geq 0$ and $v(x_l - x_k) = v(x_l - x_j) = 0$. It follows that

$$v(F_I^*x) = v(x_i - x_j) - v(x_k - x_l).$$

- Assume we are in the situation on the right in the picture below, so $v(x_i - x_j) \geq v(x_k - x_l) \geq v(x_l - x_j) = v(x_k - x_l)$ and $\lambda = v(x_i - x_j) - v(x_k - x_l)$. The case where x_k and x_l are swapped in the graph works similar. So

$$v(F_I^*x) = v(x_i - x_j) - v(x_k - x_l).$$

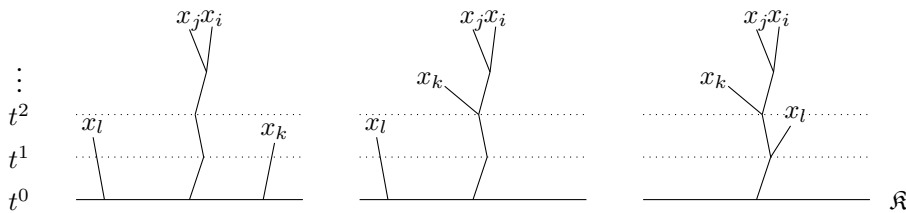

In any case we obtain that $\text{ord}_{\mathfrak{m}} F_I^*(ij|kl) = \lambda$, which proves the claim. \square

Together with Lemma 1.2.11 we can use the above lemma to uniquely determine the underlying abstract tropical curve. In the next lemma we want to describe how to recover the map into \mathbb{R}^m . Unfortunately I do not know how to do this using barycentric coordinates, so we will use approach (3) from Construction 1.2.20, i.e. we have two root leaves.

For let $\sigma \in \Sigma$ be a cone. Let $S_\sigma = \bigcup_{\tau \in \Sigma: \tau \geq \sigma} \tau(1) \setminus \sigma(1)$, then S_σ is in obvious bijection to $\text{Star}_\Sigma(\sigma)(1)$. We want to denote the images of the primitive generators u_ρ of the rays $\rho \in S_\sigma$ under the projection to \mathbb{R}^m/V_σ by f_ρ . These are then the primitive generators of the rays in $\text{Star}_\Sigma(\sigma)$.

Lemma 2.2.25. Consider a morphism $D_{\mathfrak{R}} \xrightarrow{\iota} W_{\Delta, Y}$ such that $\iota^{-1}W_{\Delta, Y}^{\circ} \neq \emptyset$. This corresponds to a family in $W_{\Delta, Y}^{\circ}$ over $D_{\mathfrak{R}}^*$, which by Construction 2.2.20 has a tropicalisation \mathcal{C} . Let σ be a cone of \mathcal{Y} and $\delta_k \in \Delta$ with $\delta_k \in \sigma^{\circ}$, f_{ρ} as above and $\text{EV}_k = \text{ev}_k \circ \iota$. Then we obtain the following relation between tropical and algebraic evaluation maps

$$(49) \quad \text{ev}_k^{V_{\sigma}}(\mathcal{C}) = \sum_{\rho \in \mathcal{S}_{\sigma}} \text{ord}_m \text{EV}_k^* D_{\rho} f_{\rho} \in \mathbb{R}^m / V_{\sigma}$$

PROOF. Let the restriction of the family to $D_{\mathfrak{R}}^*$ be as in Lemma 2.2.17, with β_{ρ} , $x_j \in \mathfrak{K}[[t]]$ and the morphism given by $(\pi_{\rho})_{\rho}$ with $\pi_{\rho} = \beta_{\rho} \prod_j (z_0 x_j - z_1)^{\alpha_{\rho}^j}$. Then EV_k is given by a tuple of power series $(\text{EV}_{k, \rho})_{\rho}$ in $\mathfrak{K}[[t]]$ with

$$\text{EV}_{k, \rho} = \begin{cases} \beta_{\rho} \prod_j (x_j - x_k)^{\alpha_{\rho}^j} & \text{if } \rho \notin \sigma(1) \\ 0 & \text{if } \rho \in \sigma(1) \end{cases}$$

on $D_{\mathfrak{R}}^*$. Let m_k be the smallest integer m such that $|I(m+1, k)| = 1$. As in Construction 2.2.21, we define

$$v_{\rho} = v(\beta_{\rho}) + \sum_{l=1}^{m_k} \sum_{l \in I(l, k)} \alpha_{\rho}^j$$

and we can see that v_{ρ} is the highest power of t that divides $\text{EV}_{k, \rho}$ if $\rho \notin \sigma(1)$. By Lemma 2.1.13 there is a unique cone $\tau \in \Sigma$ and a unique $(v_{\rho})_{\rho} \in \mathbb{Z}_{\geq 0}^{\Sigma(1)}$ with $(v_{\rho})_{\rho} \equiv (v_{\rho})_{\rho} \pmod{L_{\Sigma}}$ and $v_{\rho} > 0$ if and only if $\rho \in \tau(1)$. Then by Remark 2.1.7 the tuple of regular functions

$$(t^{v_{\rho} - v_{\rho}} \text{EV}_{k, \rho})_{\rho}$$

defines a morphism into $X(\Sigma)$ which extends $\text{EV}_k|_{D_{\mathfrak{R}}^*}$ to $D_{\mathfrak{R}}$ and therefore equals EV_k . Now it is obvious that

$$\text{ord}_m \text{EV}_k^* D_{\rho} = \begin{cases} v_{\rho} & \text{if } \rho \notin \sigma(1) \\ 0 & \text{if } \rho \in \sigma(1) \end{cases}.$$

Furthermore $(v_{\rho})_{\rho}$ is the point $\tilde{h}(V(m_k, k))$ from Construction 2.2.20 and $h(V(m_k, k)) = \sum_{\rho \in \tau(1)} v_{\rho} u_{\rho}$. As $V(m_k, k)$ is incident to the leaf x_k , we obtain $\text{ev}_k^{V_{\sigma}}(\mathcal{C}) = \sum_{\rho \in \tau(1) \setminus \sigma(1)} v_{\rho} f_{\rho}$. \square

Remark 2.2.26. In the following we will mostly be interested in the case of hyperplanes $\mathcal{Y} = L_{m-1}^m$. So we have to consider subvarieties $Y \subset \mathbb{P}^m$ with this tropicalisation. An obvious choice for Y are projective linear spaces of dimension $m-1$. So let now $Y \cong \mathbb{P}^{m-1}$ in which case we obtain a closed embedding $\overline{M}_{0, n}(\mathbb{P}^{m-1}, d) \cong \overline{M}_{0, n}(Y, d) \hookrightarrow \overline{M}_{0, n}(\mathbb{P}^m, d)$. There is a natural action of $G = \text{Aut}(\mathbb{P}^m)$ on $\overline{M}_{0, n}(\mathbb{P}^m, d)$ which sends $\overline{M}_{0, n}(Y, d)$ to $\overline{M}_{0, n}(gY, d)$ for every element $g \in G$. We also have $gW_{\Delta, Y}^{\circ} = W_{\Delta, gY}^{\circ}$ for those $g \in G$ which keep the coordinate hyperplanes fixed (diagonal matrices). So in particular $gW_{\Delta, Y} = W_{\Delta, gY}$. Every hyperplane which tropicalises to L_{m-1}^m is not contained in any coordinate hyperplane. Furthermore, two such hyperplanes can be mapped to each other by an element $g \in G$ fixing all coordinate hyperplanes. We conclude that all possible $W_{\Delta, Y}$ are isomorphic in this case, for a fixed Δ and $Y \cong \mathbb{P}^{m-1}$.

Example 2.2.27. Consider the degree $\Delta = (2e_1 + 3e_2, e_0 + e_1, e_0 + 2e_3, e_3, e_0)$ and the hyperplane $H = Z(\sum_{i=0}^3 y_i) \subset \mathbb{P}^3 = \text{Proj } \mathbb{C}[y_0, y_1, y_2, y_3]$. Furthermore let H_0, \dots, H_3 denote the coordinate hyperplanes. Computations as in Remark 2.3.5 will show that we have $\dim W_{\Delta, H} = 1$. The same kind of computation yields a one dimensional family in $W_{\Delta, H}^{\circ}$ with limit a curve $\mathcal{C} = (C, x_1, \dots, x_5, \pi) \in \partial W_{\Delta, H}$ as follows: The curve C has three irreducible components C_1 with marked points x_2 and x_3 , C_2 with marked points x_4 and x_5 and C_3 with marked point x_1 . Here C_1 intersects C_3 in a node and also C_2 intersects C_3 in a node. The morphism π has degree two on C_1 , hence it is embedded as a conic, it has degree one on C_2 and it maps onto the line H_2 , furthermore it is constant on C_3 . The picture below

shows the image $\pi(C)$ in $H \cong \mathbb{P}^2$ on the left. By the correspondence from Theorem 2.2.18 this belongs to the tropical combinatorial type depicted on the right.

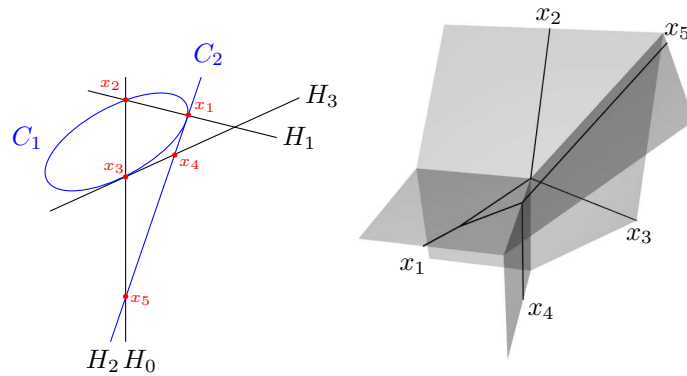

There is also another one dimensional family $W' \subset \overline{M}_{0,5}(H, 3)$ of curves in $M_{\Delta, H}$. In the above picture this family is given by moving the image of C_2 but requiring that it passes through $H_1 \cap H_2$. Then W' also contains the curve C' depicted below.

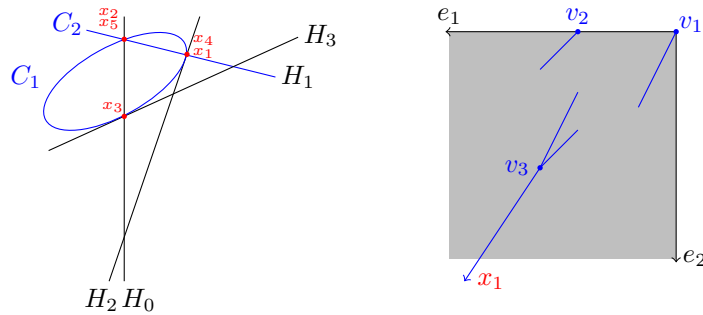

By Proposition 2.2.12 the stable map C' corresponds to a quasi-resolution of Δ , which we already saw in Example 2.2.9. The picture shows the situation only inside the cone σ_{12} . We see that the vertices fit together pairwise but not all at the same time, hence we do not obtain a corresponding combinatorial type of tropical curves in L_2^3 . So by Theorem 2.2.18 we can conclude that C' cannot be the limit of a family of *irreducible* curves in $W_{\Delta, H}$. There is another interesting curve in $W_{\Delta, H}$, namely the one from Example 2.2.22. It corresponds to the tropical combinatorial type below.

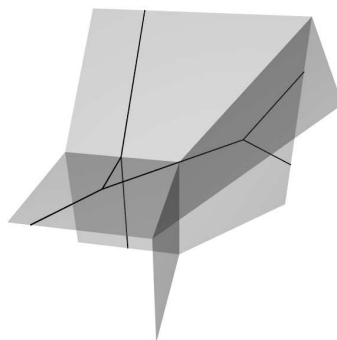

The tropical curve passes through the origin with a weight two edge, but we would *expect* that such a curve is locally not realisable at the origin (cf. Example 2.3.7). The vertex type of the vertex that is mapped to the origin has resolution dimension -1 , hence the combinatorial type is *not admissible* in the sense of Definition 1.5.8.

Example 2.2.28. Consider the degree $\Delta = (e_1 + e_2, e_1 + 2e_2, e_3, 2e_0 + 2e_3, e_0 + e_1)$ for curves in L_2^3 , let $H \subset \mathbb{P}^3$ be as in the previous example and let H_0, \dots, H_3 denote the coordinate hyperplanes. A computation as in Remark 2.3.5 will show that $W_{\Delta, H} = \emptyset$ even though we would expect (cf. Construction 2.3.3) it to be one dimensional. Consider the combinatorial type γ of degree Δ curves in L_2^3 from the picture below.

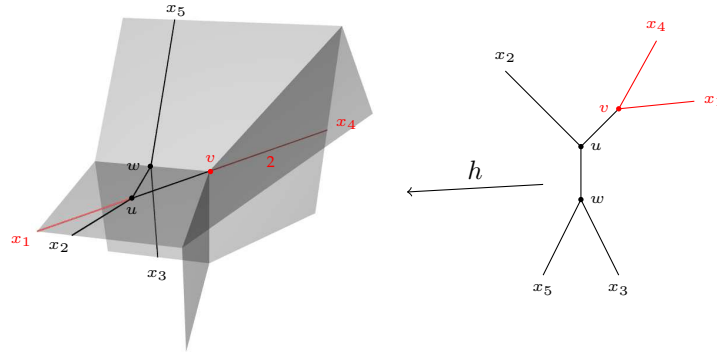

In the picture the red number 2 means that the edge is of this weight. As $\partial W_{\Delta, H} = \emptyset$, there is no algebraic stable map of combinatorial type γ . However, for each vertex of γ we can find a corresponding algebraic stable map: We have that $W_{\Delta, v, H} \neq \emptyset$ by Example 2.3.7. To w there corresponds a degree one cover of the line $H \cap H_1$ and to u corresponds a degree zero map to the point $H \cap H_1 \cap H_2$.

Example 2.2.29 (Rational curves on the Hirzebruch surface). In this example we want to consider two different curves $Y_1, Y_2 \subset \mathbb{F}_n$. The fan of \mathbb{F}_n is generated by $u_{\rho_1} = ne_2 - e_1, u_{\rho_2} = e_2, u_{\rho_3} = e_1$ and $u_{\rho_4} = -e_2$ as depicted below. Consider the maps

$$\pi_1(z_0 : z_1) = (z_0 : 1 : z_1 : (z_1 - z_0)^n) \text{ and } \pi_2(z_0 : z_1) = (z_0 : 1 : z_1 : \prod_{i=1}^n (x_i z_0 - z_1))$$

where the homogeneous coordinates of \mathbb{F}_n are ordered the same way as the generators and the $x_i \in \mathbb{C}^*$ are pairwise distinct. One can see that $Y_1 := \pi_1(\mathbb{P}^1)$ and $Y_2 := \pi_2(\mathbb{P}^1)$ both tropicalise to \mathcal{Y} which consists of the cones ρ_1, ρ_3 and ρ_4 with weights 1, 1 and n respectively.

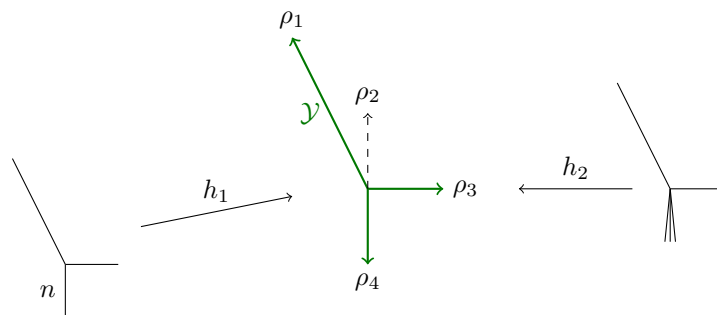

Consider the degrees $\Delta_1 = (u_{\rho_3}, nu_{\rho_4}, u_{\rho_1})$ and $\Delta_2 = (u_{\rho_3}, u_{\rho_4}, \dots, u_{\rho_4}, u_{\rho_1})$. The picture above shows \mathcal{Y} as subfan of the fan of \mathbb{F}_n in green and also shows the abstract graphs of the tropical stable maps of degrees Δ_1 and Δ_2 corresponding to $(\mathbb{P}^1, 0, 1, \infty, \pi_1)$ and $(\mathbb{P}^1, 0, x_1, \dots, x_n, \infty, \pi_2)$ according to Theorem 2.2.18. Recall that by definition of W_{Δ_i, Y_i} all intersections with boundary divisors are marked. As Y_1 has only *one* intersection point with D_{ρ_4} (of multiplicity n) while Y_2 intersects D_{ρ_4} n times with multiplicity one, it follows that $W_{\Delta_1, Y_2} = \emptyset = W_{\Delta_2, Y_1}$, while $W_{\Delta_i, Y_i} \neq \emptyset$ for $i = 1, 2$. In particular this example shows that the space $W_{\Delta, Y}$ in general *depends on* Y and not just the tropicalisation \mathcal{Y} .

2.3. The virtual fundamental class

As we saw in the previous section, $W_{\Delta, Y}$ encodes combinatorial types of degree Δ curves in \mathcal{Y} . However, we also saw that this space is not well behaved. By Example 2.2.28, there is no hope for the boundary $\partial W_{\Delta, Y}$ to have any sort of recursive structure in the way the boundary of $\overline{M}_{0, n}(X, \beta)$ has. Also, the combinatorial types which can occur are not always admissible in the sense of Section 1.5, as shown in Example 2.2.22. Furthermore, we will see in Example 2.3.7 that the expected dimension of $W_{\Delta, Y}$ is not always equal to its actual dimension, which makes it difficult to do intersection theory on $W_{\Delta, Y}$. Which dimension the expected one is, will be discussed in Construction 2.3.3. The usual solution to this dimension issue is to define a virtual fundamental class $[W_{\Delta, Y}]^{vir}$, which will be the goal of this section.

Lemma 2.3.1. *Let $n = |\Delta| \geq 3$ and $m = \dim X(\Sigma)$, then $W_{\Delta, X(\Sigma)}^\circ \cong M_{0, n} \times T^m$, where T^m is the m -dimensional torus over \mathbb{C} . In particular $W_{\Delta, X(\Sigma)}^\circ$ is smooth and of dimension $|\Delta| + \dim X(\Sigma) - 3$.*

PROOF. The idea of the proof is easy: as we saw several times, a curve in $W_{\Delta, X(\Sigma)}^\circ$ over \mathbb{C} is given by a tuple of homogeneous polynomials in two variables. These are uniquely determined by their zeroes (n marked points) and scalars in \mathbb{C}^* (up to action of the torus G_Σ from (26), their number is m). Nevertheless, this needs to be formalised. Fix a maximal cone $\sigma \in \Sigma(m)$, let $T^m = \text{Spec } \mathbb{C}[\beta_\rho^{\pm 1} \mid \rho \in \sigma(1)]$, $\beta_\rho := 1$ for $\rho \notin \sigma(1)$ and $\mathcal{M} := M_{0, n} \times T^m$. First we want to describe the universal family over \mathcal{M} . Let $\mu : \mathcal{M} \rightarrow M_{0, n}$ and $\tau : \mathcal{M} \rightarrow T^m$ denote the projections. Let $(\mathbb{P}_{M_{0, n}}^1, p, M_{0, n}, x_1, \dots, x_n)$ be the universal family over $M_{0, n}$. Let $\mathcal{U} := \mathcal{M} \times \mathbb{P}^1$ and let $\tilde{p} : \mathcal{U} \rightarrow \mathcal{M}$ and $\overline{\mu} : \mathcal{U} \rightarrow \mathbb{P}_{M_{0, n}}^1$ denote the projections. Then the right square in the following commutative diagram is Cartesian.

$$\begin{array}{ccccc}
 & & \overline{\varphi} & & \\
 & & \curvearrowright & & \\
 \mathcal{C} & \xrightarrow{\overline{\Phi}} & \mathcal{U} & \xrightarrow{\overline{\mu}} & \mathbb{P}_{M_{0, n}}^1 \\
 \hat{p} \downarrow & & \tilde{p} \downarrow & & p \downarrow \\
 S & \xrightarrow{\Phi} & \mathcal{M} & \xrightarrow{\mu} & M_{0, n} \\
 & & \curvearrowleft & & \\
 & & \varphi & &
 \end{array}$$

The rest of the diagram will be explained below. As the right square is Cartesian, we obtain pull back sections $\tilde{x}_j : \mathcal{M} \rightarrow \mathcal{U}$ from the x_j . Let $\mathcal{H}_\rho := \mathcal{O}_{\mathbb{P}_{M_{0, n}}^1}(\sum_j \alpha_\rho^j x_j)$ and fix canonical sections $s_\rho \in \Gamma(\mathbb{P}_{M_{0, n}}^1, \mathcal{H}_\rho)$ representing the Cartier divisors $\sum_j \alpha_\rho^j x_j$. Furthermore fix trivialisations $c_\lambda : \bigotimes_\rho \mathcal{H}_\rho^{(\lambda, u_\rho)} \xrightarrow{\sim} \mathcal{O}_{\mathbb{P}_{M_{0, n}}^1}$ for all $\lambda \in \Lambda^\vee$. Clearly $\tau^* \beta_\rho$ is a global section of $\mathcal{O}_{\mathcal{M}}^*$ and hence $(\overline{\mu}^* s_\rho)(\tilde{p}^* \tau^* \beta_\rho) =: \tilde{\pi}_\rho$ is a global section of $\overline{\mu}^* \mathcal{H}_\rho = \mathcal{O}_{\mathcal{U}}(\sum_j \alpha_\rho^j \tilde{x}_j)$. Let \tilde{c}_λ denote the trivialisations that are induced from c_λ via pull back along $\overline{\mu}$. Then $(\overline{\mu}^* \mathcal{H}_\rho, \tilde{\pi}_\rho, \tilde{c}_\lambda)$ is a Σ -collection which yields a morphism $\tilde{\pi} : \mathcal{U} \rightarrow X(\Sigma)$ by Lemma 2.1.4. By construction $(\mathcal{U}, \tilde{p}, \mathcal{M}, \tilde{x}_1, \dots, \tilde{x}_n, \tilde{\pi})$ is a family in $W_{\Delta, X(\Sigma)}^\circ$.

Now consider any family $(\mathcal{C}, \hat{p}, S, \hat{x}_1, \dots, \hat{x}_n, \hat{\pi})$ in $W_{\Delta, X(\Sigma)}^\circ$. By the universal property of $M_{0, n}$ the family $(\mathcal{C}, \hat{p}, S, \hat{x}_1, \dots, \hat{x}_n)$ is isomorphic to the pull back of the universal family over $M_{0, n}$ via some morphism $\varphi : S \rightarrow M_{0, n}$. Let $\overline{\varphi} : \mathcal{C} \rightarrow \mathbb{P}_{M_{0, n}}^1$ denote the morphism induced by φ . So also the outer square in the above diagram is Cartesian. By Lemma 2.1.4 and definition of $W_{\Delta, X(\Sigma)}^\circ$, the morphism $\hat{\pi}$ is given by a Σ -collection $(\hat{\mathcal{H}}_\rho, \hat{\pi}_\rho, \hat{c}_\lambda)$, where $\hat{\pi}_\rho$

is a global section of $\hat{\mathcal{H}}_\rho = \mathcal{O}_{\mathcal{C}} \left(\sum_j \alpha_\rho^j \hat{x}_j \right)$ which cuts out $\sum_j \alpha_\rho^j \hat{x}_j$. As $\overline{\varphi}^* x_j = \hat{x}_j$ for the divisors given by the images of the sections, we conclude $\overline{\varphi}^* \mathcal{H}_\rho = \hat{\mathcal{H}}_\rho$. Let c'_λ denote the trivialisations that are obtained from c_λ via pull back along $\overline{\varphi}$. As in the proof of Lemma 2.1.4 or in Example 2.1.5 we obtain global sections ω_ρ of $\mathcal{O}_{\mathcal{C}}^*$ such that $c'_\lambda = \left(\prod_\rho \omega_\rho^{\langle \lambda, u_\rho \rangle} \right) \hat{c}_\lambda$ holds for all $\lambda \in \Lambda^\vee$. Then $(\hat{\mathcal{H}}_\rho, \omega_\rho \hat{\pi}_\rho, c'_\lambda)$ is equivalent to $(\hat{\mathcal{H}}_\rho, \hat{\pi}_\rho, \hat{c}_\lambda)$ and hence also defines $\hat{\pi}$. For each ρ the sections $\omega_\rho \hat{\pi}_\rho$ and $\overline{\varphi}^* s_\rho$ define the same cycle $\sum_j \alpha_\rho^j \hat{x}_j$ on \mathcal{C} , therefore they differ only by a global section $\tilde{\beta}_\rho$ of $\mathcal{O}_{\mathcal{C}}^*$. Using Remark 2.1.6 we can assume $\tilde{\beta}_\rho = 1$ for $\rho \notin \sigma(1)$. Then the remaining $\tilde{\beta}_\rho$ are uniquely determined. As the fibres of \hat{p} are \mathbb{P}^1 , the sections $\tilde{\beta}_\rho$ must be constant on fibres and hence there are global sections $\hat{\beta}_\rho$ of \mathcal{O}_S^* with $\hat{p}^* \tilde{\beta}_\rho = \tilde{\beta}_\rho$. The $(\hat{\beta}_\rho)_{\rho \in \sigma(1)}$ define a morphism $\phi : S \rightarrow T^m$ with $\phi^* \beta_\rho = \hat{\beta}_\rho$ for all $\rho \in \Sigma(1)$. So we obtain morphisms $\Phi := \varphi \times \phi : S \rightarrow \mathcal{M}$ and $\overline{\Phi} = \overline{\varphi} \times \phi$. With these morphisms also the left square is Cartesian. We also have $\tau \circ \tilde{p} \circ \overline{\Phi} = \tau \circ \Phi \circ \hat{p} = \phi \circ \hat{p}$, which implies $\overline{\Phi}^* (\tilde{p}^* \tau^* \beta_\rho) = \hat{p}^* \phi^* \beta_\rho = \hat{p}^* \hat{\beta}_\rho$. Furthermore $\overline{\Phi}^* \overline{\mu}^* s_\rho = \overline{\varphi}^* s_\rho$ and we obtain $\omega_\rho \hat{\pi}_\rho = (\overline{\varphi}^* s_\rho)(\hat{p}^* \hat{\beta}_\rho) = \overline{\Phi}^* ((\overline{\mu}^* s_\rho)(\hat{p}^* \tau^* \beta_\rho)) = \overline{\Phi}^* \tilde{\pi}_\rho$. As $\overline{\varphi} = \overline{\mu} \circ \overline{\Phi}$, we conclude that $\overline{\Phi}^* \overline{\mu}^* \mathcal{H}_\rho = \hat{\mathcal{H}}_\rho$ and that c'_λ is also the trivialisations induced by \hat{c}_λ via pull back along $\overline{\Phi}$. Hence $\hat{\pi} = \tilde{\pi} \circ \overline{\Phi}$. This means the family $(\mathcal{C}, \hat{p}, S, \hat{x}_1, \dots, \hat{x}_n, \hat{\pi})$ is isomorphic to the pull back of the universal family over \mathcal{M} along Φ . \square

Lemma 2.3.2. *Assume we have an integral hypersurface $Y \subset X(\Sigma)$ with tropicalisation \mathcal{Y} , a subfan of Σ . If $[Y] = \sum_{\rho \in \Sigma(1)} c_\rho D_\rho$ in $A_{m-1}(X(\Sigma))$ then the tropical rational function $\varphi = \sum_{\rho \in \Sigma(1)} c_\rho \Psi_\rho$ (cf. Definition 1.3.9) satisfies $\varphi \cdot \mathbb{R}^m = \mathcal{Y}$. In particular $\mathcal{O}_{X(\Sigma)}(Y)$ is generated by global sections.*

PROOF. By Lemma 2.3 of [KP11], the weight $\omega_{\mathcal{Y}}(\tau)$ of a maximal cone of \mathcal{Y} is given by

$$\omega_{\mathcal{Y}}(\tau) = \deg[Y] \cdot V(\tau) = \deg \sum_{\rho} c_\rho D_\rho \cdot [V(\tau)] = \sum_{\rho} c_\rho \deg D_\rho \cdot [V(\tau)].$$

Let $\rho_1(\tau)$ and $\rho_2(\tau)$ denote the two unique rays that span maximal cones σ_1 and σ_2 of Σ together with τ . We fix a maximal $\sigma > \tau$ for the rest of this proof, say $\sigma = \sigma_1$. We need to distinguish between three different cases. The first one is that ρ and τ do not span a cone in Σ , then $\deg D_\rho \cdot [V(\tau)] = 0$. The second one is that ρ and τ span a maximal cone of Σ , then $\deg D_\rho \cdot [V(\tau)] = 1$. The last case is that $\rho \in \tau(1)$, where we need to replace $D_\rho = -\sum_{\rho' \notin \sigma_1(1)} m(\sigma_1)_{\rho'}^{\rho'} D_{\rho'}$ (cf. formula (31)). This equality comes from $\text{div}(\chi^{\lambda_\rho}) = 0$ where $(\lambda_\rho)_{\rho \in \sigma_1(1)}$ is the dual basis of $(u_\rho)_{\rho \in \sigma_1(1)}$. After replacing $D_{\rho'}$, we have reduced the problem to the first two cases. Adding everything up we obtain

$$\omega_{\mathcal{Y}}(\tau) = c_{\rho_1(\tau)} + c_{\rho_2(\tau)} - \sum_{\rho \in \tau(1)} c_\rho m(\sigma_1)_{\rho}^{\rho_2(\tau)}$$

where the first two summands are coming from case one and the sum results from case three.

If we compute $\omega_{\varphi \cdot \mathbb{R}^m}(\tau)$ using formula (8) we can choose $v_{\sigma_i/\tau} = u_{\rho_i(\tau)}$ for $i = 1, 2$ and obtain

$$v_{\sigma_1/\tau} + v_{\sigma_2/\tau} = \sum_{\rho \in \tau(1)} m(\sigma_1)_{\rho}^{\rho_2(\tau)} u_\rho \in V_\tau.$$

Plugging this into the formula (8), we see immediately that $\omega_{\mathcal{Y}}(\tau) = \omega_{\varphi \cdot \mathbb{R}^m}(\tau)$ for all $\tau \in \Sigma(m-1)$.

The line bundle is generated by global sections by Theorem 6.3.12 of [CLS11], as the intersection numbers $[Y] \cdot V(\tau) = \omega_{\mathcal{Y}}(\tau)$ are non-negative for all τ of codimension one, i.e. all torus invariant irreducible curves. \square

Construction 2.3.3 (The vector bundle E_Y). We will imitate a construction from Kontsevich's celebrated paper [Kon]. Let $Y \subset X(\Sigma)$ be a hypersurface such that its tropicalisation \mathcal{Y} is a subfan of Σ , and let Δ be the degree of a tropical fan curve. Furthermore we want to assume that $\mathcal{O}_{X(\Sigma)}(Y)$ is generated by global sections and that there is a global section $y \in \Gamma(X(\Sigma), \mathcal{O}_{X(\Sigma)}(Y))$ with $Z(y) = Y$. If for example Y is integral, these two conditions are ensured by Lemmas 2.1.10 and 2.3.2. We want to describe the locus of curves in $\overline{M}_{0,n}(X(\Sigma), \beta_\Delta)$ which lie in Y as the zero locus of a global section of some vector bundle E_Y on $\overline{M}_{0,n}(X(\Sigma), \beta_\Delta)$. If $f : \mathcal{U} \rightarrow \overline{M}_{0,n}(X(\Sigma), \beta_\Delta)$ denotes the universal family with morphism $\pi : \mathcal{U} \rightarrow X(\Sigma)$, then we want to define $\mathcal{E}_Y := f_* \pi^* \mathcal{O}_{X(\Sigma)}(Y)$. This is a sheaf on $\overline{M}_{0,n}(X(\Sigma), \beta_\Delta)$ which assigns to a family $(C, f^S, S, x_1, \dots, x_n, \pi_S)$ the $\mathcal{O}_S(S)$ -module $\Gamma(S, f_* \pi_S^* \mathcal{O}_{X(\Sigma)}(Y))$.

Now we want to see that this is a locally free sheaf. The restriction of $\pi_S^* \mathcal{O}_{X(\Sigma)}(Y)$ to a fibre C_s of f^S over $s \in S$ is $(\pi_S)_s^* \mathcal{O}_{X(\Sigma)}(Y)$. It is easy to see that a line bundle on a nodal genus zero curve which is generated by global sections has no higher cohomology because this is true for the irreducible components, which are \mathbb{P}^1 s. From this the statement follows by "gluing" the restrictions to the irreducible components to the original line bundle. As $\mathcal{O}_{X(\Sigma)}(Y)$ is generated by global sections, we obtain $H^1(C_s, (\pi_S)_s^* \mathcal{O}_{X(\Sigma)}(Y)) = 0$. Knowing this, the Riemann-Roch-Theorem for nodal curves ([Ful98], Example 18.3.4) yields

$$h^0(C_s, (\pi_S)_s^* \mathcal{O}_{X(\Sigma)}(Y)) = \deg(\pi_S)_s^* \mathcal{O}_{X(\Sigma)}(Y) + 1.$$

But the degree of the line bundle is constant in flat families of curves, hence also the number $h^0(C_s, (\pi_S)_s^* \mathcal{O}_{X(\Sigma)}(Y))$ is constant on S . By [Har97] III, Corollary 12.9 it follows that $f_* \pi_S^* \mathcal{O}_{X(\Sigma)}(Y)$ is a locally free sheaf of rank $h^0(C_s, (\pi_S)_s^* \mathcal{O}_{X(\Sigma)}(Y))$ as f^S is flat. In particular, if we choose S as an atlas (cf. Definition 3.1 in [Gil84]) of $\overline{M}_{0,n}(X(\Sigma), \beta_\Delta)$ we see that \mathcal{E}_Y is locally free, cf. Definition 7.1 of [Gil84]. Therefore there is also an associated vector bundle $E_Y \rightarrow \overline{M}_{0,n}(X(\Sigma), \beta_\Delta)$, cf. Definition 1.18 of [Vis89].

Now we want to show that if Y is integral, the vector bundle E_Y is actually of rank $K_{\mathcal{Y}} \cdot \Delta + 1$. For this we restrict to a smooth curve $(\mathbb{P}^1, x_1, \dots, x_n, \pi)$. By Lemma 2.3.2 we have that $\mathcal{O}_{X(\Sigma)}(Y) \cong \mathcal{O}_{X(\Sigma)}(\sum_\rho c_\rho D_\rho)$ and $\mathcal{Y} = \varphi \cdot \mathbb{R}^m$ with $\varphi = \sum_\rho c_\rho \Psi_\rho$. Hence the canonical divisor is $K_{\mathcal{Y}} = \varphi|_{\mathcal{Y}}$ and $K_{\mathcal{Y}} \cdot \Delta = \sum_\rho c_\rho \deg \Psi_\rho \cdot \Delta = \sum_\rho c_\rho d_\rho$, where Δ also stands for the canonical tropical fan defined by it. On the other hand $\pi^* \mathcal{O}_{X(\Sigma)}(D_\rho) \cong \mathcal{O}_{\mathbb{P}^1}(d_\rho)$ by Lemma 2.1.4, which means $\pi^* \mathcal{O}_{X(\Sigma)}(Y) \cong \mathcal{O}_{\mathbb{P}^1}(\sum_\rho c_\rho d_\rho)$, so we conclude $h^0(C, \pi^* \mathcal{O}_{X(\Sigma)}(Y)) = \sum_\rho c_\rho d_\rho + 1 = K_{\mathcal{Y}} \cdot \Delta + 1$.

If y is a global section of $\mathcal{O}_{X(\Sigma)}(Y)$ with $Z(y) = Y$, we denote $s_Y := f_* \pi^* y$ which is a global section of E_Y . If we restrict E_Y to $W_{\Delta, X(\Sigma)}$, we have $Z(s_Y)_{\text{red}} = W_{\Delta, Y}$ for the zero locus of the restricted section. From this, the rank of E_Y and the dimension of $W_{\Delta, X(\Sigma)}$ we would expect $W_{\Delta, Y}$ to be of dimension

$$(50) \quad \text{vdim}(\mathcal{Y}, \Delta) = \dim \mathcal{Y} + |\Delta| - K_{\mathcal{Y}} \cdot \Delta - 3,$$

the virtual dimension of the vertex type from Definition 1.5.6.

Definition 2.3.4 (Virtual class). Let the notation be as in Construction 2.3.3. We also denote the restriction of E_Y to the stack $W_{\Delta, X(\Sigma)}$ by E_Y . We obtain a fibre square

$$\begin{array}{ccc} Z(s_Y) & \longrightarrow & W_{\Delta, X(\Sigma)} \\ \downarrow & & \downarrow s_Y \\ W_{\Delta, X(\Sigma)} & \xrightarrow{\quad 0 \quad} & E_Y \end{array}$$

where 0 denotes the zero section. As $Z(s_Y)_{\text{red}} = W_{\Delta, Y}$ we can define the *virtual fundamental class* as

$$[W_{\Delta, Y}]^{\text{vir}} := 0^! [W_{\Delta, X(\Sigma)}] \in A_{\text{vdim}(\mathcal{Y}, \Delta)}(W_{\Delta, Y})_{\mathbb{Q}}.$$

Note that push forward along the closed embedding $\iota : W_{\Delta, Y} \hookrightarrow W_{\Delta, X(\Sigma)}$ yields the intersection with the top Chern class $\iota_* [W_{\Delta, Y}]^{vir} = c_{top}(E_Y) \cap [W_{\Delta, X(\Sigma)}]$.

Remark 2.3.5 (E_H for hyperplanes $H \subset \mathbb{P}^m$). Consider the hyperplane $H = Z(\sum_{i=0}^m y_i) \subset \mathbb{P}^m = \text{Proj } \mathbb{C}[y_0, \dots, y_m]$ whose intersection with the dense torus tropicalises to L_{m-1}^m and a degree Δ of tropical curves in L_{m-1}^m such that $|\Delta| \geq 3$. We know by Lemma 2.3.1 that $W_{\Delta, \mathbb{P}^m}^\circ \cong M_{0,n} \times T^m$. We will fix coordinates on \mathbb{P}^1 and we fix the coordinates for three arbitrary marked points, say $x_1, x_2, x_3 \in \mathbb{C}$. This also fixes the automorphisms of \mathbb{P}^1 and we can consider the open subscheme $U \subset M_{0,n}$ of curves where no marked point equals ∞ . We can then use the positions of the marked points x_j as coordinates and consider U as open subscheme of $\mathbb{A}^{n-3} = \text{Spec } \mathbb{C}[x_4, \dots, x_n]$.

As in Lemma 2.3.1 the restriction of the universal family to $U \times T^m$ is given by the projection $\text{pr} : U \times T^m \times \mathbb{P}^1 \rightarrow U \times T^m$ and the morphism π to \mathbb{P}^m is given by a tuple of polynomials

$$(51) \quad \left(\beta_i \prod_{j=1}^n (x_j z_0 - z_1)^{\alpha_j^i} \right)_i$$

where $\beta_i = 1$ for some fixed i .

Let $h = \sum_{i=0}^m y_i$, which is a global section of $\mathcal{O}(H)$ with zero scheme H . Then the pull back $\pi^* h$ is a global section of $\pi^* \mathcal{O}(H)$ and is of the form

$$(52) \quad \pi^* h|_{\mathbb{P}^1 \times T^m} = \sum_{i=0}^m \beta_i \prod_{j=1}^n (x_j z_0 - z_1)^{\alpha_j^i}.$$

The coefficients of this polynomial in z_0 and z_1 are the global section $s_H = f_* \pi^* h$ of the bundle $f_* \pi^* \mathcal{O}(H) = E_H$ restricted to $U \times T^m$.

We will determine these coefficients via a Taylor series expansion. Defining $z^{(j)} = x_j z_0 - z_1$ we obtain $\frac{d}{dz_1} f(z^{(j)}) = -\frac{d}{dz^{(j)}} f(z^{(j)})$. We can use this to compute

$$\frac{d}{dz_1} \prod_j f_j(z^{(j)}) = \sum_l \left(-\frac{d}{dz^{(l)}} f_l(z^{(l)}) \right) \prod_{j \neq l} f_j(z^{(j)}) = -\sum_l \frac{d}{dz^{(l)}} \prod_j f_j(z^{(j)}),$$

so $\frac{d}{dz_1} = -\sum_l \frac{d}{dz^{(l)}}$. If we interpret (52) as $\pi^* h = F(z_1)$, we can compute the coefficients $\frac{1}{r!} \left(\frac{d}{dz_1} \right)^r F(z_1)|_{z_1=0}$ of the Taylor polynomial of $F(z_1)$. We want to abbreviate $T_i = \prod_j x_j^{\alpha_j^i}$ and $D = \sum_j \partial_{x_j}$. It is now easy to see that with this notation

$$(53) \quad \frac{1}{r!} \left(\frac{d}{dz_1} \right)^r F(z_1)|_{z_1=0} = (-1)^r \frac{1}{r!} z_0^{d-r} \sum_{i=0}^m \beta_i D^r T_i.$$

So we finally see that $s_H|_{U \times T^m}$ is given by

$$(54) \quad s_H|_{U \times T^m} = \left(\frac{(-1)^r}{r!} \sum_{i=0}^m \beta_i D^r T_i \right)_{0 \leq r \leq d}$$

Therefore $(U \times T^m) \cap W_{\Delta, H}^\circ$ is given by the solution of the equations (54), where we can omit the factors $\frac{(-1)^r}{r!}$ if we want to compute the zero scheme. If $Z(s_H) \cap \partial W_{\Delta, \mathbb{P}^m} = \emptyset$, we can use (54) to actually compute $c_{top}(E_H) \cap [W_{\Delta, \mathbb{P}^m}] = [Z(s_H)] = [W_{\Delta, H}]^{vir}$ and its degree. If $Z(s_H) \cap W_{\Delta, \mathbb{P}^m}^\circ \neq \emptyset$, we can use (54) to find families in $W_{\Delta, H}^\circ$ as the one from Example 2.2.22. Such families can then be used to determine elements in $\partial W_{\Delta, H}$.

Note that we might miss some stable maps in $W_{\Delta, H}^\circ$ as there could be stable maps with some $x_j = \infty$ on the underlying curve. To make sure we find all smooth stable curves, we need to do two computations with different choices of for the fixed coordinates of x_1, x_2, x_3 (which then also gives another choice for ∞). The reason why we did not fix one of the marked points to be ∞ in the above computations, is that the equations look nicer this way.

Example 2.3.6. Consider the degree $\Delta = (2e_2 + e_3, e_1 + e_3, 2e_0 + e_1)$ of curves in L_2^3 and a hyperplane $H \subset \mathbb{P}^3$ which tropicalises to L_2^3 . We have that $\text{vdim}(L_2^3, \Delta) = 0$ and $Z(s_H) \cap \partial W_{\Delta, \mathbb{P}^3} = \emptyset$ for the global section of the bundle E_H . We want to use Remark 2.3.5 to show that $\deg c_{\text{top}}(E_H) \cap [W_{\Delta, \mathbb{P}^3}] = \deg [W_{\Delta, H}]^{\text{vir}} = 1$. In this example we obtain that $Z(s_H)$ is the zero scheme of the following equations

$$\begin{aligned} \beta_0 x_3^2 + \beta_1 x_3 x_2 + \beta_2 x_1^2 + \beta_3 x_1 x_2 &= 0 \\ 2\beta_0 x_3 + \beta_1(x_3 + x_2) + 2\beta_2 x_1 + \beta_3(x_1 + x_2) &= 0 \\ 2\beta_0 + 2\beta_1 + 2\beta_2 + 2\beta_3 &= 0. \end{aligned}$$

Fixing values for x_1, x_2, x_3 and $\beta_0 = 1$ this becomes a linear system of equations having one solution which is then of multiplicity one.

For the tropical degree $\Delta' = (2e_3, e_1 + 2e_2, 2e_0 + e_1)$ we also have $\text{vdim}(L_2^3, \Delta') = 0$ and by a very similar computation we obtain $\deg [W_{\Delta', H}]^{\text{vir}} = 1$ also in this case.

Example 2.3.7. The expected dimension is not always equal to the actual dimension. Consider the two tropical degrees $\Delta = (2e_0 + 2e_1, 2e_2 + 2e_3)$ and $\Delta' = (2e_0 + 2e_1, e_2 + e_3, e_2 + e_3)$ in L_2^3 . The expected dimensions are -1 and 0 , respectively. So we would expect $W_{\Delta, H} = \emptyset$, but it consists of a degree two cover of the line through $H_0 \cap H_1$ and $H_2 \cap H_3$, where the H_i denote the planes at infinity in \mathbb{P}^3 . Also $\dim W_{\Delta', H} = 1$, consisting of degree two covers of the same line where one simple unmarked ramification is free to move.

2.4. Boundary behaviour of $W_{\Delta, Y}$

As we saw in Section 2.2, the multiplicities of certain Cartier divisors to the boundary of $W_{\Delta, Y}$ encode combinatorial types of degree Δ curves in \mathcal{Y} . Therefore we will investigate properties of the boundary of $W_{\Delta, Y}$ in this section. We will mostly restrict to the case $Y = X(\Sigma)$, as this is easier to understand than the general case. As a tool we will consider suitable refinements $\tilde{\Sigma}$ of the fan Σ and the induced morphisms $X(\tilde{\Sigma}) \rightarrow X(\Sigma)$ and $W_{\Delta, X(\tilde{\Sigma})} \rightarrow W_{\Delta, X(\Sigma)}$.

In the moduli spaces $\overline{M}_{0, n}(X, \beta)$ and $\overline{M}_{0, n}$ the boundary divisors have a recursive structure, i.e. they are a fibre product over spaces of the same type. The hope is that we can say something similar about $W_{\Delta, X(\Sigma)}$. Therefore, we start with the following definition of fibre products over graphs.

Definition 2.4.1 (Fibre product over a graph). Let G be a connected graph. Assume for every vertex v of G we have some scheme (or stack) X_v and for every flag $f \in F^v$ which is incident to v we have a morphism $e_f : X_v \rightarrow Y_f$ such that if $\{f, f'\}$ is an edge of G we have $Y_f = Y_{f'}$.

Fix a vertex w of G . Let $E = \{\{f'_i, f_i\} \mid i = 1, \dots, r\}$ be the set of all edges of G that are adjacent to w , where $\partial_G(f_i) = w$ and $\partial_G(f'_i) = w_i$ for $i = 1, \dots, r$. Let G_1, \dots, G_r be those graphs which are obtained by cutting G at the edges E , i.e. the elements of $\mathcal{G}(G, E)$ (cf. Construction 1.5.4), except the graph that only has the vertex w . Let now $M_0 := X_w$ and define inductively

$$M_i := \left(\prod_{G_i, (Y_f)_f} X_v \right) \times_{Y_{f_i}} M_{i-1}.$$

We assume by induction of the number of vertices that $\prod_{G_i, (Y_f)_f} X_v$ is already defined. We take the product over the morphisms which are induced by $e_{f'_i} : X_{w_i} \rightarrow Y_{f_i}$ and $e_{f_i} : X_w \rightarrow Y_{f_i}$. We then define $\prod_{G, (Y_f)_f} X_v := M_r$. Using the universal property of the usual fibre product it is not difficult though quite cumbersome to see that this only depends on G and on the morphisms e_f , not on the choice of w or the order of the G_i .

Assume that all e_f are smooth morphisms, all X_v are schemes and all Y_f are smooth schemes. As smoothness is stable under base extension, it follows that also the product $\prod_{G, (Y_f)_f} X_v$ is a smooth scheme. Furthermore the morphisms $\prod_{G, (Y_f)_f} X_v \rightarrow Y_f$ which are induced by $e_f : X_v \rightarrow Y_f$, are also smooth for every leaf f of G .

If there is some scheme Y such that there is a morphism $\varphi_f : Y_f \rightarrow Y$ for every flag f , we can define the fibre product $\prod_{G, Y} X_v := \prod_{G, (Y_f)_f} X_v$ using the morphisms $\varphi_f \circ e_f$. The universal property of the usual fibre product yields $\prod_{G, (Y_f)_f} X_v \cong \prod_{G, Y} X_v$.

Definition 2.4.2 (Boundary strata). Let $\gamma = (G, (\Delta_v, \sigma_v)_{v \in V_\gamma})$ be a combinatorial type of tropical degree Δ curves in Σ . For a vertex v of γ let $\Sigma_v = \text{Star}_\Sigma(\sigma_v)$, F^v the flags of γ which are incident to v and let $\overline{\Delta}_v$ be the image of the local degree Δ_v in $\mathbb{R}^m/V_{\sigma_v}$. By iterated application of Property III in Section 7 of [BM96]

$$\prod_{G, X(\Sigma)} \overline{M}_{0, F^v}(X(\Sigma_v), \beta_{\overline{\Delta}_v}) \hookrightarrow \overline{M}_{0, n}(X(\Sigma), \beta_\Delta)$$

is a closed substack. Therefore $W_\gamma^\circ := \prod_{G, X(\Sigma)} W_{\overline{\Delta}_v, X(\Sigma_v)}^\circ \hookrightarrow \overline{M}_{0, n}(X(\Sigma), \beta_\Delta)$ is a locally closed substack and we can define

$$W_{\Delta, Y}^\circ(\gamma) := W_\gamma^\circ \times_{\overline{M}_{0, n}(X(\Sigma), \beta_\Delta)} W_{\Delta, Y}$$

which is a locally closed substack of $W_{\Delta, Y}$. According to Definition 2.2.19 $W_{\Delta, Y}^\circ(\gamma)$ is the substack of all stable maps of combinatorial type γ . We define the closure of $W_{\Delta, Y}^\circ(\gamma)$ in $W_{\Delta, Y}$ as $W_{\Delta, Y}(\gamma)$.

Lemma 2.4.3. *The boundary $\partial W_{\Delta, X(\Sigma)}$ is of pure codimension one.*

PROOF. The locus of reducible curves in $\partial W_{\Delta, X(\Sigma)}$ clearly is of pure codimension one, as it is the intersection (with reduced structure) of $W_{\Delta, X(\Sigma)}$ with the boundary divisors of $\overline{M}_{0, n}(X(\Sigma), \beta_\Delta)$. Assume there is a stable map $\mathcal{C} = (C, x_1, \dots, x_n, \pi)$ of combinatorial type γ having only one vertex, which is mapped into σ° for $\sigma \in \Sigma$ and let $\sigma(1) = \{\rho_1, \dots, \rho_r\}$. Then there are combinatorial types β_i , where $i = 1, \dots, r$, having only one vertex each, such that the vertex of β_i is mapped into ρ_i° for every i . We abbreviate $\Sigma_i := \text{Star}_\Sigma(\rho_i)$ and let Δ_i be the image of Δ in \mathbb{R}^m/V_{ρ_i} . By explicitly writing down families, we can see that $W_{\Delta_i, X(\Sigma_i)} \cong W_{\Delta, X(\Sigma)}(\beta_i) \hookrightarrow W_{\Delta, X(\Sigma)}$ and \mathcal{C} lies in every $W_{\Delta, X(\Sigma)}(\beta_i)$. In particular $\dim W_{\Delta, X(\Sigma)}(\beta_i) = \dim W_{\Delta_i, X(\Sigma_i)} = \dim X(\Sigma_i) - |\Delta| - 3 = \dim X(\Sigma) - 1 - |\Delta| - 3 = \dim W_{\Delta, X(\Sigma)} - 1$. \square

Later on, we will partially classify integral substacks of codimension one which are contained in the boundary. To do this, we will need the following two Lemmas.

Lemma 2.4.4. *If W is an irreducible closed substack of $\partial W_{\Delta, Y}$, then there is some combinatorial type γ of degree Δ curves in \mathcal{Y} such that $W \hookrightarrow W_{\Delta, Y}(\gamma)$.*

PROOF. Let W_γ° be as in the Definition 2.4.2 and let W_γ be its closure in the space of all curves, $\overline{M}_{0, n}(X(\Sigma), \beta_\Delta)$. By Theorem 2.2.18 $\partial W_{\Delta, Y}$ is a closed substack of $\bigcup_\gamma W_\gamma$, where the union runs over all non-trivial combinatorial types γ of degree Δ curves in \mathcal{Y} . As W is irreducible, it must be a closed substack of an irreducible component of some W_γ . Since $W_{\Delta, Y}(\gamma) = W_\gamma \cap W_{\Delta, Y}$, the claim follows. \square

Lemma 2.4.5. *If W is an irreducible component of $W_{\Delta, Y}(\gamma)$ with $W \hookrightarrow W_{\Delta, Y}(\beta)$, then $\gamma \geq \beta$.*

PROOF. Let $\beta = (G, (\Delta_v, \sigma_v)_{v \in V_G})$, let $\Sigma_v := \text{Star}_\Sigma(\sigma_v)$ and let $\overline{\Delta}_v$ be the image of Δ_v in $\mathbb{R}^m/V_{\sigma_v}$. Clearly $W^\circ := W \cap W_{\Delta, Y}^\circ(\gamma) \neq \emptyset$ and we have inclusions

$$W^\circ \hookrightarrow W_{\Delta, Y}(\beta) \hookrightarrow \prod_{G, X(\Sigma)} W_{\overline{\Delta}_v, X(\Sigma_v)}$$

Every stable map $\mathcal{C} = (C, x_1, \dots, x_n, \pi)$ in W° can be decomposed into unique *subcurves* $(C(v), F(v), \pi|_{C(v)})$ in $W_{\Delta, X(\Sigma_v)}$ for the vertices v of β . By a subcurve, we mean that $C(v)$ is a connected union of irreducible components of C . The marked points $F(v)$ on $C(v)$ are those x_j with $x_j \in C(v)$ and the intersections of $C(v)$ with those irreducible components of C which do not belong to $C(v)$. This decomposition works as in the proof of Lemma 12 of [FP97]. The stable map $(C(v), F(v), \pi|_{C(v)})$ corresponds to a resolution γ_v of the vertex v of β (modulo V_{σ_v}) by Theorem 2.2.18. As the whole curve \mathcal{C} is of combinatorial type γ , we conclude by Lemma 1.5.16 that $\gamma \geq \beta$. \square

It would be nice to know if the converse of the previous lemma holds, i.e. if $\gamma \geq \beta$ implies $W_{\Delta, Y}(\gamma) \leftrightarrow W_{\Delta, Y}(\beta)$. But this seems to be much more difficult, it might even be wrong.

Let us now consider an example which shows that the boundary of $W_{\Delta, Y}$ does in general not have a nice recursive structure, even for $Y = X(\Sigma)$. This example also shows a way to attack this problem, namely refining the fan Σ .

Example 2.4.6. Consider $\Sigma = L_2^2$, i.e. $X(\Sigma) = \mathbb{P}^2$, and the degree $\Delta = (2e_1, 2e_2, e_0, e_0)$. Denote the coordinate hyperplanes of \mathbb{P}^2 by L_0, L_1, L_2 . Lemma 2.3.1 tells us that $W_{\Delta, X(\Sigma)}$ is three dimensional. Consider the combinatorial type γ which occurs by moving the trivial combinatorial type into $-e_0$ direction. This generates two two-valent vertices over the origin. We see that the space of all curves corresponding to γ , i.e. W_γ° from Definition 2.4.2, is also of dimension three. One dimension for each line through $L_1 \cap L_2$ and one for the fourth special point on the contracted component C_0 over $L_1 \cap L_2$. This means, that not all such curves can occur in the boundary of $W_{\Delta, X(\Sigma)}$.

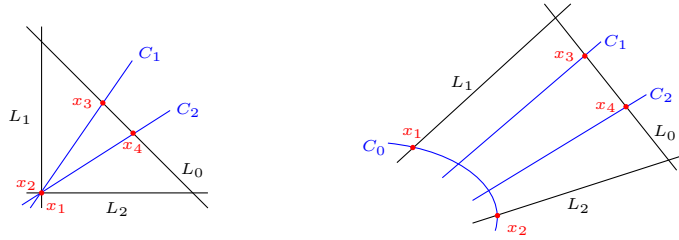

If we blow up \mathbb{P}^2 in $L_1 \cap L_2$ and consider curves of degree Δ in the fan where σ_{12} is subdivided, we obtain degree two covers from C_0 onto the exceptional divisor E , ramified at x_1 and x_2 over $E \cap L_1$ and $E \cap L_2$. The components C_1 and C_2 are still mapped as lines into \mathbb{P}^2 , but their intersection points with E also uniquely determine their intersections with L_0 . Therefore the conditions that the components C_0, C_1 and C_2 glue together already determines the stable map, the only parameters being the gluing points on C^0 . This generalises to Proposition 2.4.13.

Now we want to formulate the idea of refining the fan Σ more precisely.

Construction 2.4.7. Let $\tilde{\Sigma}$ and Σ be rational smooth projective fans in $\tilde{V} := \tilde{\Lambda} \otimes_{\mathbb{Z}} \mathbb{R}$ respectively $V := \Lambda \otimes_{\mathbb{Z}} \mathbb{R}$. Furthermore let $\varphi : \tilde{V} \rightarrow V$ be an integer linear map such that for every $\tilde{\sigma} \in \tilde{\Sigma}$ there is a $\sigma \in \Sigma$ with $\varphi(\tilde{\sigma}) \subset \sigma$. Then φ induces a toric morphism $\phi : X(\tilde{\Sigma}) \rightarrow X(\Sigma)$ as in [CLS11], § 3.3. Furthermore we also obtain a morphism $\Phi : \overline{M}_{0,n}(X(\tilde{\Sigma}), \beta) \rightarrow \overline{M}_{0,n}(X(\Sigma), \phi_*\beta)$ which maps a family $(\tilde{C}, \tilde{p}, S, \tilde{x}_1, \dots, \tilde{x}_n, \tilde{\pi})$ to its stabilisation $(C, p, S, x_1, \dots, x_n, \pi)$, cf. [BM96] Proposition 3.10. I.e. there is a stabilising morphism $\Phi_S : \tilde{C} \rightarrow C$ which is proper and surjective and satisfies $\phi \circ \tilde{\pi} = \pi \circ \Phi_S, \tilde{p} = \Phi_S \circ p$ and $x_j = \Phi_S \circ \tilde{x}_j$ for $1 \leq j \leq n$. Note that Φ is proper and separated, as it is a morphism between two separated stacks which are proper over $\text{Spec } \mathbb{C}$.

Furthermore, a combinatorial type γ of degree Δ tropical curves in $\tilde{\Sigma}$ defines a combinatorial type $\varphi(\gamma)$ of degree $\varphi\Delta$ tropical curves in Σ as follows. If $(\Gamma, x_1, \dots, x_n, h)$ is a tropical

curve of combinatorial type γ , then $(\Gamma, x_1, \dots, x_n, \varphi \circ h)$ is a tropical curve in Σ of some combinatorial type $\varphi(\gamma)$. This does not depend on the choice of the tropical curve, because $\tilde{\Sigma}$ and Σ are fans and φ is linear, mapping cones into cones.

Lemma 2.4.8. *The morphism of moduli spaces from above restricts to $\Phi : W_{\Delta, X(\tilde{\Sigma})} \longrightarrow W_{\varphi\Delta, X(\Sigma)}$ and it further restricts to $\Phi : W_{\Delta, X(\tilde{\Sigma})}(\gamma) \longrightarrow W_{\varphi\Delta, X(\Sigma)}(\varphi(\gamma))$.*

PROOF. As the coarse moduli spaces of $W_{\Delta, X(\tilde{\Sigma})}$ and $W_{\varphi\Delta, X(\Sigma)}$ are of finite type over \mathbb{C} , it suffices to check what Φ does on stable maps over $\text{Spec } \mathbb{C}$. Let $(C, x_1, \dots, x_n, \tilde{\pi})$ be a stable map in $W_{\Delta, X(\tilde{\Sigma})}^\circ$. By assumption C is smooth and rational. We obtain a stable map to $X(\Sigma)$ by just composing the morphisms $\phi \circ \tilde{\pi}$. If we denote $C' := C \setminus \{x_1, \dots, x_n\}$ then the restriction $\pi := \tilde{\pi}|_{C'} : C' \longrightarrow T^k$ maps into the dense torus of $X(\tilde{\Sigma})$ and the composition $\phi \circ \pi : C' \longrightarrow T^m$ maps into the dense torus of $X(\Sigma)$. As in Section 1 of [Spe07] the map

$$\tilde{\Lambda}^\vee \longrightarrow \mathbb{Z} \text{ with } \tilde{\lambda} \mapsto \text{ord}_{x_j} \pi^* \chi^{\tilde{\lambda}}$$

is linear and therefore defines a unique element $\delta_j \in \tilde{\Lambda}$ with $\langle \delta_j, \tilde{\lambda} \rangle = \text{ord}_{x_j} \pi^* \chi^{\tilde{\lambda}}$ for all $\tilde{\lambda} \in \tilde{\Lambda}^\vee$. In the same way,

$$\Lambda^\vee \longrightarrow \mathbb{Z} \text{ with } \lambda \mapsto \text{ord}_{x_j} \pi^* \phi^* \chi^\lambda$$

is linear, defining a unique $\delta'_j \in \Lambda$ with $\langle \delta'_j, \lambda \rangle = \text{ord}_{x_j} \pi^* \phi^* \chi^\lambda$ for all $\lambda \in \Lambda^\vee$. We obtain

$$\langle \delta'_j, \lambda \rangle = \text{ord}_{x_j} \pi^* \phi^* \chi^\lambda \stackrel{(a)}{=} \text{ord}_{x_j} \pi^* \chi^{\varphi^\vee(\lambda)} = \langle \delta_j, \varphi^\vee(\lambda) \rangle = \langle \varphi(\delta_j), \lambda \rangle$$

for all $\lambda \in \Lambda^\vee$ and hence $\varphi(\delta_j) = \delta'_j$. Here $\varphi^\vee : \Lambda^\vee \longrightarrow \tilde{\Lambda}^\vee$ denotes the dual map induced by $\varphi : \tilde{\Lambda} \longrightarrow \Lambda$ and the equality (a) holds by the construction of ϕ from φ .

Assume $\tau \leq \sigma$ are cones of $\tilde{\Sigma}$ such that σ is maximal and $\tilde{\pi}(x_j) \in O(\tau) \subset U_\sigma$. Then the u_ρ for $\rho \in \sigma(1)$ are a \mathbb{Z} -basis of $\tilde{\Lambda}$ and we can consider the dual basis λ_ρ . As $\text{div} \chi^{\lambda_\rho}$ restricted to U_σ is just D_ρ , we conclude that

$$\text{ord}_{x_j} \tilde{\pi}^* D_\rho = \text{ord}_{x_j} \psi^* \chi^{\lambda_\rho} = \langle \delta_j, \lambda_\rho \rangle \text{ for } \rho \in \sigma(1)$$

and $\Delta = (\delta_1, \dots, \delta_n)$. The same argument applied to the fan Σ shows that the stable map $(C, x_1, \dots, x_n, \phi \circ \tilde{\pi})$ is in $W_{\varphi\Delta, X(\Sigma)}^\circ$. In particular we also obtain $\phi_* \beta_\Delta = \beta_{\varphi\Delta}$ and taking closures yields $\Phi : W_{\Delta, X(\tilde{\Sigma})} \longrightarrow W_{\varphi\Delta, X(\Sigma)}$.

We will now prove the statement about the combinatorial types by applying the case of irreducible curves for each component. For a vertex v of γ let $\tilde{\sigma}_v$ denote the unique cone such that v gets mapped into $\tilde{\sigma}_v^\circ$ and let σ_v denote the inclusion minimal cone of Σ with $\varphi(\tilde{\sigma}_v) \subset \sigma_v$. Then the map φ induces an integer linear map $\varphi_v : \tilde{V}/\tilde{V}_{\tilde{\sigma}_v} \longrightarrow V/V_{\sigma_v}$. Furthermore, let $\overline{\Delta}_v$ be the image of the local degree in $\tilde{V}/\tilde{V}_{\tilde{\sigma}_v}$ for every vertex v of γ . If we denote $\tilde{\Sigma}_v = \text{Star}_{\tilde{\Sigma}}(\tilde{\sigma}_v)$ and $\Sigma_v = \text{Star}_\Sigma(\sigma_v)$, the map φ_v induces a toric morphism $\phi_v : X(\tilde{\Sigma}_v) \longrightarrow X(\Sigma_v)$ which equals the restriction of ϕ to $X(\tilde{\Sigma}_v)$ by construction, cf. [CLS11] Lemma 3.3.21. By what we showed above, ϕ_v induces a morphism between the stacks $\Phi_v : W_{\overline{\Delta}_v, X(\tilde{\Sigma}_v)}^\circ \longrightarrow W_{\varphi_v \overline{\Delta}_v, X(\Sigma_v)}$. As in Definition 2.4.2 we obtain closed immersions

$$\tilde{\iota} : W_\gamma^\circ := \prod_{G_\gamma, X(\tilde{\Sigma})} W_{\overline{\Delta}_v, X(\tilde{\Sigma}_v)}^\circ \hookrightarrow \overline{M}_{0,n}(X(\tilde{\Sigma}), \beta_\Delta) \text{ with image } M_\gamma^\circ$$

$$\text{and } \iota : W_{\varphi(\gamma)}^\circ := \prod_{G_{\varphi(\gamma)}, X(\Sigma)} W_{\varphi_v \overline{\Delta}_v, X(\Sigma_v)} \hookrightarrow \overline{M}_{0,n}(X(\Sigma), \beta_{\varphi\Delta}) \text{ with image } M_{\varphi(\gamma)}^\circ,$$

where G_γ and $G_{\varphi(\gamma)}$ denote the graphs of the combinatorial types. The vertices of $\varphi(\gamma)$ can be considered as a subset of the vertices of γ . For each vertex v of $\varphi(\gamma)$ we want to denote

the projection from W_γ° onto the factor $W_{\Delta_v, X(\tilde{\Sigma}_v)}$ by pr_v . We obtain that

$$\Phi' := \prod_{v \in V_\varphi(\gamma)} (\Phi_v \circ \text{pr}_v)$$

maps W_γ° to $W_{\varphi(\gamma)}^\circ$. As ϕ_v is the restriction of ϕ we have that $\Phi = \iota \circ \Phi' \circ \tilde{\iota}^{-1}$. Hence $\Phi : M_\gamma^\circ \rightarrow M_{\varphi(\gamma)}^\circ$ and together with $\Phi : W_{\Delta, X(\tilde{\Sigma})} \rightarrow W_{\Delta, X(\Sigma)}$ we obtain the claim about the combinatorial types. \square

For the rest of this section let $\tilde{\Sigma}$ be a smooth and projective refinement of the smooth and projective fan $\Sigma \subset \mathbb{R}^m$ and let $\varphi = \text{id}_{\mathbb{R}^m}$. In particular the induced toric morphism ϕ restricts to the identity on the dense open tori. In this case we can say a little bit more about Φ . We will denote $\beta_{\tilde{\Delta}} := [\Delta]^{M(\tilde{\Sigma})}$ and $\beta_\Delta := [\Delta]^{M(\Sigma)}$ (cf. (10)), where we consider Δ as a tropical fan in a canonical way. For the rest of this section we will abbreviate $W_\Delta = W_{\Delta, X(\Sigma)}$ and $W_{\tilde{\Delta}} = W_{\Delta, X(\tilde{\Sigma})}$.

Remark 2.4.9. In general there are several combinatorial types $\tilde{\gamma}$ of tropical curves of degree Δ in $\tilde{\Sigma}$ such that $\varphi(\tilde{\gamma}) = \gamma$, cf. the picture below. However, if γ is of geometric dimension one, a curve of this combinatorial type can be transformed into any other curve of this combinatorial type by rescaling Σ . Hence the set of all possible positions in \mathbb{R}^m of a vertex of γ is a ray (without the origin) and therefore there is a *unique* combinatorial type $\tilde{\gamma}$ with $\varphi(\tilde{\gamma}) = \gamma$. The picture below shows examples in L_2^2 of both cases, where the combinatorial type $\tilde{\gamma}$ is unique and where it is not.

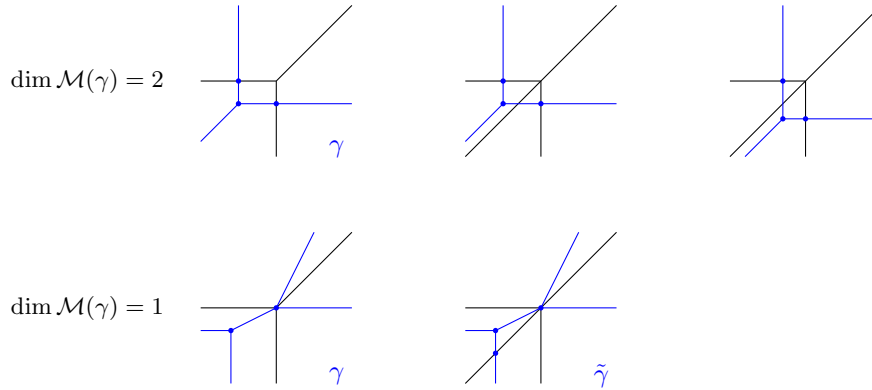

We will see in Proposition 2.4.13 that refining the fan Σ is indeed useful to understand the boundary a little more. Furthermore, we will see in Section 3.1 that intersections of the virtual fundamental class and the boundary can be used to determine a one dimensional tropical fan that is a candidate for the tropical moduli space we are looking for, cf. Conjecture 3.1.7. Therefore we will also study how the virtual fundamental class behaves under refinements of the fan. To do this, we first need to state two lemmas.

Lemma 2.4.10. *The morphism $\Phi : W_{\tilde{\Delta}} \rightarrow W_\Delta$ from above is surjective. Push forward along Φ yields $\Phi_* [W_{\tilde{\Delta}}] = [W_\Delta]$.*

PROOF. Let M_Δ denote the coarse moduli space of W_Δ and let $p_\Delta : W_\Delta \rightarrow M_\Delta$ be the canonical proper morphism. By Lemma 2.4.8 we have $p_\Delta \circ \Phi : W_{\tilde{\Delta}} \rightarrow M_\Delta$ and as this morphism has a scheme as target, it factors through the coarse moduli space $M_{\tilde{\Delta}}$ of $W_{\tilde{\Delta}}$ as $\Phi_M \circ p_{\tilde{\Delta}} = p_\Delta \circ \Phi$. Here $p_{\tilde{\Delta}} : W_{\tilde{\Delta}} \rightarrow M_{\tilde{\Delta}}$ is the canonical morphism. Clearly also Φ_M is proper as a morphism between separated projective schemes.

We will show that Φ_M is a bijection between the closed points of $p_{\tilde{\Delta}}(W_{\tilde{\Delta}}^\circ)$ and $p_\Delta(W_\Delta^\circ)$. Given a stable map $(C, x_1, \dots, x_n, \pi) \in W_\Delta^\circ$, we can consider $C' := C \setminus \{x_1, \dots, x_n\}$ and $\pi' := \pi|_{C'} : C' \rightarrow T^m$, where T^m is the dense torus of $X(\tilde{\Sigma})$ and $X(\Sigma)$. As the map ϕ restricts to

the identity on the dense open tori of $X(\tilde{\Sigma})$ and $X(\Sigma)$, we can extend $\pi' : C' \rightarrow X(\tilde{\Sigma})$ to $\tilde{\pi} : C \rightarrow X(\tilde{\Sigma})$ by the valuative criterion of properness and smoothness of C . Hence we obtain a stable map $(C, x_1, \dots, x_n, \tilde{\pi}) \in W_{\tilde{\Delta}}$. By construction we obviously have $\pi \circ \phi = \tilde{\pi}$. This proves the bijectivity.

Now $M_{\tilde{\Delta}}$ is the closure of $p_{\Delta}(W_{\tilde{\Delta}}^{\circ})$ and M_{Δ} is the closure of $p_{\Delta}(W_{\Delta}^{\circ})$ as the coarse moduli spaces are of finite type over \mathbb{C} . Properness of Φ_M yields surjectivity between the coarse moduli spaces.

This can now be used to show that the image of $W_{\tilde{\Delta}}$ under Φ is just W_{Δ} in the sense of Definition (1.7) in [Vis89]. By Proposition (2.6) of the same paper there is a proper surjective morphism q from a scheme $N_{\tilde{\Delta}}$ to $W_{\tilde{\Delta}}$. Let $f = \Phi_M \circ p_{\Delta} \circ q$ and $g = \Phi \circ q$ which are both proper as compositions of proper morphisms. From surjectivity of q and what we already know about Φ_M , we conclude that the image of f contains all closed points of $p_{\Delta}(W_{\tilde{\Delta}}^{\circ})$ and therefore it is surjective, as it is proper. Since W_{Δ} is a Deligne-Mumford stack and the source of g is a scheme, g is representable by [Vis89], Proposition 7.13. To show that g is also surjective, consider a morphism from a scheme $V \rightarrow W_{\Delta}$ which gives us the following commutative diagram.

$$\begin{array}{ccccc}
 & & f & & \\
 & & \curvearrowright & & \\
 N_{\tilde{\Delta}} & \xrightarrow{g} & W_{\tilde{\Delta}} & \xrightarrow{p_{\Delta}} & M_{\tilde{\Delta}} \\
 \uparrow & & \uparrow & \nearrow & \\
 N_{\tilde{\Delta}} \times_{W_{\Delta}} V & \longrightarrow & V & &
 \end{array}$$

This shows that $N_{\tilde{\Delta}} \times_{W_{\Delta}} V \cong N_{\tilde{\Delta}} \times_{M_{\tilde{\Delta}}} V$ and the induced morphism $N_{\tilde{\Delta}} \times_{W_{\Delta}} V \rightarrow V$ corresponds to a base change of f under this isomorphism and hence it is surjective, since f is. If we choose V as an atlas, then by the surjectivity of g the image of $W_{\tilde{\Delta}}$ under Φ (cf. Definition 1.7 of [Vis89]) is defined as the stack coming from the groupoid structure $R = V \times_{W_{\Delta}} V \rightrightarrows V$ which is just the stack W_{Δ} (cf. the end of section 7 in [Vis89]).

By Lemma 1.16 of [Vis89] we obtain the following equation for the degrees

$$\deg(W_{\tilde{\Delta}}/M_{\tilde{\Delta}}) \deg(M_{\tilde{\Delta}}/M_{\Delta}) = \deg(W_{\tilde{\Delta}}/W_{\Delta}) \deg(W_{\Delta}/M_{\Delta}).$$

As Φ_M is generically a bijection, we have $\deg(M_{\tilde{\Delta}}/M_{\Delta}) = 1$. By Corollary (2.5) of [Vis89] the degree of a stack over its moduli space is the number of automorphisms of a general element. Hence $\deg(W_{\tilde{\Delta}}/M_{\tilde{\Delta}}) = \deg(W_{\Delta}/M_{\Delta}) = 1$ and $\deg(W_{\tilde{\Delta}}/W_{\Delta}) = 1$. This proves the claim about the push forward. \square

Let $Y \subset X(\Sigma)$ be hypersurface such that $\mathcal{O}_{X(\Sigma)}(Y)$ is generated by global sections and such that there is a global section $y \in \Gamma(X(\Sigma), \mathcal{O}_{X(\Sigma)}(Y))$ with $Z(y) = Y$. Via the toric morphism $\phi : X(\tilde{\Sigma}) \rightarrow X(\Sigma)$ we also obtain a preimage hypersurface $\tilde{Y} = \phi^{-1}Y \subset X(\tilde{\Sigma})$. As in Construction 2.3.3 we obtain a vector bundle E_Y on W_{Δ} which we can pull back to $W_{\tilde{\Delta}}$ via Φ . The pull back $\phi^* \mathcal{O}_{X(\Sigma)}(Y) = \mathcal{O}_{X(\tilde{\Sigma})}(\tilde{Y})$ is also generated by global sections and the global section ϕ^*y clearly satisfies $Z(\phi^*y) = \tilde{Y}$, hence we also get a bundle $E_{\tilde{Y}}$ on $W_{\tilde{\Delta}}$. The next lemma shows how these bundles are related.

Lemma 2.4.11. *For the toric morphism $\phi : X(\tilde{\Sigma}) \rightarrow X(\Sigma)$, the hypersurface $\tilde{Y} = \phi^{-1}Y$ and the induced morphism $\Phi : W_{\tilde{\Delta}} \rightarrow W_{\Delta}$ we obtain*

$$\Phi^* E_Y \cong E_{\tilde{Y}}$$

for the vector bundles from Construction 2.3.3.

PROOF. We will prove the claim for the locally free sheaves $\mathcal{E}_{\tilde{Y}}$ and $\Phi^* \mathcal{E}_Y$. To compute the pull back of the locally free sheaf \mathcal{E}_Y on a family $(\tilde{C}, \tilde{f}^S, S, \tilde{x}_1, \dots, \tilde{x}_n, \tilde{\pi}_S)$, we need to compute

$$\begin{aligned} \Phi^* \mathcal{E}_Y(\tilde{C}, \tilde{f}^S, S, \tilde{x}_1, \dots, \tilde{x}_n, \tilde{\pi}_S) &= \mathcal{E}_Y(\Phi(\tilde{C}, \tilde{f}^S, S, \tilde{x}_1, \dots, \tilde{x}_n, \tilde{\pi}_S)) \\ &= \mathcal{E}_Y(C, f^S, S, x_1, \dots, x_n, \pi_S) = \Gamma(S, f_*^S \pi_S^* \mathcal{O}_{X(\Sigma)}(Y)), \end{aligned}$$

cf. [Sta] Section 61.7 "Sheaves of modules". Let $\Phi_S : \tilde{C} \rightarrow C$ be the S -morphism which stabilises the family, as in Construction 2.4.7. We then obtain a commutative diagram

$$\begin{array}{ccc} & \tilde{C} & \xrightarrow{\tilde{\pi}_S} X(\tilde{\Sigma}) \\ \tilde{f}^S \swarrow & \downarrow \Phi_S & \downarrow \phi \\ S & & \\ f^S \swarrow & C & \xrightarrow{\pi_S} X(\Sigma) \end{array}$$

By Construction 2.3.3 $\mathcal{E}_{\tilde{Y}}$ maps $(\tilde{C}, \tilde{f}^S, S, \tilde{x}_1, \dots, \tilde{x}_n, \tilde{\pi}_S)$ to $\Gamma(S, \tilde{f}_*^S \tilde{\pi}_S^* \mathcal{O}_{X(\tilde{\Sigma})}(\tilde{Y}))$. There is a canonical isomorphism

$$\tilde{f}_*^S \tilde{\pi}_S^* \mathcal{O}_{X(\tilde{\Sigma})}(\tilde{Y}) = f_*^S (\Phi_S)_* \tilde{\pi}_S^* \phi^* \mathcal{O}_{X(\Sigma)}(Y) \cong f_*^S (\Phi_S)_* \Phi_S^* \pi_S^* \mathcal{O}_{X(\Sigma)}(Y).$$

It is known that $(\Phi_S)_* \mathcal{O}_{\tilde{C}} = \mathcal{O}_C$ (cf. [BM96], proof of Proposition 3.10) so we may apply the projection formula ([Har97], II Exercise 5.1) to obtain another canonical isomorphism $(\Phi_S)_* \Phi_S^* \pi_S^* \mathcal{O}_{X(\Sigma)}(Y) \cong \pi_S^* \mathcal{O}_{X(\Sigma)}(Y)$. Altogether we get a canonical isomorphism

$$\tilde{f}_*^S \tilde{\pi}_S^* \mathcal{O}_{X(\tilde{\Sigma})}(\tilde{Y}) \cong f_*^S \pi_S^* \mathcal{O}_{X(\Sigma)}(Y).$$

One can check that these isomorphisms are compatible with the restriction maps of the sheaves, which is quite cumbersome to write down explicitly. The claim about the vector bundles follows immediately. \square

Obviously Φ also restricts to a morphism $\Phi : W_{\Delta, \tilde{Y}} \rightarrow W_{\Delta, Y}$ since $\phi(\tilde{Y}) = Y$. We can use the previous lemma to see what happens to the virtual fundamental class under push forward along this morphism.

Corollary 2.4.12. *With the notation from above we have*

$$\Phi_* [W_{\Delta, \tilde{Y}}]^{vir} = [W_{\Delta, Y}]^{vir} \in A_*(W_{\Delta, Y})_{\mathbb{Q}}.$$

PROOF. The usual properties of Gysin homomorphisms also hold for stacks, which was proven in [Kre99], Theorem 2.1.12 (xi). Therefore we may apply [Ful98], Proposition 14.1. (d) (ii). This yields

$$\Phi_* [W_{\Delta, \tilde{Y}}]^{vir} = \deg(W_{\tilde{\Delta}}/W_{\Delta}) [W_{\Delta, Y}]^{vir} \in A_*(W_{\Delta, Y})_{\mathbb{Q}}.$$

By Lemma 2.4.10 we know $\deg(W_{\tilde{\Delta}}/W_{\Delta}) = 1$. \square

The following proposition generalises the idea from Example 2.4.6. It shows that under certain assumptions on a combinatorial type γ , at least the boundary stratum $W_{\Delta}^{\circ}(\gamma)$ has a recursive structure. Unfortunately we cannot prove that this extends to the closure of the boundary stratum, cf. Conjecture 2.4.14. The reason for the usefulness of refinements of Σ is that we can always find a refinement such that γ satisfies the assumptions of the proposition, cf. Corollary 2.4.15 or Corollary 2.4.17.

Proposition 2.4.13. *Let $\gamma = (G, (\Delta_v, \sigma_v)_{v \in V_G})$ be a combinatorial type of degree Δ curves in Σ such that every vertex v of γ lies on a ray of Σ or the origin, i.e. $\sigma_v \in \Sigma(1)$ or $\sigma_v = 0$. Then*

$$W_\Delta^\circ(\gamma) \cong \prod_{G, X(\Sigma)} W_{\overline{\Delta}_v, X(\Sigma_v)}^\circ,$$

where $\Sigma_v = \text{Star}_\Sigma(\sigma_v)$ and $\overline{\Delta}_v$ is the image of Δ_v in $\mathbb{R}^m/V_{\sigma_v}$.

PROOF. As in Definition 2.4.2 we see that $\prod_{G, X(\Sigma)} W_{\overline{\Delta}_v, X(\Sigma_v)}^\circ \hookrightarrow \overline{M}_{0,n}(X(\Sigma), \beta_\Delta)$ is a locally closed substack. We want to denote the image in $\overline{M}_{0,n}(X(\Sigma), \beta_\Delta)$ by M_γ° . We now want to show that M_γ° is actually a locally closed substack of W_Δ . As the coarse moduli space of $\overline{M}_{0,n}(X(\Sigma), \beta_\Delta)$ is of finite type over \mathbb{C} , it suffices to check this for stable maps over $\text{Spec } \mathbb{C}$.

Let $\mathcal{C} = (C, x_1, \dots, x_n, \pi) \in M_\gamma^\circ$. We will prove the claim by just writing down a family in W_Δ° over $D = \text{Spec } \mathbb{C}[[t]]$ with \mathcal{C} as special fibre. We will find the family by reversing Constructions 2.2.20 and 2.2.21, so we will stick to the notation from there. Choose a tropical curve $(\Gamma, x_1, \dots, x_n, h)$ of combinatorial type γ such that for each vertex v of γ the image $h(v)$ lies in \mathbb{Z}^m and every edge of γ has integral length. Now insert additional two-valent vertices on all edges of Γ until each edge is of length 1. We denote the resulting underlying graph structure on Γ by G . In Construction 2.2.20, we called these additional two-valent vertices S -vertices. For an example picture we refer to Example 2.2.22.

Fix any vertex w of G . For every vertex v , let ρ_v denote the cell with $h(v) \in \rho_v^\circ$, which is either 0 or a ray of Σ . Now we want to label the vertices of G as in Construction 2.2.20. Let $k \in [n]$ and $V(0, k) := w$ for all k . For each k there is a unique path from w to the leaf x_k in G and we denote the vertices on this path by $V(0, k), V(1, k), \dots, V(m_k, k)$ in their order of appearance. Recall that we called the first number in the brackets the level of the vertex. Let $I(m, k) \subset [n]$ the set of all i such that $V(m, i) = V(m, k)$.

Now we want to choose coordinates on the irreducible components of C . For $C^{V(0, k)}$ we choose coordinates such that no special point is ∞ . For every other component $C^{V(m, k)}$, there is a node which is the intersection with a component $C^{V(m', k)}$ of lower level $m' < m$. We choose coordinates such that this node is ∞ . Choose numbers $\gamma_m^j \in \mathbb{C}$ as follows: For each $j \in [n]$ and $1 \leq m \leq m_j$ such that $V(m, j)$ is not an S -vertex, i.e. $C^{V(m, j)}$ is a component of C , let $(1 : s_j)$ denote the unique special point on the component $C^{V(m, j)}$, which is either the marked point x_j or the node which connects this component to the part of C containing x_j . We define $\gamma_m^j = s_j$ in this case. If $V(m, j)$ is an S -vertex, we choose $\gamma_m^k = 0$ for all $k \in I(m, j)$. We can now define

$$\tilde{x}_j = \sum_{m=0}^{m_j} \gamma_m^j t^m.$$

If we denote the set of special points on C^v by F^v for every vertex v of γ , the morphism $\pi|_{C^v}$ is given by a tuple of polynomials

$$\left(\beta_\rho^v z_0^{\alpha_\rho^\infty(v)} \prod_{f \in F^v \setminus \infty} (z_0 s_f - z_1)^{\alpha_\rho^f(v)} \right)_\rho$$

where the special points are ∞ and $(1 : s_f)$ for $f \in F^v \setminus \infty$. Of course, for $v = w$ we do not have the special point ∞ and hence $\alpha_\rho^\infty(w) = 0$ for all ρ .

We want to define elements $\tilde{\beta}_\rho \in \mathbb{C}[[t]]$ as follows: By assumption the vertex w has integral coordinates $h(w) = \sum_\rho v_\rho u_\rho$ where $(v_\rho)_\rho \in \mathbb{Z}_{\geq 0}^{\Sigma(1)}$ and $v_\rho > 0$ if and only if $\rho = \rho_w \in \Sigma(1)$. We now define $\tilde{\beta}_\rho = \beta_\rho^w t^{v_\rho}$ and $\tilde{\beta}_{\rho_w} = t^{v_{\rho_w}}$ in case $\rho_w \in \Sigma(1)$.

Let $\tilde{\pi} : \mathbb{P}_{D^*}^1 \rightarrow X(\Sigma)$ be given by the tuple $\left(\tilde{\beta}_\rho \prod_j (z_0 \tilde{x}_j - z_1)^{\alpha_\rho^j}\right)_\rho$ and define sections $\tilde{x}_j := (1 : \tilde{x}_j) : D^* \rightarrow \mathbb{P}_{D^*}^1$. As usual we have $D^* = \text{Spec } \mathbb{C}[[t]]_t$.

Comparing our choices \tilde{x}_j and $\tilde{\beta}_\rho$ to Constructions 2.2.20 and 2.2.21 we see that the family $(\mathbb{P}_{D^*}^1, \text{pr}, D^*, \tilde{x}_1, \dots, \tilde{x}_n, \tilde{\pi})$ extends to a family over D having a special fibre $(C', x'_1, \dots, x'_n, \pi')$ with $C \cong C'$ and x_j corresponds to x'_j via this isomorphism. Hence we will identify the curves and the points. After this identification we also obtain $\pi|_{C^v(0, k)} = \pi'|_{C^v(0, k)}$, cf. (47).

We will now prove by induction on the level that π and π' also coincide on the other irreducible components, after possibly adjusting our choices for \tilde{x}_j . Let $k \in [n]$, $m < m' \leq m_k$, $v := V(m, k)$ and $v' := V(m', k)$ such that $C^{v'}$ intersects C^v in a node. For this note that $\pi'|_{C^v}(1 : s_k)$ only depends on level m and below, i.e. γ_l^j with $l \leq m$, and also on $(\tilde{\beta}_\rho)_\rho$, cf. (47).

1st case: $\rho_v = \rho_{v'} = 0$. We obtain

$$\pi|_{C^{v'}}(\infty) = \left(\beta_\rho^{v'} \prod (-1)^{\alpha_\rho^f(v')}\right)_\rho = \pi|_{C^v}(1 : s_k).$$

This uniquely determines the coefficients $\beta_\rho^{v'}$ for all $\rho \in \Sigma(1)$ up to action of the torus G_Σ from (26). As we already know that the special points coincide, only the coefficients $(\beta_\rho^{v'})_\rho$ are missing to recover $\pi|_{C^{v'}}$. But as we just saw, these coefficients are already determined by $\pi|_{C^v} = \pi'|_{C^v}$ and therefore $\pi|_{C^{v'}} = \pi'|_{C^{v'}}$.

2nd case: $\rho_v = 0, \rho_{v'} \in \Sigma(1)$. We obtain

$$(\pi|_{C^{v'}}(\infty))_\rho = \begin{cases} \beta_\rho^{v'} \prod (-1)^{\alpha_\rho^f(v')} & \text{if } \rho \neq \rho_v \\ 0 & \text{else} \end{cases}$$

where the index ρ stands for the ρ -coordinate of the point. As $\pi|_{C^{v'}}(\infty) = \pi|_{C^v}(1 : s_k)$ this again determines the coefficients $\beta_\rho^{v'}$ for all $\rho \neq \rho_v$ up to the G_Σ -action, hence $\pi|_{C^{v'}} = \pi'|_{C^{v'}}$.

3rd case: $\rho_v \in \Sigma(1), \rho_{v'} = 0$. We obtain

$$(\pi|_{C^{v'}}(\infty))_\rho = \begin{cases} \beta_\rho^{v'} \prod (-1)^{\alpha_\rho^f(v')} & \text{if } \rho \neq \rho_v \\ 0 & \text{else} \end{cases}.$$

$\pi|_{C^{v'}}(\infty) = \pi|_{C^v}(1 : s_k)$ determines the coefficients $\beta_\rho^{v'}$ for all $\rho \neq \rho_v$ up to the G_Σ -action. But we still need to find out about $\beta_{\rho_v}^{v'}$.

We can achieve arbitrary values of $\beta_{\rho_v}^{v'}$ on our limit component $C^{v'}$ by performing a coordinate change on $C^{v'} : (z_0 : z_1) \leftrightarrow (\tilde{z}_0 : \tilde{z}_1)$ where $\tilde{z}_0 = \eta z_0$ and $\tilde{z}_1 = z_1$. In our new coordinates the special points take the form $(1 : \tilde{s}_f)$ and ∞ , where $\tilde{s}_f = \eta^{-1} s_f$. This changes the ρ_v -coordinate of the map $\pi|_{C^{v'}}$ from

$$\beta_{\rho_v}^{v'} z_0^{\alpha_{\rho_v}^\infty(v')} \prod_{f \in F^{v'} \setminus \infty} (s_f z_0 - z_1)^{\alpha_{\rho_v}^j(v')}$$

to

$$(\eta^{-\alpha_{\rho_v}^\infty(v')} \beta_{\rho_v}^{v'}) \tilde{z}_0^{\alpha_{\rho_v}^\infty(v')} \prod_{f \in F^{v'} \setminus \infty} (\tilde{s}_f \tilde{z}_0 - \tilde{z}_1)^{\alpha_{\rho_v}^j(v')}$$

while the coefficients of all other entries stay the same, as the factor z_0 only occurs in the ρ_v -coordinate. Replacing the values $\gamma_{m'}^j$ by $\tilde{\gamma}_{m'}^j$ in \tilde{x}_j we obtain the same curve C' and marked points x'_j in the special fibre and additionally $\pi|_{C^{v'}} = \pi'|_{C^{v'}}$ for a suitable choice of η . Note that choosing η has neither influence on anything below level m' nor on other branches of the tree G .

4th case: $\rho_v, \rho_{v'} \in \Sigma(1)$. We obtain

$$(\pi|_{C^{v'}}(\infty))_\rho = \begin{cases} \beta_\rho^{v'} \prod (-1)^{\alpha_\rho^f(v')} & \text{if } \rho \neq \rho_v, \rho_{v'} \\ 0 & \text{else} \end{cases}.$$

Again, $\pi|_{C^{v'}}(\infty) = \pi|_{C^v}(1 : s_k)$ determines the coefficients $\beta_\rho^{v'}$ for all $\rho \neq \rho_v$ up to the G_Σ -action. As in the third case we obtain $\pi|_{C^{v'}} = \pi'|_{C^{v'}}$.

So we see that for any choice of \mathcal{C} we can find a family in W_Δ° with \mathcal{C} as special fibre, which proves the claim. \square

Conjecture 2.4.14. Let $\gamma = (G, (\Delta_v, \sigma_v)_{v \in V_G})$ be a combinatorial type of degree Δ curves in Σ such that every vertex v of γ lies on a ray of Σ or the origin. As this was the case in all examples that I saw, I suppose that the previous proposition can be generalised to

$$W_\Delta(\gamma) \cong \prod_{G, X(\Sigma)} W_{\bar{\Delta}_v, X(\Sigma_v)},$$

where $\Sigma_v = \text{Star}_\Sigma(\sigma_v)$ and $\bar{\Delta}_v$ is the image of Δ_v in $\mathbb{R}^m/V_{\sigma_v}$. We already saw in Example 2.4.6 that this is in general false if we omit the assumption that the vertices lie on rays or in the origin.

Corollary 2.4.15. *If γ is a combinatorial type of degree Δ curves in Σ , then $W_\Delta^\circ(\gamma) \neq \emptyset$.*

PROOF. Let $\tilde{\Sigma}$ be a smooth projective refinement of Σ such that there exists a combinatorial type $\tilde{\gamma}$ of degree Δ curves in $\tilde{\Sigma}$ that satisfies the assumptions of Proposition 2.4.13 and $\varphi(\tilde{\gamma}) = \gamma$. Then $W_\Delta^\circ(\tilde{\gamma}) \neq \emptyset$ by Proposition 2.4.13 and Lemma 2.4.8 yields the claim. \square

Proposition 2.4.16. *Let γ be a combinatorial type of degree Δ curves in Σ such that every vertex either lies in the origin or on a ray. Then $W_\Delta(\gamma)$ is irreducible.*

PROOF. Let $\gamma = (G_\gamma, (\Delta_v, \sigma_v)_{v \in V_{G_\gamma}})$, $\Sigma_v = \text{Star}_\Sigma(\sigma_v)$ and let $\bar{\Delta}_v$ be the image of Δ_v in $\mathbb{R}^m/V_{\sigma_v}$. To shorten notation let $U_v := W_{\bar{\Delta}_v, X(\Sigma_v)}^\circ$. By the Proposition 2.4.13 we already know that $W_\Delta^\circ(\gamma) \cong \prod_{G_\gamma, X(\Sigma)} U_v$. We now want to prove the irreducibility for $W_\Delta^\circ(\gamma)$. For simplicity assume first that all vertices of γ are at least three-valent. Then all U_v are smooth and irreducible schemes of finite type over \mathbb{C} by Lemma 2.3.1. As the schemes we work with are of finite type over \mathbb{C} , it suffices to consider their sets of closed points. Let $G = (V_G, F_G, j_G, \partial_G)$ be a connected subgraph of G_γ , where subgraph means $V_G \subset V_{G_\gamma}$, $F_G \subset F_{G_\gamma}$ and the map ∂_G is just a restriction of ∂_{G_γ} while $j_G(f) := j_{G_\gamma}(f)$ if $j_{G_\gamma}(f) \in F_G$ and $j_G(f) := f$ else. We will proceed by induction on the number of vertices of G .

The induction hypothesis is that for every leaf f of G which is incident to some vertex $w \in V_G$ the morphism $e_f : \prod_{G, X(\Sigma)} U_v \rightarrow X(\Sigma)$, which is induced by $\text{ev}_f : U_w \rightarrow X(\Sigma)$, has irreducible fibres.

First let us check the induction start. Let f be a flag with $\partial_G(f) = v$ such that it is mapped into σ° for some $\sigma \in \Sigma$. We will show that a fibre of the evaluation $\text{ev}_f : U_v \rightarrow O(\sigma)$ at the flag f is isomorphic to $T^{\dim \sigma - \dim \sigma_v} \times M_{0, \text{val}(v)}$, hence irreducible. As in Lemma 2.3.1 we can choose a maximal cone $\tau \in \Sigma(m)$ with $\tau \geq \sigma$ such that the torus factor of $U_v \cong T^{\dim \Sigma_v} \times M_{0, \text{val}(v)}$ has the coordinate functions $(\beta_\rho)_{\rho \in \tau(1) \setminus \sigma_v(1)}$. We have to take $\tau(1) \setminus \sigma_v(1)$ because we work with the fan Σ_v here. Choose coordinates on the universal family $\mathbb{P}_{U_v}^1$ such that the section f is constant ∞ . Then the evaluation ev_f on U_v is given by the tuple $(\beta_\rho (-1)^{m_\rho})_{\rho \in \tau(1) \setminus \sigma(1)}$ for suitable integers m_ρ . So keeping the image point fixed, we can vary the marked points freely and also those β_ρ with $\rho \in \sigma(1) \setminus \sigma_v(1)$. This proves the claim about the fibres. Note that $\text{ev}_f : U_v \rightarrow O(\sigma)$ is even smooth by generic smoothness (cf. III, Corollary 10.7 of [Har97]) and the action of the dense torus of $X(\Sigma)$ on $O(\sigma)$ and U_v , which is transitive on $O(\sigma)$.

For every connected subgraph G of G_γ as above let σ_f denote the cone into whose relative interior the flag f is mapped. We just saw that the evaluations $\text{ev}_f : U_{\partial_G(f)} \rightarrow O(\sigma_f)$ and the $O(\sigma_f)$ are smooth, hence also the fibre product $\prod_{G, (O(\sigma_f))_f} U_v \cong \prod_{G, X(\Sigma)} U_v$ is smooth. Furthermore also the morphisms $e_f : \prod_{G, X(\Sigma)} U_v \rightarrow O(\sigma_f)$ induced by the evaluation morphism $\text{ev}_f : U_{\partial_G(f)} \rightarrow O(\sigma_f)$ are smooth, cf. the remark in Definition 2.4.1. The reason is that smoothness is preserved under base extensions.

Now we want to prove the induction step, so let G be a connected subgraph of G_γ , w a vertex of G and f a leaf of G which is incident to w . As in Definition 2.4.1 let $E = \{\{f'_i, f_i\} \mid i = 1, \dots, r\}$ be the set of all edges of G that are adjacent to w , where $\partial_G(f_i) = w$ and $\partial_G(f'_i) = w_i$ for $i = 1, \dots, r$. Let G_1, \dots, G_r be those graphs which are obtained by cutting G at the edges E , except the graph that only has the vertex w . We assume that w_i is a vertex of G_i and we abbreviate $\sigma_i := \sigma_{f_i} = \sigma_{f'_i}$. Then the smooth evaluation morphism $\text{ev}_{f'_i} : U_{w_i} \rightarrow O(\sigma_i)$ induces a smooth morphism $e_i : \prod_{G_i, X(\Sigma)} U_v \rightarrow O(\sigma_i)$ for $i = 1, \dots, r$, as mentioned above.

For a point $t \in X(\Sigma)$ we obtain the fibre of e_f as

$$e_f^{-1}(t) = \bigcup_{x \in \text{ev}_f^{-1}(t)} \left(\prod_{i=1}^r e_i^{-1}(\text{ev}_{f'_i}(x)) \right) = \bigcup_{y \in \text{ev}(\text{ev}_f^{-1}(t))} e^{-1}(y).$$

Here $e := \prod_{i=1}^r e_i : \prod_{i=1}^r \prod_{G_i, X(\Sigma)} U_v \rightarrow \prod_{i=1}^r O(\sigma_i)$ is a smooth morphism, as it is a product of smooth morphisms, and $\text{ev} := \prod_{i=1}^r \text{ev}_{f'_i} : U_w \rightarrow \prod_{i=1}^r O(\sigma_i)$. By induction hypothesis the $e_i^{-1}(\text{ev}_{f'_i}(x))$ and hence the $e^{-1}(y)$ are irreducible and by the induction start also $\text{ev}_f^{-1}(t)$ and $\text{ev}(\text{ev}_f^{-1}(t))$ are irreducible. This implies that $e_f^{-1}(t)$ is irreducible, as e is smooth and thus also open.

So for G_γ and a marked point x_j we have that $e_{x_j} : \prod_{G_\gamma, X(\Sigma)} U_v \rightarrow O(\sigma_{x_j})$ is smooth, hence open. By induction the fibres of e_{x_j} are irreducible and irreducibility of $O(\sigma_{x_j})$ implies irreducibility of $\prod_{G_\gamma, X(\Sigma)} U_v$.

For the general case, where γ might have two-valent vertices, we add additional leaves of direction 0 to those vertices of γ of valence two. This gives a combinatorial type γ' of curves of degree Δ' . As above we see that $W_{\Delta'}^\circ(\gamma')$ is irreducible and as $W_\Delta^\circ(\gamma)$ clearly is the image of $W_{\Delta'}^\circ(\gamma')$ under forgetting the additional marked points, it is also irreducible. \square

Now we can use the results from above to partially classify integral substacks of codimension one that are contained in the boundary.

Corollary 2.4.17. *Let γ be a combinatorial type of degree Δ curves in Σ of geometric dimension one. Then $W_\Delta(\gamma)$ is irreducible and of codimension one in W_Δ .*

PROOF. First we choose a smooth projective refinement $\tilde{\Sigma}$ of Σ such that the unique combinatorial type $\tilde{\gamma}$ in $\tilde{\Sigma}$ with $\varphi(\tilde{\gamma}) = \gamma$ satisfies the conditions of Proposition 2.4.16. The combinatorial type $\tilde{\gamma}$ is unique, since γ is of geometric dimension one, cf. Remark 2.4.9. By Lemma 2.4.10 we know that Φ from Construction 2.4.7 is surjective and by Lemma 2.4.8 we know that $W_\Delta^\circ(\gamma)$ must be equal to $\Phi(W_{\tilde{\Delta}}^\circ(\tilde{\gamma}))$. Hence $\Phi(W_{\tilde{\Delta}}(\tilde{\gamma})) = W_\Delta(\gamma)$ is irreducible by Proposition 2.4.16.

Now we want to prove the claim about the codimension. Clearly $W_\Delta(\gamma)$ is contained in an irreducible component W of the boundary ∂W_Δ which is of codimension one. But then $W \hookrightarrow W_\Delta(\beta)$ for some combinatorial type β by Lemma 2.4.4. Then $\gamma \geq \beta$ by Lemma 2.4.5 and as β is non-trivial it must also be of geometric dimension one, thus $\beta = \gamma$. So we conclude $W_\Delta(\gamma) \hookrightarrow W \hookrightarrow W_\Delta(\beta) = W_\Delta(\gamma)$, which proves the claim. \square

Conjecture 2.4.18. As this is the case in all examples that I know, I suppose that also the converse of the previous corollary holds. I.e. for every integral substack W of ∂W_Δ of codimension one in W_Δ , there is some combinatorial type γ of geometric dimension one such that $W = W_\Delta(\gamma)$.

In the next chapter, we will be interested in explicitly determining the multiplicities of certain Cartier divisors along boundary divisors of the form $W_\Delta(\gamma)$. Unfortunately our methods are limited to computations on families over a smooth irreducible curve. Therefore we will find such a curve through $W_\Delta(\gamma)$ and compute the multiplicity on the curve. However, if W_Δ is étale locally around $W_\Delta(\gamma)$ the intersection of several irreducible components, this method yields the wrong multiplicity. Therefore we will prove Lemmas 2.4.20 and 2.4.21 about two cases where this approach works.

A scheme S is called *unibranch* around a point $P \in S$, if P has only one preimage under the normalisation map. This is the case if S is étale locally irreducible around P by the next lemma. In general we cannot expect W_Δ to be unibranch around an element of $W_\Delta^\circ(\gamma)$, cf. [Vak00], but there are two cases where we can say something. These cases are where γ is of geometric dimension one and consists of up to two vertices. In the following three lemmas let M_Δ denote the coarse moduli space of W_Δ and let $p : W_\Delta \rightarrow M_\Delta$ denote the canonical proper morphism. Furthermore let $M_\gamma^\circ := p(W_\Delta^\circ(\gamma))$.

Lemma 2.4.19. *Let R be a noetherian local domain which is complete with respect to its maximal ideal \mathfrak{m} . Then the integral closure R^ν in the field of fractions $Q(R)$ is a local integral domain, complete with respect to its maximal ideal.*

PROOF. It follows from Exercise 8 in Chapter V, §2 of [Bou72] that R^ν is a local integral domain. The ring R^ν is a finitely generated R -module, hence we obtain the \mathfrak{m} -adic completion of R^ν as $\widehat{R}^\nu = R^\nu \otimes_R \widehat{R} = R^\nu \otimes_R R = R^\nu$. The \mathfrak{m} -adic topology on R^ν is generated by $\mathfrak{m}^n R^\nu = (\mathfrak{m} R^\nu)^n$, the powers of the maximal ideal of R^ν . Hence R^ν is also complete with respect to its maximal ideal. \square

Lemma 2.4.20. *Let $|\Delta| \geq 3$ and let γ be a combinatorial type of degree Δ curves in Σ with only one vertex. Then the coarse moduli space M_Δ is smooth at every closed point of M_γ° , i.e. each irreducible boundary curve.*

PROOF. Let $\mathcal{C} = (C, x_1, \dots, x_n, \pi) \in W_\Delta^\circ(\gamma)$. We will show that the coarse moduli space M_Δ is smooth at \mathcal{C} . As $|\Delta| \geq 3$ the curve C has no automorphisms and we can compute the tangent space of M_Δ to \mathcal{C} as the space of first order deformations of \mathcal{C} . As $C \cong \mathbb{P}^1$ is rigid ([Har10], Example 5.3.1), first order deformations of C are all trivial. If π is given by $(\beta_\rho \prod_j (z_0 x_j - z_1)^{\alpha_\rho^j})_\rho$, then any first order deformation is given by the tuple

$$\left((\beta_\rho + \beta'_\rho \varepsilon) \prod_j (z_0(x_j + x'_j \varepsilon) - z_1)^{\alpha_\rho^j} \right)_\rho,$$

defining a morphism $\tilde{\pi} : \mathbb{P}_{\mathbb{C}[\varepsilon]/\langle \varepsilon^2 \rangle}^1 \rightarrow X(\Sigma)$. So we have $|\Sigma(1)| + |\Delta|$ parameters $\beta'_\rho, x'_j \in \mathbb{C}$. Let $\sigma \in \Sigma(m)$ be a maximal cone, such that $\beta_\rho = 0$ implies $\rho \in \sigma(1)$. Then we can assume $\beta_\rho + \beta'_\rho \varepsilon = 1$ for $\rho \notin \sigma(1)$ by Remark 2.1.6. Dividing by automorphisms of $\mathbb{P}_{\mathbb{C}[\varepsilon]/\langle \varepsilon^2 \rangle}^1$, we obtain a tangent space of dimension $\dim X(\Sigma) + |\Delta| - 3 = \dim W_\Delta$, which proves the claim. \square

Lemma 2.4.21. *Let $|\Delta| \geq 3$ and let γ be a combinatorial type of degree Δ curves in \mathcal{Y} which is of geometric dimension one and has two vertices. Then the coarse moduli space M_Δ is unibranch around every closed point of M_γ° .*

PROOF. Choose a closed point $\mathcal{C} \in M_\gamma^\circ$, i.e. a curve \mathcal{C} over \mathbb{C} , and an affine neighbourhood $U = \text{Spec } R$ of \mathcal{C} in M_Δ . Then we can consider the completion \widehat{R} with respect to the maximal ideal $\mathfrak{m}_\mathcal{C}$ defining the point \mathcal{C} . Let $M_\Delta^\circ := p(W_\Delta^\circ)$, which is a fine moduli space as $|\Delta| \geq 3$. We obtain a morphism $\widehat{e} : \widehat{U} := \text{Spec } \widehat{R} \rightarrow U$. Consider irreducible curves C_1 and C_2 inside \widehat{U} through $\widehat{\mathfrak{m}}_\mathcal{C} = \mathfrak{m}_\mathcal{C} \widehat{R}$, but $\widehat{e}(C_i) \not\subset M_\gamma^\circ$ for $i = 1, 2$. The idea is to show that C_1 and C_2 have to lie in the same irreducible component of \widehat{U} . To do this, we will find families of stable maps over C_1 and C_2 and then construct an irreducible two dimensional family of stable maps which contains both of them. Using Lemma 2.4.19 and the Cohen Structure Theorem, cf. [Eis04] Theorem 7.7, we see that the normalisations are $\nu_i : D = \text{Spec } \mathbb{C}[[t]] \rightarrow C_i$. Restricting to $D^* = \text{Spec } \mathbb{C}[[t]]_t$ we obtain morphisms $\widehat{e} \circ \nu_i : D^* \rightarrow M_\Delta^\circ$ and as M_Δ° is a fine moduli space, we also obtain families $\mathcal{F}_1 = (\mathcal{C}_1, p_1, D, x_1, \dots, x_n, \pi)$ and $\mathcal{F}_2 = (\mathcal{C}_2, p_2, D, \tilde{x}_1, \dots, \tilde{x}_n, \tilde{\pi})$ associated to these morphisms. Pick three sections, without loss of generality x_1, x_2, x_3 and $\tilde{x}_1, \tilde{x}_2, \tilde{x}_3$ and reparameterise the families such that these three sections attain fixed constant values in \mathbb{C} in the generic fibres. This has the consequence that if we want to compute the tropicalisations of the reparameterised families as in Construction 2.2.20, the vertex $V(0, k)$ is in both cases the unique vertex from which there are disjoint paths to the leaves x_1, x_2 and x_3 .

Because γ is of geometric dimension one, the ray $\mathcal{M}(\gamma)$ in $\mathcal{M}_0(\mathbb{R}^m, \Delta)$ has a primitive integer generator r_γ . Then the tropicalisation of the restriction of \mathcal{F}_1 to D^* (cf. Construction 2.2.20) equals $b_2 r_\gamma$ for some integer b_2 . Also the tropicalisation of the restriction of \mathcal{F}_2 to D^* equals $b_1 r_\gamma$ for an integer b_1 . Consider the finite base changes $\varphi_{b_i} : D \rightarrow D, t \mapsto t^{b_i}$ for $i = 1, 2$. Denote $\varphi_{b_1}^* \mathcal{F}_1 = (\mathcal{C}_1^*, p_1, D^*, x_1, \dots, x_n, \pi)$ and $\varphi_{b_2}^* \mathcal{F}_2 = (\mathcal{C}_2^*, p_2, D^*, \tilde{x}_1, \dots, \tilde{x}_n, \tilde{\pi})$ by abuse of notation. Clearly we have $\text{trop}(\pi, x_1, \dots, x_n) = \text{trop}(\tilde{\pi}, \tilde{x}_1, \dots, \tilde{x}_n) = b_1 b_2 r_\gamma$. Furthermore both families extend to families over D , having special fibre \mathcal{C} . Therefore the morphisms $\widehat{e} \circ \nu_i \circ \varphi_{b_i} : D^* \rightarrow M_\Delta^\circ$ extend to $\psi_i : D \rightarrow M_\Delta$. We can assume that $\text{trop}(\pi, x_1, \dots, x_n) = \text{trop}(\tilde{\pi}, \tilde{x}_1, \dots, \tilde{x}_n)$ has the vertices $V(0, k), \dots, V(m, k)$, where the vertices $V(1, k), \dots, V(m-1, k)$ are S -vertices and we abbreviate $v = V(0, k)$ and $w = V(m, k)$. As usual, let σ_v and σ_w denote the unique cones into whose relative interiors v and w are mapped. As v and w are adjacent in γ , σ_v and σ_w span a cone $\tau \in \Sigma$, i.e. $\tau(1) = \sigma_v(1) \cup \sigma_w(1)$. Assume that $\rho \in \sigma_v(1) \cap \sigma_w(1)$. Then we can vary the length of the unique edge of γ and move the curves of combinatorial type γ into direction u_ρ . Hence the geometric dimension of γ would be at least two. As γ is of geometric dimension one, we have that $\sigma_v(1) \cap \sigma_w(1) = \emptyset$. In the following let $\sigma \in \Sigma$ be a maximal cone with $\tau \leq \sigma$. By Lemma 2.2.17 we can assume that the morphisms π and $\tilde{\pi}$ are given by

$$\left(\beta_\rho \prod_j (z_0 x_j - z_1)^{\alpha_\rho^j} \right)_\rho \quad \text{and} \quad \left(\tilde{\beta}_\rho \prod_j (z_0 \tilde{x}_j - z_1)^{\alpha_\rho^j} \right)_\rho$$

with sections $x_j = \sum_m \gamma_m^j t^m$ and $\tilde{x}_j = \sum_m \tilde{\gamma}_m^j t^m$ and $\beta_\rho = \tilde{\beta}_\rho = 1$ for $\rho \notin \sigma(1)$, by Remark 2.1.6. From Construction 2.2.21 we know that $\gamma_0^j = \tilde{\gamma}_0^j$, because we fixed coordinates on $C^{(0, k)}$ by reparameterising the families \mathcal{F}_1 and \mathcal{F}_2 . Also the position of v in \mathbb{R}^m in the tropical curve represented by $b_1 b_2 r_\gamma$ is given by $(v(\beta_\rho))_\rho$ and $(v(\tilde{\beta}_\rho))_\rho$, therefore these vectors must be equal. Furthermore, the components $C^{(m, k)}$ in the limit of both families are equal, both having the node ∞ as special point. Hence there is an affine linear automorphism $f : \mathbb{C} \rightarrow \mathbb{C}, x \mapsto ax + b$ with $f(\gamma_l^j) = \tilde{\gamma}_l^j$ for all $j \in I(m, k)$. We want to define $\Gamma_m^j := (1 + s(a-1))\gamma_m^j + sb \in \mathbb{C}[s]$ and $\Gamma_l^j := (1-s)\gamma_l^j + s\tilde{\gamma}_l^j$ for $l \neq m$. Using this, we define a section $X_j := \sum_m \Gamma_m^j t^m \in \mathbb{C}[[t]][s]$ with $X_j(s=0) = x_j$ and $X_j(s=1) = \tilde{x}_j$.

As in Construction 2.2.21 we denote the lowest non-zero coefficient of β_ρ by b_ρ and the one of $\tilde{\beta}_\rho$ by \tilde{b}_ρ . We then obtain by (47) that the extended maps $\pi|_{C^{(0, k)}}$ and $\tilde{\pi}|_{C^{(0, k)}}$ are given by

$$b_\rho \prod_i (z_0^{(0, k)} \gamma_0^{k_i} - z_1^{(0, k)})^{\hat{e}_\rho^{(i)}} \quad \text{and} \quad \tilde{b}_\rho \prod_i (z_0^{(0, k)} \gamma_0^{k_i} - z_1^{(0, k)})^{\hat{e}_\rho^{(i)}} \quad \text{for } \rho \notin \sigma_v(1)$$

and 0 else, where the $\hat{e}_\rho^{(i)}$ come from the local degree Δ_v . We conclude that $b_\rho = \tilde{b}_\rho$ for $\rho \notin \sigma_v(1)$. If we use (47) to determine the maps on the other component $C^{(m,k)}$, we obtain the following.

$$\pi_\rho^{C^{(m,k)}} = \begin{cases} b_\rho \left(\prod_{j \notin I(1,m)} (\gamma_0^j - \gamma_0^k)^{\alpha_\rho^j} \right) (z_0^{(m,k)})^{e_\rho^{(0)}} \prod_i (z_0^{(m,k)} \gamma_m^{k_i} - z_1^{(m,k)})^{e_\rho^{(i)}} & \text{if } \rho \notin \sigma_w(1) \\ 0 & \text{if } \rho \in \sigma_w(1) \end{cases}$$

$$\tilde{\pi}_\rho^{C^{(m,k)}} = \begin{cases} \tilde{b}_\rho \left(\prod_{j \notin I(1,m)} (\gamma_0^j - \gamma_0^k)^{\alpha_\rho^j} \right) (\tilde{z}_0^{(m,k)})^{e_\rho^{(0)}} \prod_i (\tilde{z}_0^{(m,k)} \tilde{\gamma}_m^{k_i} - \tilde{z}_1^{(m,k)})^{e_\rho^{(i)}} & \text{if } \rho \notin \sigma_w(1) \\ 0 & \text{if } \rho \in \sigma_w(1) \end{cases}$$

Here $\tilde{z}_0^{(m,k)}, \tilde{z}_1^{(m,k)}$ are the coordinates on $C^{(m,k)}$ that are obtained from the family $\varphi_2^* \mathcal{F}_2$ and the integers $e_\rho^{(i)}$ come from the local degree Δ_w . A coordinate transformation via f yields

$$\tilde{\pi}_\rho^{C^{(m,k)}} = (a^{-1})^{e_\rho^{(0)}} \tilde{b}_\rho \left(\prod_{j \notin I(1,m)} (\gamma_0^j - \gamma_0^k)^{\alpha_\rho^j} \right) (z_0^{(m,k)})^{e_\rho^{(0)}} \prod_i (z_0^{(m,k)} \gamma_m^{k_i} - z_1^{(m,k)})^{e_\rho^{(i)}}$$

and we conclude $\tilde{b}_\rho = b_\rho a^{e_\rho^{(0)}}$ for $\rho \in \sigma_v(1)$. We now want to define $B_\rho := b_\rho$ if $\rho \notin \sigma_v(1)$ and $B_\rho := b_\rho (1 + s(a-1))^{e_\rho^{(0)}}$ for $\rho \in \sigma_v(1)$.

Let $S_0 = \text{Spec } \mathbb{C}[[t]][s]_{t(1+s(a-1))}$ and $\hat{x}_j = (1 : X_j) : S_0 \rightarrow \mathbb{P}_{S_0}^1$ define sections. Furthermore $(\hat{\pi}_\rho)_\rho$ with $\hat{\pi}_\rho := B_\rho t^{v(\beta_\rho)} \prod_j (z_0 X_j - z_1)^{\alpha_\rho^j}$ defines a morphism $\hat{\pi}$ to $X(\Sigma)$ such that $(\mathbb{P}_{S_0}^1, \text{pr}, S_0, \hat{x}_1, \dots, \hat{x}_n, \hat{\pi})$ is a family in W_Δ° . If we denote $S = \text{Spec } \mathbb{C}[[t]][s]_{1+s(a-1)}$, we can extend this family to a family in W_Δ over S , which works exactly as in Construction 2.2.21. We just have to replace γ_m^k by Γ_m^k, b_ρ by B_ρ and blow up in the disjoint subvarieties $Z(t, z^{(m-1,k)} - \Gamma_{m-1}^k)$ instead of $(1 : \gamma_{m-1}^k)$. For a fixed value s_0 of s we can determine the fibre over $\langle s - s_0, t \rangle$ by just plugging s_0 into B_ρ and X_j and this then into formula (47). On the component belonging to v we immediately see that this equals the corresponding component of \mathcal{C} . On the component belonging to w we have to apply the affine coordinate transformation $x \mapsto (1 + s_0(a-1))x + s_0 b$ first, but then we see that also this component equals the corresponding component of \mathcal{C} .

So we obtain a family $(\mathcal{C}, p, S, \hat{x}_1, \dots, \hat{x}_n, \hat{\pi})$ in W_Δ where all fibres over $Z(t)$ are equal to \mathcal{C} . Therefore the induced morphism $\psi : S \rightarrow M_\Delta$ satisfies $\psi(Z(t)) = \{\mathcal{C}\}$ and $\psi|_{Z(s)} = \psi_1$ and $\psi|_{Z(s-1)} = \psi_2$. As $\mathbb{C}[[t]][s]_{1+s(a-1)}$ is complete with respect to the ideal $\langle t \rangle$ the morphism ψ naturally lifts to $\hat{\psi} : S \rightarrow \hat{U}$. By construction we have $\hat{\psi}|_{Z(s)} = \nu_1 \circ \varphi_{b_1}$ and $\hat{\psi}|_{Z(s-1)} = \nu_2 \circ \varphi_{b_2}$ and therefore C_1 and C_2 are both contained in $\hat{\psi}(S)$ which is irreducible. \square

Tropical moduli spaces of covers and of lines in surfaces

In this final chapter we want to use the theory from the previous two chapters in order to obtain a few results. We will construct a one dimensional tropical fan $\mathcal{W}_{\Delta,Y}$ by using intersection theory on $W_{\Delta,Y}$ in certain cases. This will be the content of Section 3.1. In Section 3.2 we will show that if $L \subset \mathbb{P}^m$ is a line which tropicalises to L_1^m , then $\mathcal{W}_{\Delta,L}$ equals $\mathcal{M}_0(\Delta, L_1^m)$ from Definition 1.5.10 for a suitable choice of moduli data. Furthermore, we will show that every vertex type (Δ, L_1^m) is good. In Section 3.3 we will use the theory from the first chapter to construct moduli spaces of tropical lines in smooth surfaces in \mathbb{R}^3 . In particular this includes the tropical cubic surface. In the last section we will combine results from Chapters 1 and 2 to compute a few degrees of the virtual fundamental class $\deg [W_{\Delta,H}]^{vir}$, for degrees Δ of curves in L_2^3 and hyperplanes $H \subset \mathbb{P}^3$ tropicalising to L_2^3 .

3.1. Constructing local tropical moduli spaces

In this section we want to use intersection theory on $W_{\Delta,X(\Sigma)}$, respectively $W_{\Delta,Y}$, in the cases $\text{vdim}(\mathcal{Y}, \Delta) = 1$, respectively $\dim W_{\Delta,Y} = 1$, to define a tropical fan $\mathcal{W}_{\Delta,Y}$ of dimension one in $\mathcal{M}_0(\mathbb{R}^m, \Delta)$. As usual we will assume that $Y \subset X(\Sigma)$ is an integral subvariety and that the subfan \mathcal{Y} of Σ is the tropicalisation (with weights) of Y intersected with the dense torus of $X(\Sigma)$.

Definition 3.1.1. An *irreducible boundary divisor* of $W_{\Delta,Y}$ is an integral substack A of $\partial W_{\Delta,Y}$ which has codimension one in $W_{\Delta,Y}$. Note that by Lemma 2.4.4 there is a combinatorial type γ of degree Δ curves in \mathcal{Y} such that $A \hookrightarrow W_{\Delta,Y}(\gamma)$. Furthermore, in case $Y = X(\Sigma)$ and γ is of geometric dimension one, we have that $W_{\Delta,X(\Sigma)}(\gamma)$ is already irreducible and of codimension one, cf. Corollary 2.4.17.

Lemma 3.1.2. *Let A be an irreducible boundary divisor of $W_{\Delta,Y}$ with $A \hookrightarrow W_{\Delta,Y}(\gamma)$. Then there is a unique element $\tilde{v}_A \in \mathcal{M}_{0,n}$ such that*

$$(55) \quad \text{ft}_I(\tilde{v}_A) = \text{ord}_A \text{ft}_I^*(ij|kl)v_{ij} + \text{ord}_A \text{ft}_I^*(ik|jl)v_{ik} + \text{ord}_A \text{ft}_I^*(il|kj)v_{il}$$

for all $I = \{i, j, k, l\} \subset [n]$ of cardinality four. Furthermore, we can equip the n -marked abstract tropical curve $(\Gamma_A, x_1, \dots, x_n)$ represented by \tilde{v}_A with a map $h : |\Gamma_A| \rightarrow |\mathcal{Y}|$ such that $(\Gamma_A, x_1, \dots, x_n, h)$ is a tropical stable map of degree Δ and combinatorial type γ .

PROOF. By Proposition 2.6 of [Vis89] there is a finite and hence proper morphism from a scheme $\phi : U \rightarrow W_{\Delta,Y}$. We then want to compute the multiplicity of ϕ^*D to an irreducible component $V \subset \phi^{-1}A$ for some Cartier divisor D on $W_{\Delta,Y}$. This can be done by a local computation on a curve $j : S = \text{Spec } \mathcal{O}_{U,V} \rightarrow U$ through the generic point of V . Let $\mathfrak{m}_{U,V}$ be the closed point of S . We can normalise the curve $\nu : \tilde{S} \rightarrow S$ and consider a preimage point $P \in \nu^{-1}(\mathfrak{m}_{U,V})$ and an étale neighbourhood of P

$$g_P : D_{\mathfrak{K}} = \text{Spec } \mathfrak{K}[[t]] \cong \text{Spec } \hat{\mathcal{O}}_{\tilde{S},P} \rightarrow \tilde{S}.$$

Then $F_P := \phi \circ j \circ \nu \circ g_P$ clearly induces a family $(C, p, D_{\mathfrak{K}}, x_1, \dots, x_n, \pi)$ with generic fibre in $W_{\Delta,Y}^\circ$. We can apply Lemma 2.2.24 and obtain the existence of a $v_P \in \mathcal{M}_{0,n}$ such

that the abstract tropical curve represented by v_P can be equipped with a map to $|\mathcal{Y}|$ of combinatorial type γ . Furthermore,

$$\text{ft}_I(v_P) = \text{ord}_{\mathfrak{m}_P} F_P^* \text{ft}_I^*(ij|kl)v_{ij} + \text{ord}_{\mathfrak{m}_P} F_P^* \text{ft}_I^*(ik|jl)v_{ik} + \text{ord}_{\mathfrak{m}_P} F_P^* \text{ft}_I^*(il|kj)v_{il},$$

where \mathfrak{m}_P is the closed point of the étale neighbourhood of P . We have that

$$\text{ord}_V \phi^* D = \text{ord}_{\mathfrak{m}_{U,V}} j^* \phi^* D = \sum_{P \in \nu^{-1}(\mathfrak{m}_{U,V})} \text{ord}_{\mathfrak{m}_P} F_P^* D$$

and we define $v_V := \sum_{P \in \nu^{-1}(\mathfrak{m}_{U,V})} v_P$. Applying the projection formula to ϕ we obtain

$$\text{ord}_A D = \sum_V \deg(V/A) \text{ord}_V \phi^* D,$$

where the sum runs over all irreducible components of $\phi^{-1}A$. Finally we define $\tilde{v}_A := \sum_V \deg(V/A)v_V$, which then satisfies (55) by construction. Since \mathcal{Y} is a fan, $\mathcal{M}(\gamma) \subset \mathcal{M}_0(\mathbb{R}^m, \Delta)$ is a cone. Therefore also the abstract tropical curve represented by \tilde{v}_A can be equipped with a stable map to $|\mathcal{Y}|$ of combinatorial type γ . Uniqueness of \tilde{v}_A follows from Lemma 1.2.11. \square

Now we want to recover the map into $|\mathcal{Y}|$. As in Section 2.2 we will use approach (3) from Construction 1.2.20, so we choose two root leaves.

For this assume we have a cone $\sigma \in \Sigma$. Let $S_\sigma = \bigcup_{\tau \in \Sigma: \tau \geq \sigma} \tau(1) \setminus \sigma(1)$ which is in obvious bijection to $\text{Star}_\Sigma(\sigma)(1)$. We want to denote the images of the primitive generators u_ρ of the rays $\rho \in S_\sigma$ under the projection to \mathbb{R}^m/V_σ by f_ρ . These are then the primitive generators of the rays in $\text{Star}_\Sigma(\sigma)$.

Lemma 3.1.3. *Let A be an irreducible boundary divisor of $W_{\Delta,Y}$ with $A \hookrightarrow W_{\Delta,Y}(\gamma)$. Then by the previous lemma there is a unique $\tilde{v}_A \in \mathcal{M}_{0,n}$ satisfying (55) and representing an abstract tropical curve that can be equipped with a tropical stable map of degree Δ to $|\mathcal{Y}|$. So there is some $p_A \in \mathbb{R}^m$ such that $(\tilde{v}_A, p_A) \in \mathcal{M}_{0,n} \times \mathbb{R}^m \cong \mathcal{M}_0(\mathbb{R}^m, \Delta)$ represents such a map. For each $j \in \sigma \in \mathcal{Y}$ we obtain*

$$(56) \quad \text{ev}_j^{V_\sigma}(\tilde{v}_A, p_A) = \sum_{\rho \in S_\sigma} \text{ord}_A \text{ev}_j^* D_\rho f_\rho \in \mathbb{R}^m/V_\sigma.$$

PROOF. The proof works exactly as the one of the previous lemma, using $D = \text{ev}_j^* D_\rho$ and Lemma 2.2.25 instead. \square

For the rest of this section, we assume that there are $\delta_1, \delta_2 \in \Delta$ with $\delta_j \in \sigma_j^\circ$ for $\sigma_j \in \Sigma$ and $j = 1, 2$ such that $V_{\sigma_1} \oplus V_{\sigma_2} = \mathbb{R}^m$. We will fix x_1 and x_2 as root leaves for $\mathcal{M}_0(\mathbb{R}^m, \Delta)$.

Construction 3.1.4 (The fan $\mathcal{W}_{\Delta,Y}$). For every irreducible boundary divisor A of $W_{\Delta,Y}$ or of $W_{\Delta,X(\Sigma)}$ we obtain a unique element $\tilde{v}_A \in \mathcal{M}_{0,n}$ by Lemma 3.1.2. As $V_{\sigma_1} \cap V_{\sigma_2} = 0$ by assumption, we also obtain a unique $p_A \in \mathbb{R}^m$ such that $v_A := (\tilde{v}_A, p_A) \in \mathcal{M}_{0,n} \times \mathbb{R}^m \cong \mathcal{M}_0(\mathbb{R}^m, \Delta)$ satisfies (55) and (56). Recall that $\text{vdim}(\mathcal{Y}, \Delta)$ is the expected dimension of $W_{\Delta,Y}$, but note that it is not clear whether the following two cases will yield the same result or not, even if $\text{vdim}(\mathcal{Y}, \Delta) = \dim W_{\Delta,Y} = 1$.

Case 1: We have $\dim W_{\Delta,Y} = 1$. Let $\mathcal{W}_{\Delta,Y}$ be the one-dimensional fan whose rays are generated by the vectors v_A for all irreducible boundary divisors A of $W_{\Delta,Y}$. We define $r_A := v_A$ for every A . Assume that v_{A_1}, \dots, v_{A_s} are all vectors that generate some ray $\rho \in \mathcal{W}_{\Delta,Y}$. Then $\sum_{i=1}^s v_{A_i} = \omega u_\rho$ holds for some natural number ω and the primitive integer generator u_ρ of the ray. Let ω be the weight of the ray ρ .

Case 2: We have $\text{vdim}(\mathcal{Y}, \Delta) = 1$. Let $\mathcal{W}_{\Delta,Y}$ be the one-dimensional fan whose rays are generated by the vectors v_A for all irreducible boundary divisors A of $W_{\Delta,X(\Sigma)}$. Let E_Y be the vector bundle from Construction 2.3.3. As $\text{vdim}(\mathcal{Y}, \Delta) = 1$ we can define

$$m_A := \deg c_{\text{top}}(E_Y) \cap [A]$$

and $r_A := m_A v_A$ for all A . As before, assume that v_{A_1}, \dots, v_{A_s} are all vectors that generate some ray $\rho \in \mathcal{W}_{\Delta, Y}$. Then $\sum_{i=1}^s v_{A_i} = \omega u_\rho$ holds for some natural number ω and the primitive integer generator u_ρ of the ray. We define the weight of ρ in $\mathcal{M}_{\Delta, Y}$ as $\omega \sum_{i=1}^s m_{A_i}$.

So in both cases we obtain a weighted fan of dimension one. In order to prove that this is a balanced fan, we have to check $\sum_A r_A = 0$. This will be the content of the next lemma.

Lemma 3.1.5. *The weighted fan $\mathcal{W}_{\Delta, Y}$ from the previous construction is balanced, and the elements of its support represent tropical curves inside \mathcal{Y} .*

PROOF. Let the notation be as in the previous construction. To prove balancing it suffices to prove that $R = \sum_A r_A = 0$, where the sum runs over all irreducible boundary divisors of $W_{\Delta, Y}$ in case 1 and $W_{\Delta, X(\Sigma)}$ in case 2 of the previous construction. First of all we can apply Lemma 1.2.11 for the tropical forgetful maps and restrict to proving $\text{ft}_I(R) = 0$ for all $I = \{i, j, k, l\} \subset [n]$ of cardinality four. In $\mathcal{M}_{0, I}$ we obtain $\text{ft}_I(R) = \lambda_{ij} v_{ij} + \lambda_{ik} v_{ik} + \lambda_{il} v_{il}$. This is zero if and only if all three coefficients are equal. This is what we want to see now, by computing λ_{ij} .

First we consider case 2. Using linearity of the tropical map ft_I and Lemma 3.1.2 we obtain

$$\begin{aligned} \lambda_{ij} &= \sum_A m_A \text{ord}_A \text{ft}_I^*(ij|kl) \\ &= \sum_A \text{ord}_A \text{ft}_I^*(ij|kl) \deg c_{\text{top}}(E_Y) \cap [A] \\ &= \deg c_{\text{top}}(E_Y) \cap \left(\sum_A \text{ord}_A \text{ft}_I^*(ij|kl) [A] \right) \\ &= \deg c_{\text{top}}(E_Y) \cap (\text{ft}_I^*(ij|kl) \cdot [W_{\Delta, X(\Sigma)}]) \\ &= \deg \text{ft}_I^*(ij|kl) \cdot (c_{\text{top}}(E_Y) \cap [W_{\Delta, X(\Sigma)}]) \\ &= \deg \text{ft}_I^*(ij|kl) \cdot [W_{\Delta, Y}]^{\text{vir}}. \end{aligned}$$

The computations take place in $A_*(W_{\Delta, X(\Sigma)})_{\mathbb{Q}}$, and by the virtual fundamental class we mean its image in this Chow group. It is now obvious that $\lambda_{ij} = \lambda_{ik} = \lambda_{il}$ as $A_0(\overline{M}_{0, I}) \cong \mathbb{Z}$. Hence $R \in \mathcal{M}_0(\mathbb{R}^m, \Delta) \cong \mathcal{M}_{0, n} \times \mathbb{R}^m$ actually equals $R = (0, r)$ for some $r \in \mathbb{R}^m$.

Similarly to the above computation we consider $\text{ev}_j^{V_{\sigma_j}}(R) = \sum_\rho \lambda_\rho f_\rho$ for $j = 1, 2$ and show that it is zero. The same computation as above using Lemma 3.1.3 yields

$$\lambda_\rho = \deg \text{ev}_j^* D_\rho \cdot [W_{\Delta, Y}]^{\text{vir}} = \deg D_\rho \cdot (\text{ev}_j)_* [W_{\Delta, Y}]^{\text{vir}}$$

and therefore $(\lambda_\rho)_\rho$ is a (rational) Minkowski weight and $\text{ev}_j^{V_{\sigma_j}}(R) = 0$ for $j = 1, 2$. Hence also $r = 0$ and $R = 0$.

Case 1 works similarly. We do not have to deal with the Chern class there, as we can directly intersect with the usual fundamental class $[W_{\Delta, Y}]$ since it is one-dimensional.

To see that all the curves in $|\mathcal{W}_{\Delta, \mathcal{Y}}|$ are curves which map to $|\mathcal{Y}|$ we have to distinguish cases again. For case 1 this is clear by construction. So consider case 2 and assume that $A \hookrightarrow W_{\Delta, X(\Sigma)}(\gamma)$ for a combinatorial type γ of degree Δ curves in Σ . Furthermore, assume that curves of combinatorial type γ are not mapped to $|\mathcal{Y}|$. This means there is some flag f of γ which is mapped into the relative interior of a cell $\sigma_f \in \Sigma$ with $\sigma_f \notin \mathcal{Y}$. For $\beta \geq \gamma$ we can consider the flags of γ as a subset of the flags of β as in Construction 1.5.5. It is not difficult to see that in β the flag f is mapped into a cell τ_f with $\tau_f \geq \sigma_f$. This means that for every curve $(C, x_1, \dots, x_n, \pi) \in W_{\Delta, X(\Sigma)}^\circ(\beta)$ there is a node $P \in C$ with $\pi(P) \in O(\tau_f) \subset X(\Sigma)$. By Lemma 2.2 of [KP11] Y is already contained in $X(\mathcal{Y}) \hookrightarrow X(\Sigma)$. Using the orbit-cone-correspondence (see e.g. [CLS11] Theorem 3.2.6) we see that $O(\tau_f) \cap X(\mathcal{Y}) = \emptyset$ and therefore $O(\tau_f) \cap Y = \emptyset$. We conclude $W_{\Delta, X(\Sigma)}^\circ(\beta) \cap W_{\Delta, Y} = \emptyset$ for all $\beta \geq \gamma$. By Lemma 2.4.5

we have $W_{\Delta, X(\Sigma)}(\gamma) \cap W_{\Delta, Y} = \emptyset$ and hence $A \cap W_{\Delta, Y} = \emptyset$. This means $c_{top}(E_Y) \cap [A] = 0$ and $r_A = 0$. \square

After we defined the fan $W_{\Delta, Y}$, we can ask if we can really determine the vectors v_A from Construction 3.1.4. For case 1 we can solve this if Y is a line in projective space, cf. Section 3.2. For case 2 our methods unfortunately only apply in the case where $W_{\Delta, X(\Sigma)}$ is unibranch around general points of A , as we can only determine multiplicities of Cartier divisors on families of stable maps over a smooth irreducible curve. So if $W_{\Delta, X(\Sigma)}$ is not étale locally irreducible around A , the multiplicity of the divisor restricted to the curve will not be equal to the multiplicity of the divisor along A . There are only two cases where we know something about this, namely Lemmas 2.4.20 and 2.4.21. Therefore we can only prove the following restrictive result.

Lemma 3.1.6. *Let $|\Delta| \geq 3$ and assume γ is a combinatorial type of degree Δ curves in Σ of geometric dimension one and has at most two vertices. Then we obtain a unique element $v_\gamma := v_{W_{\Delta, X(\Sigma)}(\gamma)}$ as in Construction 3.1.4, and v_γ is the primitive integral generator of the ray $\mathcal{M}(\gamma)$ in $\mathcal{M}_0(\mathbb{R}^m, \Delta)$.*

PROOF. Let M denote the coarse moduli space of $W_{\Delta, X(\Sigma)}$ and let $p : W_{\Delta, X(\Sigma)} \rightarrow M$ denote the canonical proper morphism. Furthermore, let $M^\circ := p(W_{\Delta, X(\Sigma)}^\circ)$ and $M_\gamma^\circ := p(W_{\Delta, X(\Sigma)}^\circ(\gamma))$ for all combinatorial types γ of degree Δ curves in Σ . Let $D := \text{Spec } \mathbb{C}[[t]]$ and $D^* := \text{Spec } \mathbb{C}[[t]]_t$ and let \mathfrak{m} be the closed point of D . Let the α_ρ^j be coming from Δ as in Definition 2.2.7 and let $\delta_1, \delta_2 \in \Delta$ be root leaves as above, with $\delta_i \in \sigma_i^\circ$ for $i = 1, 2$. The idea of the proof is to write down a family over D for which we know that the multiplicities of divisors of the form $\text{ft}_I^*(ij|kl)$ and $\text{ev}_j^* D_\rho$ along \mathfrak{m} yield a v_γ that is the primitive integral vector of $\mathcal{M}(\gamma)$. The difficulty is to show that the multiplicities along \mathfrak{m} coincide with those along $W_{\Delta, X(\Sigma)}(\gamma)$. We want to use that M is unibranch around closed points of M_γ° to achieve this.

First let γ have only one vertex, which then is mapped into the relative interior of some ray $\xi \in \Sigma(1)$. Assume without loss of generality that $\xi \notin \sigma_1(1)$. Consider a family $\mathcal{F} = (\mathbb{P}_D^1, \text{pr}, D, x_1, \dots, x_n, \pi)$, where π is given by a tuple $(\beta_\rho \prod_j (z_0 x_j - z_1)^{\alpha_\rho^j})_\rho$ with $\beta_\rho, x_j \in \mathbb{C}^*$ for $\rho \neq \xi$ and $j \in [n]$ and $\beta_\xi = bt$ for $b \in \mathbb{C}^*$. The fibre \mathcal{C} over \mathfrak{m} is then a closed point of M_γ° . We obtain a morphism $\phi : D \rightarrow M$, induced by \mathcal{F} . We have clearly $\text{ord}_{\mathfrak{m}} \phi^* \text{ev}_1^* D_\xi = 1$. As M is smooth at \mathcal{C} by Lemma 2.4.20 and elements in M_γ° have no automorphisms, we conclude that $\text{ord}_{W_{\Delta, X(\Sigma)}(\gamma)} \text{ev}_1^* D_\xi = 1$. All other multiplicities follow from uniqueness of v_γ and that v_γ represents a curve of combinatorial type γ and $\mathcal{M}(\gamma)$ is a ray. This proves the claim.

Let now γ have two vertices v and w which are mapped into the relative interior of σ_v and σ_w , respectively. First assume that neither v nor w is two-valent. Denote the set of labels of leaves which are incident to w by J . Then the primitive generator of $\mathcal{M}(\gamma)$ is $v_J + r$ for some $r \in \mathbb{R}^m$. Let $\sum_{\rho \in \sigma_v(1)} v_\rho u_\rho$ be the image of the vertex v in the stable map represented by $v_J + r$. Of course, $v_\rho > 0$ for $\rho \in \sigma_v(1)$ and we set $v_\rho = 0$ for $\rho \notin \sigma_v(1)$. For $j \notin J$ let $x_j \in \mathbb{C}$ and for $j \in J$ let $x_j := \gamma + \gamma_1^j t \in \mathbb{C}[[t]]$. We choose the numbers such that the x_j for $j \in J$ and γ are pairwise distinct. Furthermore the γ_1^j for $j \in J$ shall be pairwise distinct. Then $x_j := (1 : x_j) : D^* \rightarrow \mathbb{P}_{D^*}^1$ defines sections and the tuple $(t^{v_\rho} \prod_j (z_0 x_j - z_1)^{\alpha_\rho^j})_\rho$ defines a morphism $\pi : \mathbb{P}_{D^*}^1 \rightarrow X(\Sigma)$. So we obtain a family $\mathcal{F} = (\mathbb{P}_{D^*}^1, \text{pr}, D^*, x_1, \dots, x_n, \pi)$ of stable maps in $W_{\Delta, X(\Sigma)}^\circ$. By Construction 2.2.21 we can extend this family (possibly after a finite base change) to a family over D whose special fibre \mathcal{C} over \mathfrak{m} is a closed point of M_γ° . As M is complete, the morphism induced by \mathcal{F} extends to a morphism $\phi : D \rightarrow M$. As M° is smooth, the normalisation $\nu : \tilde{M} \rightarrow M$ is an isomorphism restricted to the preimage of M° . Therefore we obtain $\tilde{\phi} : D^* \rightarrow \tilde{M}$ with $\phi = \nu \circ \tilde{\phi}$. Let now $I \subset [n]$ with $I = \{i, j, k, l\}$ and $I \cap J = \{i, j\}$. Then clearly

$\text{ord}_m \tilde{\phi}^* \text{ft}_I^*(ij|kl) = \text{ord}_m \phi^* \text{ft}_I^*(ij|kl) = 1$. Now M is unibranch around every closed point of M_γ° by Lemma 2.4.21, therefore $\nu^{-1}M_\gamma^\circ$ is irreducible. As \tilde{M} is normal, we conclude that $\text{ord}_{\nu^{-1}M_\gamma^\circ} \nu^* \text{ft}_I^*(ij|kl) = 1$. In particular $\nu : \nu^{-1}M_\gamma^\circ \rightarrow M_\gamma^\circ$ is a bijection on closed points, hence $\text{ord}_{M_\gamma^\circ} \text{ft}_I^*(ij|kl) = 1$ by the projection formula. General elements in M_γ° do not have automorphisms, hence we also have $\text{ord}_{W_{\Delta, X(\Sigma)}(\gamma)} \text{ft}_I^*(ij|kl) = 1$. All other multiplicities now follow from the uniqueness of the vector $v_\gamma = v_J + r'$ and that $\mathcal{M}(\gamma)$ is a ray. This yields $v_\gamma = v_J + r$ which finishes the proof.

If one of the vertices, say w is two-valent the proof works similar. In this case the primitive integral generator of $\mathcal{M}(\gamma)$ is given by some $r_1 + r_2 \in \mathbb{Z}^m / V_{\sigma_1} \oplus \mathbb{Z}^m / V_{\sigma_2}$ with $r_i \in \mathbb{Z}^m / V_{\sigma_i}$ for $i = 1, 2$. Let $\sum_{\rho \in \sigma_v(1)} v_\rho u_\rho$ be the image of the vertex v in the stable map represented by $r_1 + r_2$. Of course, $v_\rho > 0$ for $\rho \in \sigma_v(1)$ and we set $v_\rho = 0$ for $\rho \notin \sigma_v(1)$. Choose fixed distinct complex numbers $x_j \in \mathbb{C}^*$ and define the family $\mathcal{F} = (\mathbb{P}_{D^*}^1, \text{pr}, D^*, x_1, \dots, x_n, \pi)$, where the sections are given by $x_j := (1 : x_j) : D^* \rightarrow \mathbb{P}_{D^*}^1$ and the map π is given by the tuple $(t^{v_\rho} \prod_j (z_0 x_j - z_1)^{\alpha_j^\rho})_\rho$. The rest of the proof is the same as in the case above, we just have to consider suitable evaluations $\text{ev}_j^* D_\rho$ in order to recover $r_1 + r_2$ instead of using $\text{ft}_I^*(ij|kl)$. \square

Even though the above result is quite restrictive, we can use it to do some computations in Section 3.4. We suppose that a similar statement holds for general combinatorial types of degree Δ curves in Σ of geometric dimension one. Probably we might not obtain a primitive integral vector of $\mathcal{M}(\gamma)$, but only a "tropical meaningful" multiple of it. To be more precise, we suppose that the following is true.

Conjecture 3.1.7. Let $H = Z(\sum_{i=0}^m y_i) \subset \mathbb{P}^m = \text{Proj } \mathbb{C}[y_0, \dots, y_m]$ and let Δ be a degree of tropical curves in L_{m-1}^m . If the vertex type (L_{m-1}^m, Δ) satisfies $\text{vdim}(L_{m-1}^m, \Delta) = 0$ we want to assign a weight

$$(57) \quad \omega_{[(L_{m-1}^m, \Delta)]} := \deg [W_{\Delta, H}]^{\text{vir}}.$$

We conjecture that these moduli data turn every vertex type into a good one (in the sense of Definition 1.5.12). Furthermore we suppose that there is an equality of tropical cycles

$$\mathcal{M}_0(L_{m-1}^m, \Delta) = \mathcal{W}_{\Delta, H},$$

where the weights of the left cycle are as in Definition 1.5.10 with the moduli data given in (57). The cycle $\mathcal{W}_{\Delta, H}$ is as in Construction 3.1.4, case 2. Examples give evidence for this to be true. E.g. this conjecture holds for Examples 1.6.5 and 3.4.3 and a lot more examples which are not included in this thesis. Furthermore, we will see in the next section that this is true for $m = 2$, if we consider $\mathcal{W}_{\Delta, H}$ as in case 1 of Construction 3.1.4. I suppose that case 1 and case 2 of that construction will yield the same fan then, because we will see that the virtual fundamental class equals the usual one then.

3.2. The case of curves

The aim of this section is to prove that all vertex types (L_1^m, Δ) are good in the sense of Definition 1.5.12 with respect to a certain choice of moduli data, cf. Definition 3.2.8. Throughout this section let $L \subset \mathbb{P}^m$ denote a line, i.e. $L \cong \mathbb{P}^1$, such that its intersection with the dense torus tropicalises to L_1^m . We will always be given a degree $\Delta = (\delta_1, \dots, \delta_n)$ of tropical curves in L_1^m and a corresponding algebraic degree $d = \frac{1}{m-1} K_{L_1^m} \cdot \Delta$. In order to obtain something interesting let also $m \geq 2$. Throughout this section we want to denote the coordinate hyperplanes of \mathbb{P}^m by H_0, \dots, H_m . As before we denote the standard basis of \mathbb{R}^m by e_1, \dots, e_m and $e_0 = -\sum_{i=1}^m e_i$. For a vector $\delta_j \in \Delta$ there are unique integers $\alpha_i^j \in \mathbb{Z}_{\geq 0}$ for $0 \leq i \leq m$ with $\delta_j = \sum_{i=0}^m \alpha_i^j e_i$ and such that $\alpha_i^j > 0$ for at most one i .

As L is a curve, we will first state an important tool for studying covers of curves, the Riemann-Hurwitz formula.

Lemma 3.2.1 (Riemann-Hurwitz formula). *Let $\pi : Y \rightarrow X$ be a finite and separated morphism between smooth and complete curves over an algebraically closed field. Then*

$$2g(Y) - 2 = \deg \pi \cdot (2g(X) - 2) + \sum_{P \in Y} (f_P - 1),$$

where g denotes the genus of the curve and f_P is the ramification order at the point P . The degree $\deg \pi$ is the degree of the field extension $[K(Y) : K(X)]$ that is induced by π^* .

PROOF. This is [Har97], IV Corollary 2.4. □

Now we will review some deformation theory of covers following the paper [Vak00] of R. Vakil. For literature about deformation functors and miniversal families we refer to [Har10]. Deformations to a $\mathcal{C} = (C, x_1, \dots, x_n, \pi)$ in $\overline{M}_{0,n}(X, \beta)$ can be obtained from the complex

$$\underline{\Omega}_\pi = \left(\pi^* \Omega_X \longrightarrow \Omega_C \left(\sum_{j=1}^n x_j \right) \right)$$

where the first order deformations (those over $\text{Spec } \mathbb{C}[\varepsilon]/\langle \varepsilon \rangle$) are given by $\text{Ext}^1(\underline{\Omega}_\pi, \mathcal{O}_C)$ and the obstruction space is given by $\text{Ext}^2(\underline{\Omega}_\pi, \mathcal{O}_C)$.

For $\mathcal{C} = (C, x_1, \dots, x_n, \pi) \in \overline{M}_{0,n}(L, d)$ a subset $A \subset C$ is called *special locus*, if it is a connected component of a fibre of π which is *not* a reduced unmarked point. So the special loci are components on which π is constant, ramification points, nodes or marked points.

Let F_e denote the deformation functor of the étale neighbourhood $e : \hat{C} \rightarrow C$ of some special locus A , which is defined as follows. Consider tuples $(\hat{C}, p, \text{Spec } R, \hat{\pi}, (\hat{x}_i)_{i \in I})$ where $p : \hat{C} \rightarrow \text{Spec } R$ is a flat morphism, $\hat{\pi} : \hat{C} \rightarrow L$ is a morphism and $\hat{x}_i : \text{Spec } R \rightarrow \hat{C}$ is a section of p for each $i \in I$. Here I is the set of indices such that $x_i \in A$ and (R, \mathfrak{m}) is a local artinian \mathbb{C} -algebra with $R/\mathfrak{m} \cong \mathbb{C}$. Two such tuples $(\hat{C}, p, \text{Spec } R, \hat{\pi}, (\hat{x}_i)_{i \in I})$ and $(\hat{C}', p', \text{Spec } R, \hat{\pi}', (\hat{x}'_i)_{i \in I})$ are *isomorphic* if there is an isomorphism $\phi : \hat{C} \rightarrow \hat{C}'$ over $\text{Spec } R$ such that $\hat{\pi} = \hat{\pi}' \circ \phi$ and $\hat{x}'_i = \phi \circ \hat{x}_i$ for all $i \in I$. We denote by $F_e(\text{Spec } R)$ the set of isomorphism classes of tuples $(\hat{C}, p, \text{Spec } R, \hat{\pi}, (\hat{x}_i)_{i \in I})$ such that the restriction to the fibre of p over \mathfrak{m} is isomorphic to $(\hat{C}, p, \text{Spec } \mathbb{C}, \pi \circ e, (e^{-1}(x_i))_{i \in I})$.

We want to define another functor F_e^Δ as follows. Let $F_e^\Delta(\text{Spec } R) \subset F_e(\text{Spec } R)$ be the set of isomorphism classes $(\hat{C}, p, \text{Spec } R, \hat{\pi}, (\hat{x}_i)_{i \in I})$ which additionally satisfy

- (1) $\hat{\pi} \circ \hat{x}_j : \text{Spec } R \rightarrow H_i$ for all $j \in I$ with $\alpha_i^j > 0$
- (2) $\hat{\pi}^* H_i - \sum_{j \in I} \alpha_i^j \hat{x}_j = 0 \in A_0(\hat{\pi}^{-1} H_i)$ for $i = 0, \dots, m$.

Let $F_{\mathcal{C}}$ denote the functor describing deformations of an element $\mathcal{C} \in \overline{M}_{0,n}(L, d)$ and let $F_{\mathcal{C}}^\Delta$ denote the functor describing deformations of a stable map \mathcal{C} in $M_{\Delta, L}$, cf. Definition 2.2.10.

Let $\text{Def}_{\mathcal{C}}$ be the miniversal deformation space of the functor $F_{\mathcal{C}}$ and $\text{Def}_{\mathcal{C}}^\Delta$ the miniversal deformation space of the functor $F_{\mathcal{C}}^\Delta$. Then $\text{Def}_{\mathcal{C}}$ is a formal neighbourhood of \mathcal{C} in $\overline{M}_{0,n}(L, d)$ and $\text{Def}_{\mathcal{C}}^\Delta$ is a formal neighbourhood of \mathcal{C} in $M_{\Delta, L}$. Furthermore let Def_{F_e} be the miniversal deformation space of the functor F_e and $\text{Def}_{F_e}^\Delta$ the miniversal deformation space of the functor F_e^Δ .

Let $\mathcal{C} = (C, x_1, \dots, x_n, \pi)$ in $\overline{M}_{0,n}(L, d)$ have special loci A_1, \dots, A_r and choose étale neighbourhoods $e_k : \hat{C}_k \rightarrow C$ of each special locus $k = 1, \dots, r$. In Proposition 4.3 of [Vak00] it is shown that there is an isomorphism $\text{Ext}^i(\underline{\Omega}_\pi, \mathcal{O}_C) \cong \bigoplus_k \text{Ext}^i(e_k^* \underline{\Omega}_\pi, \mathcal{O}_{\hat{C}_k})$ for all i . Furthermore $e_k^* \underline{\Omega}_\pi = \underline{\Omega}_{e_k \circ \pi}$. Recalling that the tangent space of a deformation functor is its value at $\text{Spec } \mathbb{C}[\varepsilon]/\langle \varepsilon \rangle$, we obtain the following lemma.

Lemma 3.2.2. *We have natural isomorphisms of miniversal deformation spaces $\text{Def}_{\mathcal{C}} \cong \prod_k \text{Def}_{e_k}$ and of tangent spaces $T_{F_{\mathcal{C}}} \cong \bigoplus_k T_{F_{e_k}}$. Furthermore $\text{Def}_{\mathcal{C}}^{\Delta} \cong \prod_k \text{Def}_{e_k}^{\Delta}$ and $T_{F_{\mathcal{C}}}^{\Delta} \cong \bigoplus_k T_{F_{e_k}}^{\Delta}$.*

In particular the miniversal deformation spaces and tangent spaces do not depend on the choice of the étale neighbourhood of A_k . We therefore write $\text{Def}_{F_{e_k}} =: \text{Def}_{A_k}$, $\text{Def}_{F_{e_k}}^{\Delta} =: \text{Def}_{A_k}^{\Delta}$, $T_{F_{e_k}} =: T_{A_k}$ and $T_{F_{e_k}}^{\Delta} =: T_{A_k}^{\Delta}$.

PROOF. The claim without Δ is Proposition 4.3 of [Vak00]. This also implies the claim with Δ because the conditions defining $M_{\Delta,L}$ in Definition 2.2.10 restrict to the conditions defining $F_{e_k}^{\Delta}$ on étale neighbourhoods e_k of the special loci of \mathcal{C} . \square

Lemma 3.2.3. *Let $\mathcal{C} = (C, x_1, \dots, x_n, \pi) \in \overline{M}_{0,n}(L, d)$ be a stable map and A a special locus of \mathcal{C} . If A is an unmarked f_A -fold ramification point, then $\dim T_A = \dim T_A^{\Delta} = f_A - 1$. If $A = x_j$ is a marked point for which there is some i with $\alpha_i^j > 0$, then $\dim T_A = 0$ and $\dim T_A^{\Delta} = f_A$ else. In both cases we have $\dim T_A = f_A$.*

PROOF. First we consider the case of an unmarked ramification. We can choose any étale neighbourhood $e : C' \rightarrow C$ of A by the previous lemma, for example $C' = \text{Spec } \mathbb{C}[[t]]$. Then the pull back $\pi' = \pi \circ e$ maps into an affine open subset $D := \text{Spec } \mathbb{C}[z] \subset L$ and we can assume that $\pi'(m) = \langle z \rangle$ for the closed point m of C' . Therefore π' is given by a \mathbb{C} -algebra homomorphism $z \mapsto \alpha t^{f_A}$ for some $\alpha \in \mathbb{C}^*$. As C' is smooth it is also rigid, i.e. all its first order deformations are trivial ([Har10], Example 5.3.1). Hence we can assume that first order deformations of C' look like

$$p : \mathcal{D} := \text{Spec } \mathbb{C}[[t]][\varepsilon] / \langle \varepsilon \rangle \rightarrow D_{\varepsilon} := \text{Spec } \mathbb{C}[\varepsilon] / \langle \varepsilon \rangle,$$

where p is just the projection. We obtain automorphisms of \mathcal{D} over D_{ε} from \mathbb{C} -algebra homomorphisms ϕ with $\phi(\varepsilon) = \varepsilon$ and $\phi(t) = at + \varphi\varepsilon$, with $a \in \mathbb{C}^*$ and $\varphi \in \mathbb{C}[[t]]$. The inverse is given by $\phi^{-1}(\varepsilon) = \varepsilon$ and $\phi^{-1}(t) = a^{-1}(t - \varphi(a^{-1}t)\varepsilon)$, which is easily checked using Taylor series expansion. The deformed map $\hat{\pi} : \mathcal{D} \rightarrow \text{Spec } \mathbb{C}[z]$ is given by $z \mapsto \alpha t^{f_A} + g\varepsilon$, where $g \in \mathbb{C}[[t]]$. Let $\beta \in \mathbb{C}$ be such that $\beta^{f_A} = \alpha^{-1}$ and let q denote the degree $f_A - 2$ polynomial which consists of all terms of $g(\beta t)$ of order up to $f_A - 2$. Then reparameterising with the automorphism $\phi(t) = \beta t + \varphi\varepsilon$ with $\varphi = f_A^{-1} \beta^{1-f_A} (q - g(\beta t)) t^{-(f_A-1)}$ yields the map $z \mapsto t^{f_A} + q\varepsilon$. One can see that the only possible deformations up to isomorphisms are of the form $z \mapsto t^{f_A} + (\sum_{k=0}^{f_A-2} \gamma_k t^k) \varepsilon$ with $\gamma_k \in \mathbb{C}$. Counting coefficients yields the claim.

If A is marked, we additionally have a section $x : D_{\varepsilon} \rightarrow \mathcal{D}$ given by $\varepsilon \mapsto \varepsilon$ and $t \mapsto \chi\varepsilon$ with $\chi \in \mathbb{C}$. Reparameterising with the automorphism $\phi(t) = t - \chi\varepsilon$ we can assume that the section is constant zero. As above, a deformation of the map is given by $z \mapsto \alpha t^{f_A} + g\varepsilon$ with $g \in \mathbb{C}[[t]]$. If we reparameterise this, we have to restrict to those automorphisms ϕ' with $\phi'(t) = at + \varphi'\varepsilon$ where $\varphi' \in \mathfrak{m} \subset \mathbb{C}[[t]]$ in order to keep the section constant. Let q denote the sum of all terms of $g(\beta t)$ up to order $f_A - 1$ and choose $\varphi' = f_A^{-1} \beta^{1-f_A} (q - g(\beta t)) t^{-(f_A-1)} \in \mathfrak{m}$. Then we obtain $z \mapsto t^{f_A} + q\varepsilon$ after reparameterising the map with $\phi'(t) = \beta t + \varphi'\varepsilon$. Therefore, up to isomorphism, each deformed map $\hat{\pi}$ is of the form

$$(58) \quad z \mapsto t^{f_A} + \varepsilon \sum_{k=0}^{f_A-1} \gamma_k t^k$$

with $\gamma_k \in \mathbb{C}$ and the constant section $t \mapsto 0$ and $\varepsilon \mapsto \varepsilon$. Counting coefficients yields the claim. If $A = x_j$ with $\alpha_i^j > 0$, then we must have $f_A = \alpha_i^j$. We have $H_i \cap L = \{z = 0\}$ and hence $\hat{\pi}^* H_i = t^{f_A} + \varepsilon \sum_{k=0}^{f_A-1} \gamma_k t^k = t^{f_A}$, since the section is constant zero. Thus $\gamma_0 = \dots = \gamma_{f_A-1} = 0$ and the claim follows. \square

Lemma 3.2.4. *For a degree Δ of tropical curves in L_1^m we have that $\dim W_{\Delta,L} = \text{vdim}(L_1^m, \Delta)$, if $W_{\Delta,L} \neq \emptyset$. Furthermore $W_{\Delta,L}$ is a scheme and $W_{\Delta,L}^{\circ}$ is smooth.*

PROOF. The line $L \subset \mathbb{P}^m$ is the intersection of $m - 1$ hyperplanes $H'_1, \dots, H'_{m-1} \subset \mathbb{P}^m$. Construction 2.3.3 provides vector bundles $E_{H'_i}$ on $\overline{M}_{0,n}(\mathbb{P}^m, d)$ with global sections s_i , such that $W_{\Delta, L}$ is the vanishing locus of the sections s_1, \dots, s_{m-1} restricted to W_{Δ, \mathbb{P}^m} , with its reduced structure. As each $E_{H'_i}$ is of rank $d + 1$ we conclude that every irreducible component of $W_{\Delta, L}$ has dimension at least $\dim W_{\Delta, \mathbb{P}^m} - (m - 1)(d + 1) = n - (m - 1)d - 2 = \text{vdim}(L_1^m, \Delta)$.

As $m \geq 2$, we conclude that every vertex of a combinatorial type of degree Δ curves in L_1^m is at least three-valent. But this means by Theorem 2.2.18 that no curve in $W_{\Delta, L}$ has non-trivial automorphisms. Therefore $W_{\Delta, L}$ is a scheme. We will now compute the dimension of the tangent space of a point of $W_{\Delta, L}^\circ$ and therefore also an upper bound for the dimension of the scheme. Given any curve $\mathcal{C} = (\mathbb{P}^1, x_1, \dots, x_n, \pi) \in W_{\Delta, L}^\circ$, the special loci are x_1, \dots, x_n and possibly unmarked ramifications p_1, \dots, p_r . As \mathcal{C} has no automorphisms, we have that

$$T_{W_{\Delta, L}^\circ, \mathcal{C}} = T_{\mathcal{C}}^\Delta = \bigoplus_{j: \delta_j \neq 0} T_{x_j}^\Delta \oplus \bigoplus_{j: \delta_j = 0} T_{x_j}^\Delta \oplus \bigoplus_i T_{p_i}^\Delta$$

by Lemma 3.2.2. By Lemma 3.2.3 we have $\dim T_{p_i}^\Delta = f_{p_i} - 1$ for $i = 1, \dots, r$. The same lemma tells us $\dim T_{x_j}^\Delta = 0$ if $\delta_j \neq 0$ and $\dim T_{x_j}^\Delta = f_{x_j}$ if $\delta_j = 0$. Therefore

$$\begin{aligned} \dim T_{W_{\Delta, L}^\circ, \mathcal{C}} &= \sum_{j: \delta_j = 0} f_{x_j} + \sum_{i=1}^r (f_{p_i} - 1) \stackrel{(a)}{=} 2d - 2 - \sum_{j: \delta_j \neq 0} f_{x_j} + n \\ &= n - d(m - 1) - 2 = \text{vdim}(L_1^m, \Delta) \end{aligned}$$

where equality (a) follows from the Riemann-Hurwitz formula. Note that this also implies that the dimension of the tangent space is equal to the dimension of the scheme. Therefore $W_{\Delta, L}^\circ$ is smooth. \square

Definition 3.2.5 (Hurwitz numbers). If $\text{vdim}(L_1^m, \Delta) = 0$ we have $\dim W_{\Delta, L} = 0$ by the previous lemma. Therefore $W_{\Delta, L} = W_{\Delta, L}^\circ$ is a scheme. We define the *Hurwitz number* $H_{0,d}(\Delta)$ as the degree of the fundamental class

$$H_{0,d}(\Delta) := \deg [W_{\Delta, L}].$$

This is the number of degree d covers of \mathbb{P}^1 by \mathbb{P}^1 with ramifications prescribed by Δ . In the literature each cover is usually weighted by the inverse of the number of its automorphisms, which in our case is always 1. However some authors do not require the ramification points to be marked.

Remark 3.2.6 (Computing Hurwitz numbers). The Hurwitz number $H_{0,d}(\Delta)$ can be computed by pure combinatorics. Let S_d denote the symmetric group on $[d]$. Then $H_{0,d}(\Delta)$ is the number of tuples of cycles $(\sigma_1, \dots, \sigma_n)$ such that

- (1) if $\delta_j = \alpha_i^j e_i$ for some i with $\alpha_i^j > 0$, then σ_j is an α_i^j -cycle
- (2) $\sigma_1 \cdots \sigma_n = \text{id}$
- (3) the group $\langle \sigma_1, \dots, \sigma_n \rangle$ acts transitively on $[d]$.

This follows from the Riemann Existence Theorem which can be found, for example, in the book [Don11], Theorem 2 of Section 4.2.

If $m = 2$ then L_1^2 is a hypersurface in \mathbb{R}^2 . Additionally, also $L \subset \mathbb{P}^2$ is a hypersurface and we can ask for the relation between the virtual fundamental class $[W_{\Delta, L}]^{\text{vir}}$, that was only defined for hypersurfaces, and the usual fundamental class $[W_{\Delta, L}]$.

Lemma 3.2.7. *Let Δ be a degree of tropical curves in L_1^2 , i.e. $L \subset \mathbb{P}^2$ is a line which tropicalises to L_1^2 . Then the virtual fundamental class from Definition 2.3.4 coincides with the usual fundamental class*

$$[W_{\Delta, L}] = [W_{\Delta, L}]^{\text{vir}} \in A_*(W_{\Delta, L})_{\mathbb{Q}}.$$

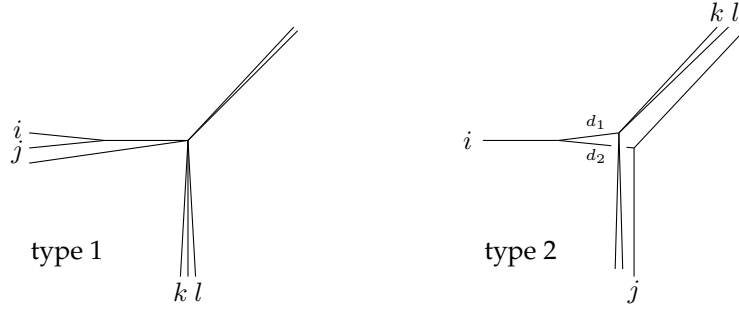

FIGURE 4. The different combinatorial situations (d_i denotes the weight of the edges)

PROOF. Let E_L and s_L be as in Construction 2.3.3. It is known that the global section s_L of E_L on $\overline{M}_{0,n}(\mathbb{P}^2, d)$ has the stack theoretic zero locus $Z(s_L) = \overline{M}_{0,n}(L, d)$, cf. Section 2.1 of [Pan98]. Then $W_{\Delta, L}^\circ = W_{\Delta, \mathbb{P}^2} \cap M_{0,n}(L, d)$ intersect in the correct dimension by Lemma 3.2.4. Let V be an irreducible component of $W_{\Delta, L}$. Clearly V is the closure of an irreducible component V° of $W_{\Delta, L}^\circ$. We will show that $M_{0,n}(L, d)$ and $W_{\Delta, \mathbb{P}^2}^\circ$, which are both smooth schemes, intersect transversally at closed points of V° . This can be achieved by considering the tangent spaces of both schemes at the intersection points. Let $\mathcal{C} \in V^\circ \subset M_{0,n}(L, d) \cap W_{\Delta, \mathbb{P}^2}^\circ$ be a closed point. Then a tangent vector to $M_{0,n}(\mathbb{P}^2, d)$ at \mathcal{C} which is also tangent to $M_{0,n}(L, d)$ and $W_{\Delta, \mathbb{P}^2}^\circ$ is given by a first order deformation of \mathcal{C} which holds the image L of π rigid and also preserves the multiplicities of $\pi^* H_i$ to x_j . By Lemma 3.2.2 it suffices to study the first order deformations of étale neighbourhoods of the special loci of \mathcal{C} , which are just the markings x_1, \dots, x_n and unmarked ramification points p_1, \dots, p_r in this case. As we explained in the proof of Lemma 3.2.4 we have

$$T_{M_{0,n}(\mathbb{P}^2, d), \mathcal{C}} \supset T_{M_{0,n}(L, d), \mathcal{C}} \cap T_{W_{\Delta, \mathbb{P}^2}^\circ, \mathcal{C}} = \bigoplus_{j: \delta_j=0} T_{x_j}^\Delta \oplus \bigoplus_i T_{p_i}^\Delta = T_{V^\circ, \mathcal{C}}.$$

As all schemes involved here are smooth and $W_{\Delta, \mathbb{P}^2}^\circ$ and $M_{0,n}(L, d)$ intersect in the right dimension, we conclude that $T_{M_{0,n}(\mathbb{P}^2, d), \mathcal{C}} = T_{M_{0,n}(L, d), \mathcal{C}} + T_{W_{\Delta, \mathbb{P}^2}^\circ, \mathcal{C}}$, i.e. the intersection is transversal. Hence $[V]$ occurs with multiplicity 1 in the usual and the virtual fundamental class. \square

Definition 3.2.8 (Moduli data for curves). To a vertex type (L_1^m, Δ) with $\text{rdim}(L_1^m, \Delta) = \text{vdim}(L_1^m, \Delta) = 0$ we want to assign the weight $\omega_{[(L_1^m, \Delta)]} := H_{0,d}(\Delta)$. To a vertex type $(L_0^{m-1} \times \mathbb{R}, \Delta)$ of resolution dimension zero we want to assign the weight $\omega_{[(L_0^{m-1} \times \mathbb{R}, \Delta)]} := 1$. Note that by the previous lemma these weights equal the weights defined in Conjecture 3.1.7 for $m = 2$.

Lemma 3.2.9. *If $W_{\Delta, L}(\gamma) \neq \emptyset$, then γ is an admissible combinatorial type in terms of Section 1.5.*

PROOF. If γ is not admissible, i.e. there is some vertex v with $\text{rdim}(v) < 0$, then this must be a vertex which is mapped to the origin. The Riemann-Hurwitz formula tells us that $W_{\Delta, L} = \emptyset$ and by Theorem 2.2.18 there can be no stable map in $W_{\Delta, L}(\gamma)$. \square

We want to determine the fan $\mathcal{W}_{\Delta, L}$ from Construction 3.1.4, case 1 later on. Therefore we want to compute the multiplicities of divisors of the form $\text{ft}_j^*(ij|kl)$ to the boundary points $\partial W_{\Delta, L}$ in case $\text{vdim}(L_1^m, \Delta) = 1$. By Lemma 3.2.4 this means that also $\dim W_{\Delta, L} = 1$, which was required for case 1 of that construction.

Lemma 3.2.10. *Let $\text{vdim}(L_1^m, \Delta) = 1$ and let $\mathcal{C} \in W_{\Delta, L}(\gamma)$ where γ is of type 1 as in Figure 4. Then*

$$(59) \quad \text{ord}_{\mathcal{C}} \text{ft}_I^*(ij|kl) = 1$$

PROOF. By assumption the stable map $\mathcal{C} = (C, x_1, \dots, x_n, \pi)$ has two irreducible components $C = C_0 \cup C_1$ such that $\pi|_{C_0}$ is constant, $x_i, x_j \in C_0$ and all other marked points lie on C_1 . Assume that $\delta_i = d_2 e_s$ and $\delta_j = d_1 e_s$ for some $0 \leq s \leq m$ and define $d = d_1 + d_2$.

Let M° denote the closed subscheme of $M_{0, I}(\mathbb{P}^1, d)$ whose closed points are exactly those stable maps $(\mathbb{P}^1, x_i, x_j, x_k, x_l, \pi)$ such that $\pi(x_i) = \pi(x_j) = 0$, $\pi(x_l) = \infty$, $\pi(x_k) = 1$ and $\pi^*0 = d_1 x_j + d_2 x_i$ and $\pi^*\infty = dx_l$.

Let $S := \text{Spec} \left(\mathbb{C}[\lambda, w]_{\lambda w(1-w)} / \langle \lambda w^{d_2} - (1-w)^{d_1} \rangle \right)$ and consider the family given by $\mathcal{U} = (\mathbb{P}_S^1, \text{pr}, S, \tilde{x}_i, \tilde{x}_j, \tilde{x}_k, \tilde{x}_l, \tilde{\pi})$, with $\tilde{x}_l = 1$, $\tilde{x}_i = 0$, $\tilde{x}_j = \infty$ and $\tilde{x}_k = (1 : w)$. Furthermore let $\tilde{\pi}$ be given by the tuple $((z_0 - z_1)^d, \lambda z_0^{d_1} z_1^{d_2})$, where z_0, z_1 are the coordinates of \mathbb{P}_S^1 . It is not difficult to see that $M^\circ \cong S$, because the stable maps in M° are exactly the stable maps in the family \mathcal{U} .

We even have an isomorphism $\psi : \text{Spec} \mathbb{C}[w]_{w(1-w)} \xrightarrow{\sim} S$, induced by the \mathbb{C} -algebra isomorphism $w \mapsto w$ and $\lambda \mapsto (1-w)^d w^{-d_2}$. We can now extend the pull back $\psi^* \mathcal{U}$ to a family over $\text{Spec} \mathbb{C}[w]_w$ with fibre $\mathcal{C}' = (C', x'_i, x'_j, x'_k, x'_l, \pi')$ over 1. An easy computation (e.g. use formula 47) shows that C' has two irreducible components C'_0 and C'_1 such that $\pi'|_{C'_0}$ is constant, $x'_i, x'_j \in C'_0$ and $x'_k, x'_l \in C'_1$. The extended family induces a morphism $\varphi : \text{Spec} \mathbb{C}[w]_w \rightarrow M$ into the closure M of M° in $\overline{M}_{0, I}(\mathbb{P}^1, d)$.

Let F_I denote the composition of the forgetful morphism $\text{ft}'_I : M \rightarrow \overline{M}_{0, I}$ with the morphism φ . Then we can see that $F_I^*(ij|kl) = w - 1$ which vanishes with order 1 at 1. By the projection formula we also obtain $\text{ord}_{\mathcal{C}'} (\text{ft}'_I)^*(ij|kl) = 1$.

The special loci of \mathcal{C}' are C'_0 and the marked points x'_k and x'_l . As étale neighbourhoods of x'_k and x'_l are not deformed in M° , we conclude from Lemma 3.2.2 that a formal neighbourhood of \mathcal{C}' in M is isomorphic to $\text{Def}_{C'_0}^\Delta$. We obtain $\text{Def}_{C'_0}^\Delta \cong \text{Def}_{C_0}^\Delta$, as C and C' are étale locally isomorphic around C_0 and C'_0 . Furthermore $\text{Def}_C^\Delta \cong \text{Def}_{C_0}^\Delta$ as $\text{vdim}(L_1^m, \Delta) = \dim W_{\Delta, L} = 1$ and hence $\dim \text{Def}_A^\Delta = 0$ for the other special loci A of \mathcal{C} . This means that $W_{\Delta, L}$ and M have formal neighbourhoods around \mathcal{C} and \mathcal{C}' which are isomorphic. Furthermore the forgetful morphisms ft_I and ft'_I to $\overline{M}_{0, I}$ correspond to each other via this isomorphism, thus $\text{ord}_{\mathcal{C}} \text{ft}_I^*(ij|kl) = \text{ord}_{\mathcal{C}'} (\text{ft}'_I)^*(ij|kl) = 1$. \square

Lemma 3.2.11. *Let $\text{vdim}(L_1^m, \Delta) = 1$ and let $\mathcal{C} \in W_{\Delta, L}(\gamma)$ where γ is of type 2 as in Figure 4. Then*

$$(60) \quad \text{ord}_{\mathcal{C}} \text{ft}_I^*(ij|kl) = d_1$$

PROOF. By assumption the stable map $\mathcal{C} = (C, x_1, \dots, x_n, \pi)$ has three irreducible components $C = C_0 \cup C_1 \cup C_2$ such that $\pi|_{C_0}$ is constant, $x_i \in C_0$ is the only marked point on C_0 , $x_j \in C_2$ and $x_k, x_l \in C_1$. Assume that $\delta_i = d e_s$ for some $0 \leq s \leq m$ and let d_i be the multiplicity of $(\pi|_{C_i})^* H_s$ at the node $C_0 \cap C_i$ for $i = 1, 2$. Then we must have $d = d_1 + d_2$ (cf. Remark 2.2.11).

Let M° denote the closed subscheme of $M_{0, I}(\mathbb{P}^1, d)$ whose closed points are exactly those stable maps $(\mathbb{P}^1, x_i, x_j, x_k, x_l, \pi)$ such that $\pi(x_k) = \pi(x_j) = 0$, $\pi(x_i) = \infty$, $\pi(x_l) = 1$ and $\pi^*0 = d_1 x_j + d_2 x_k$ and $\pi^*\infty = dx_i$.

Let $S := \text{Spec} \left(\mathbb{C}[\lambda, w]_{\lambda w(1-w)} / \langle \lambda - w^{d_1} (1-w)^{d_2} \rangle \right)$ and consider the family given by $\mathcal{U} = (\mathbb{P}_S^1, \text{pr}, S, \tilde{x}_i, \tilde{x}_j, \tilde{x}_k, \tilde{x}_l, \tilde{\pi})$, with $\tilde{x}_k = 1$, $\tilde{x}_j = 0$, $\tilde{x}_i = \infty$ and $\tilde{x}_l = (1 : w)$. Furthermore let $\tilde{\pi}$ be given by the tuple $(\lambda z_0^d, (z_0 - z_1)^{d_2} z_1^{d_1})$, where z_0, z_1 are the coordinates of \mathbb{P}_S^1 . It is not

difficult to see that $M^\circ \cong S$, because the stable maps in M° are exactly the stable maps in the family \mathcal{U} .

We have an isomorphism $\psi : \text{Spec } \mathbb{C}[w]_{w(1-w)} \xrightarrow{\sim} S$, induced by the \mathbb{C} -algebra isomorphism $w \mapsto w$ and $\lambda \mapsto w^{d_1}(1-w)^{d_2}$. We can extend the family $\psi^* \mathcal{U}$ (after a suitable finite base change, e.g. $1-w \mapsto (1-w)^{d_1}$ will do) to a family over $\text{Spec } \mathbb{C}[w]_{1-w}$ with fibre $C' = (C', x'_i, x'_j, x'_k, x'_l, \pi')$ over 1. An easy computation (e.g. use formula 47) shows that C' has three irreducible components C'_0, C'_1 and C'_2 such that $x'_i \in C'_0, x'_k, x'_l \in C'_2$ and $x'_j \in C'_1$. Furthermore $\pi'|_{C'_0}$ is constant, $\pi'|_{C'_1}$ has degree d_1 and $\pi'|_{C'_2}$ has degree d_2 .

Let M denote the closure of M° in $\overline{M}_{0,I}(\mathbb{P}^1, d)$ and let N denote the coarse moduli space of M with the canonical proper morphism $p : M \rightarrow N$. Then the forgetful morphism $\text{ft}'_I : M \rightarrow \overline{M}_{0,I}$ factors through N as $\text{ft}'_I = \tilde{\text{ft}}_I \circ p$. The family $\psi^* \mathcal{U}$ induces a morphism $\varphi' : \text{Spec } \mathbb{C}[w]_{w(1-w)} \rightarrow N$. As N is complete φ' extends to $\varphi : \text{Spec } \mathbb{C}[w]_w \rightarrow N$ with $\varphi(1) = C'$. Let $F_I := \tilde{\text{ft}}_I \circ \varphi$. Then clearly $F_I^*(ij|kl) = w - 1$ vanishes with order 1 at 1. As φ' is one-to-one, we obtain that $\text{ord}_{C'} \tilde{\text{ft}}_I^*(ij|kl) = 1$ holds on the coarse moduli space N . The curve C' has d_1 automorphisms and therefore $\text{ord}_{C'}(\text{ft}'_I)^*(ij|kl) = d_1$ on the stack M , by Corollary (2.5) of [Vis89] and the projection formula.

The special loci of C' are C'_0 and the marked points x'_j, x'_k and x'_l . As étale neighbourhoods of x'_j, x'_k and x'_l are not deformed in M° , we conclude from Lemma 3.2.2 that a formal neighbourhood of C' in M is isomorphic to $\text{Def}_{C'_0}^\Delta$. We obtain $\text{Def}_{C'_0}^\Delta \cong \text{Def}_{C'_0}^\Delta$, as C and C' are étale locally isomorphic around C_0 and C'_0 . Furthermore $\text{Def}_C^\Delta \cong \text{Def}_{C_0}^\Delta$ as $\text{vdim}(L_1^m, \Delta) = \dim W_{\Delta,L} = 1$ and hence $\dim \text{Def}_A^\Delta = 0$ for the other special loci A of C . This means that $W_{\Delta,L}$ and M have formal neighbourhoods around C and C' which are isomorphic. Furthermore the forgetful morphisms ft_I and ft'_I to $\overline{M}_{0,I}$ correspond to each other via this isomorphism, thus $\text{ord}_C \text{ft}_I^*(ij|kl) = \text{ord}_{C'}(\text{ft}'_I)^*(ij|kl) = d_1$. \square

Corollary 3.2.12. *Let $C = (C, x_1, \dots, x_n, \pi) \in M_{\Delta,L} \subset \overline{M}_{0,n}(L, d)$ and let C_0 be an irreducible component of C on which π is constant and around which C étale locally looks like in the following picture.*

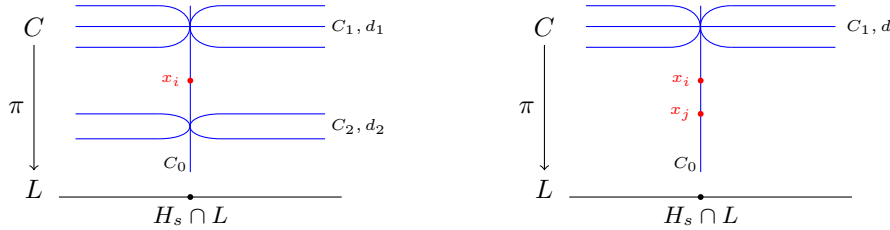

Then $\dim \text{Def}_{C_0}^\Delta = 1$. In particular, C can be deformed into a curve in $M_{\Delta,L}$ having two nodes less than C in the left case and one node less in the right case.

PROOF. This follows immediately from the proofs of the previous two lemmas. \square

Before we state and prove the main theorem of this section, we should make the following remark.

Remark 3.2.13. By arguments very similar to those in Example 1.6.7, one can show that all vertex types $(L_0^{m-1} \times \mathbb{R}, \Delta)$ are good with respect to the moduli data chosen in Definition 3.2.8.

Theorem 3.2.14. *All vertex types (L_1^m, Δ) are good with respect to the moduli data chosen in Definition 3.2.8.*

PROOF. We will proceed by induction on the classification number, cf. Definition 1.5.6. The smallest possible value is $N_{[(L_1^m, \Delta)]} = 2m + 1$, which is attained only for the degree $\Delta' = (e_0, \dots, e_m)$ and which is of resolution dimension zero. Vertex types of resolution dimension zero are always good. If $\text{rdim}(L_1^m, \Delta) > 1$ we can assume by induction that all vertices in non-trivial combinatorial types of degree Δ curves in L_1^m are good, cf. Lemma 1.5.7. By Lemma 1.5.22 we conclude that then also (L_1^m, Δ) is good. Hence it is sufficient to check that vertex types with $\text{rdim}(L_1^m, \Delta) = 1$ are good, so we will assume that the resolution dimension is one. Let γ be an admissible combinatorial type of degree Δ curves in L_1^m of geometric dimension one. The geometric dimension clearly equals the number of vertices of γ which are *not* mapped to the origin, plus the number of edges of γ which *are* mapped to the origin. So we will have to distinguish two cases.

1st case: The combinatorial type γ has two vertices v and w which are mapped to the origin and are adjacent via a contracted edge. It is easy to see that, without loss of generality, $\text{rdim}(v) = 0$ and $\text{rdim}(w) = 1$. By induction both vertices are good and we can define the gluing cycle $\mathcal{Z}(\gamma)$ as in Construction 1.5.13. The local moduli space of v consists of one cell, which is of weight zero by the Riemann-Hurwitz formula, since $0 \in \Delta_v$. Therefore $[\mathcal{Z}(\gamma)] = [\emptyset]$ and γ does not occur in $\mathcal{M}_0(L_1^m, \Delta)$.

2nd case: There is one vertex v that is not mapped to the origin, and vertices w_1, \dots, w_r which are mapped to the origin. As there are no contracted edges over the origin, the number of edges of γ is r . For a genus zero graph we have

$$\begin{aligned} r &= |\Delta| - 3 - (\text{val}(v) - 3) - \sum_{i=1}^r (\text{val}(w_i) - 3) \\ &\leq |\Delta| - \text{val}(v) - \sum_{i=1}^r ((K_{L_1^m} \cdot \Delta)_{w_i} - 1) = |\Delta| - K_{L_1^m} \cdot \Delta + r - \text{val}(v). \end{aligned}$$

The inequality holds because γ is admissible. Together with $\text{vdim}(L_1^m, \Delta) = 1$ the above inequality yields $\text{val}(v) \leq 3$ and hence $\text{val}(v) = 3$. Therefore either $r = 1$ or $r = 2$ and γ must look as follows.

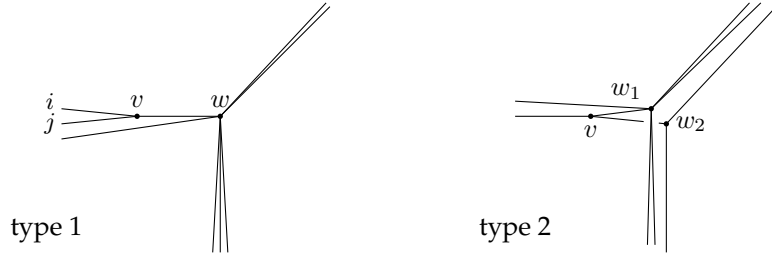

We now want to show that $\mathcal{M}_0(L_1^m, \Delta)$ is equal to the fan $\mathcal{W}_{\Delta, L}$ from Construction 3.1.4, case 1. For this we choose two suitable root leaves to obtain $\mathcal{M}_0(\mathbb{R}^m, \Delta) \cong \mathcal{M}_{0, n} \times \mathbb{R}^m$. In these coordinates $|\mathcal{M}_0(L_{m-1}^m, \Delta)|_{\text{poly}} \subset |\mathcal{M}_{0, n}| \times 0$, hence it suffices to consider only the forgetful morphisms.

First we assume that γ is of type 1 and has a vertex v that is mapped to an edge and is incident to leaves x_i and x_j . There is also a vertex w that is mapped to the origin. Assume that $\mathcal{C} = (C, x_1, \dots, x_n, \pi) \in \overline{\mathcal{M}}_{0, n}(L, d)$ corresponds to type γ . This means, that with the notation from Theorem 2.2.18 the normalisation of C has two irreducible components C^v and C^w such that x_i, x_j are the only marked points of C on C^v . Furthermore π^v is constant and $(C^w, F^w, \pi^w) \in W_{\Delta_w, L}$. By Corollary 3.2.12 \mathcal{C} can be deformed into a curve in $W_{\Delta, L}^\circ$. Hence $|\mathcal{W}_{\Delta, L}(\gamma)| = \deg[W_{\Delta_w, L}] = H_{0, d}(\Delta_w)$. Furthermore, by Lemma 3.2.10 we see that the vector $v_{\mathcal{C}} \in \mathcal{M}_{0, n}$ that is assigned to $\mathcal{C} \in W_{\Delta, L}(\gamma)$ in Construction 3.1.4 equals $v_{\mathcal{C}} = v_{ij}$.

The gluing weight of $\overline{\mathcal{M}(\gamma)}$ is by Example 1.6.2 and our choice of moduli data just $H_{0,d}(\Delta_w)$. Therefore the primitive integral generator of $\overline{\mathcal{M}(\gamma)}$ times the weight is

$$r_\gamma = H_{0,d}(\Delta_w)v_{ij} = |W_{\Delta,L}(\gamma)|v_{\mathcal{C}}.$$

Now assume that γ is of type 2. Let the vertices of γ be called v , w_1 and w_2 where v is mapped into an edge and w_i to the origin for $i = 1, 2$. Denote the labels of the leaves incident to w_i by J_i and let d'_i be the weight of the edge $\{v, w_i\}$, for $i = 1, 2$. Let $\mathcal{C} = (C, x_1, \dots, x_n, \pi) \in \overline{\mathcal{M}}_{0,n}(L, d)$ and let the notation be as in Theorem 2.2.18 again. Assume that \mathcal{C} corresponds to type γ , i.e. $(C^{w_i}, F^{w_i}, \pi^{w_i}) \in W_{\Delta_{w_i}, L}$ for $i = 1, 2$. Furthermore there is only one marked point of C on C^v and π^v is constant. By Corollary 3.2.12 \mathcal{C} can be deformed into a curve in $W_{\Delta, L}^\circ$. Hence $|W_{\Delta, L}(\gamma)| = H_{0,d_1}(\Delta_{w_1})H_{0,d_2}(\Delta_{w_2})$, where $d_i = \frac{1}{m-1}K_{L_1^m} \cdot \Delta_{w_i}$ for $i = 1, 2$. We already know that the vector $v_{\mathcal{C}} \in \mathcal{M}_{0,n}$ that is assigned to $\mathcal{C} \in W_{\Delta, L}(\gamma)$ in Construction 3.1.4 represents a tropical stable map of combinatorial type γ . From Lemma 3.2.11 we obtain $v_{\mathcal{C}} = d'_2 v_{J_1} + d'_1 v_{J_2}$.

The gluing weight of $\overline{\mathcal{M}(\gamma)}$ is by Example 1.6.1 just $\gcd(d'_1, d'_2)H_{0,d_1}(\Delta_{w_1})H_{0,d_2}(\Delta_{w_2})$, so the primitive integral generator of $\overline{\mathcal{M}(\gamma)}$ times the weight equals

$$r_\gamma = H_{0,d_1}(\Delta_{w_1})H_{0,d_2}(\Delta_{w_2})(d'_2 v_{J_1} + d'_1 v_{J_2}) = |W_{\Delta, L}(\gamma)|v_{\mathcal{C}}.$$

We conclude that $\mathcal{M}_0(L_1^m, \Delta)$ is equal to $\mathcal{W}_{\Delta, L}$ and by Lemma 3.1.5 it is balanced. \square

Corollary 3.2.15. *Let the moduli data be as in Definition 3.2.8 and let $\mathcal{X} \subset \mathbb{R}^k$ be a closed smooth tropical curve. Then $\mathcal{M}_0(\mathcal{X}, \Delta)$ is a tropical variety of dimension*

$$|\Delta| - K_{\mathcal{X}} \cdot \Delta - 2.$$

PROOF. That $\mathcal{M}_0(\mathcal{X}, \Delta)$ is a tropical variety follows from Theorem 3.2.14, Remark 3.2.13 and Theorem 1.5.21, the claim about the dimension follows from Lemma 1.5.18. \square

Remark 3.2.16 (Recursively computing Hurwitz numbers). If $\dim W_{\Delta, L} = 1$ we constructed a fan $\mathcal{W}_{\Delta, L}$ in Construction 3.1.4, case 1. We determined its weights in the proof of Theorem 3.2.14 and showed that it equals $\mathcal{M}_0(L_1^m, \Delta)$, hence it can be determined by combinatorics. To say that $\mathcal{W}_{\Delta, L}$ is balanced with these weights is a nice and organised way to state that there are actually plenty of relations between different multi-point Hurwitz numbers. But these relations are not very nice to write down explicitly.

For example, consider $\Delta = (4e_1, 2e_2, e_2, e_2, 2e_0, e_0, e_0)$ and let $\Delta_1 := (e_0, e_1, e_2)$, $\Delta_2 := (2e_0, 2e_1, e_2, e_2)$, $\Delta_3 = (3e_0, 2e_1, e_1, 2e_2, e_2)$ and $\Delta_4 := (4e_0, 3e_1, e_1, 2e_2, e_2, e_2)$. Then applying the tropical forgetful map $\text{ft}_{\{1,2,3,5\}}$ to the sum of weighted primitive integral generators of $\mathcal{W}_{\Delta, L}$, we obtain the following equalities:

$$\begin{aligned} & 3H_{0,1}(\Delta_1)H_{0,3}(\Delta_3) \\ &= H_{0,4}(\Delta_4) + H_{0,1}(\Delta_1)H_{0,3}(\Delta_3) \\ &= 2H_{0,2}(\Delta_2)^2 + H_{0,1}(\Delta_1)H_{0,3}(\Delta_3). \end{aligned}$$

It is easy to see that $H_{0,1}(\Delta_1) = H_{0,2}(\Delta_2) = 1$. Using the above equations we find $H_{0,3}(\Delta_3) = 1$ and $H_{0,4}(\Delta_4) = 2$. We will now sketch why this sort of relations even suffices to inductively compute all multi-point Hurwitz numbers from one initial value.

Fix $m \geq 2$ and let $\Delta_1 = (e_0, \dots, e_m)$. The initial value that we need is then just $H_{0,1}(\Delta_1) = 1$. Let $d > 1$ and assume by induction that all m -point Hurwitz numbers of degree less than d have already been computed. Let $\Delta = (\delta_1, \dots, \delta_n)$ be a degree of tropical curves in L_1^m with $\text{vdim}(L_1^m, \Delta) = 0$ and $d = \frac{1}{m-1}K_{L_1^m} \cdot \Delta$. Assume without loss of generality that $\delta_1 = ae_0$, $\delta_2 = be_1$, $\delta_3 = ce_2$ and that $a > 1$, which is possible as $d > 1$ and $\text{vdim}(L_1^m, \Delta) = 0$. Choose any partition $a = a_0 + a_1$ into positive integers and define $\delta'_0 = a_0e_0$, $\delta'_1 = a_1e_0$ and $\delta'_i = \delta_i$ for $i = 2, \dots, n$. Let $\Delta' = (\delta'_0, \dots, \delta'_n)$. Then $\text{vdim}(L_1^m, \Delta') = 1$ and hence $\dim W_{\Delta', L} = 1$. We obtain a tropical fan $\mathcal{W}_{\Delta', L}$ as above. We apply the tropical forgetful map $\text{ft}_{\{0,1,2,3\}}$

to the weighted sum R of the primitive integral vectors of the fan $\mathcal{W}_{\Delta', L}$. Only one combinatorial type of type 1 from Figure 4 will contribute something to $\text{ft}_{\{0,1,2,3\}}(R)$, namely $H_{0,d}(\Delta)v_{01}$. All other combinatorial types that contribute to $\text{ft}_{\{0,1,2,3\}}(R)$ need to be of type 2 from Figure 4, by the choice of directions for the leaves x_0, \dots, x_3 . Therefore all other Hurwitz numbers that will occur in the coefficients of v_{01}, v_{02} and v_{03} in $\text{ft}_{\{0,1,2,3\}}(R)$ are of strictly smaller degree and hence already known. As the coefficients of v_{01}, v_{02} and v_{03} in $\text{ft}_{\{0,1,2,3\}}(R)$ are equal by Lemma 3.1.5, this proves the claim.

3.3. Lines in smooth tropical surfaces, the tropical cubic

In this section we want to construct moduli spaces of tropical lines in a smooth tropical surface $\mathcal{X} \subset \mathbb{R}^3$. It turns out that that the dimension of such a moduli space will be $3 - \text{deg } \mathcal{X}$, so it is empty for $\text{deg } \mathcal{X} > 3$ and we obtain a finite number of lines counted with multiplicities for $\text{deg } \mathcal{X} = 3$. Throughout this section let $\mathcal{X} \subset \mathbb{R}^3$ be a closed smooth tropical surface, unless specified otherwise, which is equipped with its unique coarsest polyhedral structure. Furthermore we fix the moduli data from Conjecture 3.1.7.

Definition 3.3.1 (Tropical lines). A tropical line in \mathbb{R}^m is an element in $\mathcal{M}_0(\mathbb{R}^m, \mathbf{1}_m)$, where $\mathbf{1}_m = (e_0, \dots, e_m)$.

First we want to see which local combinatorial situations can occur. We want to use decorations on the graph of the tropical line as in [Vig10] to describe the local combinatorial situation. A bold dot indicates that the tropical line passes through a 0-dimensional cell of \mathcal{X} and a bold line indicates that the tropical line passes through a 1-dimensional cell of \mathcal{X} . If a vertex of the tropical line is mapped into a 1-dimensional cell of \mathcal{X} , we want to consider its vertex type modulo this 1-dimensional cell later on. Therefore, in the case of a bold line decoration, we want to distinguish whether an edge of the tropical line is mapped into the 1-dimensional cell or not. There are two possibilities for a four-valent vertex mapping into a 1-dimensional cell of \mathcal{X} . All edges of the tropical line could be mapped into maximal cells of \mathcal{X} , which is the situation we mean by the second picture from the right. Alternatively, one edge of the tropical line might be mapped into the 1-dimensional cell of \mathcal{X} , which is the situation we mean by the last picture on the right. There cannot be more edges of the tropical line that are mapped into a 1-dimensional cell of \mathcal{X} as there is exactly one (up to scalar multiples) linear relation between the elements in $\mathbf{1}_3$. So all possible local situations are those from the following picture.

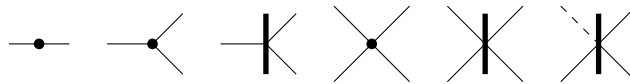

Definition 3.3.2 (Degree of a surface). We denote the intersection product (as defined in [AR10], Section 9) of tropical cycles in \mathbb{R}^3 by $\cdot_{\mathbb{R}^3}$. For a closed tropical surface $\mathcal{X} \subset \mathbb{R}^3$ the degree is defined as $\text{deg } \mathcal{X} := \text{deg}(\mathcal{X} \cdot_{\mathbb{R}^3} [L_1^3])$, cf. Definition 9.12 of [AR10].

Let $(\Gamma, x_1, \dots, x_4, h)$ be a tropical line in \mathcal{X} . By the tropical projection formula we have $K_{\mathcal{X}} \cdot \mathbf{1}_3 = \text{deg } K_{\mathcal{X}} \cdot h_* \Gamma$ and by Corollary 9.8 of [AR10] and by definition of the canonical divisor we obtain $K_{\mathcal{X}} \cdot h_* \Gamma = \mathcal{X} \cdot_{\mathbb{R}^3} h_* \Gamma$. We want to use the recession cycle $\delta(\mathcal{Z})$ of a tropical variety \mathcal{Z} , which is defined in [AR08]. The recession cycle is basically what we obtain if we shrink all bounded cells of \mathcal{Z} to a point and translate this to the origin. By Theorem 12 of [AR08] we obtain

$$(61) \quad K_{\mathcal{X}} \cdot \mathbf{1}_3 = \text{deg } \delta(\mathcal{X} \cdot_{\mathbb{R}^3} h_* \Gamma) = \text{deg}(\delta(\mathcal{X}) \cdot_{\mathbb{R}^3} \delta(h_* \Gamma)) = \text{deg}(\mathcal{X} \cdot_{\mathbb{R}^3} [L_1^3]) = \text{deg } \mathcal{X}.$$

This means that for every vertex v of the tropical line we have $(K_{\mathcal{X}} \cdot \mathbf{1}_3)_v \leq \text{deg } \mathcal{X}$. Now we want to see which vertex types can actually occur for the six possible local situations from above. By definition every admissible vertex type must satisfy $\text{val}(v) \geq (K_{\mathcal{X}} \cdot \mathbf{1}_3)_v + 1$ for the bold dot decorations and $\text{val}(v) \geq (K_{\mathcal{X}} \cdot \mathbf{1}_3)_v + 2$ for the bold line decorations. This







$(K_{\mathcal{X}} \cdot \mathbf{1}_3)_v$							
1	0 (A)	1 (B)	0 (D)	2 (E)	X	1 (I)	
2	X	0 (C)	X	1 (F)	0 (H)	0 (J)	
3	X	X	X	0 (G)	X	X	

FIGURE 5. Possible local situations and their resolution dimensions (we will refer to these situations by the letters in brackets)

already shows that we must have $(K_{\mathcal{X}} \cdot \mathbf{1}_3)_v \leq 3$, as the valency is bounded by 4. Figure 5 lists all possible local situations, the impossible ones are marked with an "X". Most of them can already be excluded by the previous valency considerations. Only the 4-valent type of degree one above type H has to be excluded by a different argument: there is one maximal cell of \mathcal{X} into whose relative interior two edges of the tropical line are mapped. Therefore $(K_{\mathcal{X}} \cdot \mathbf{1}_3)_v$ must be at least two.

Now we want to determine the different possible vertex types that can occur for tropical lines in \mathcal{X} and check that they are good in the sense of Definition 1.5.12. By Lemma 1.5.22 it suffices to check those vertex types of resolution dimension one.

TYPE B: For the 3-valent case of degree 1 with a bold dot, it is easy to see that the only vertex type is $(L_2^3, (e_0, e_1, e_2 + e_3))$. This is a good vertex type as seen in Example 1.6.3.

TYPE F: For a vertex type (L_2^3, Δ) of type F with degree $\Delta = (\delta_1, \delta_2, \delta_3, \delta_4)$ the only linear relation between the δ_j (up to scalar multiples) has to be $\sum_{j=1}^4 \delta_j = 1$, as this is the case for $\mathbf{1}_3$. Furthermore, no curve of degree Δ is allowed to have a bounded edge of weight bigger than one, as we consider tropical lines. Using these two facts it is not difficult to figure out that the only possibility for Δ (up to isomorphisms) is $\delta_1 = 2e_0 + e_1, \delta_2 = e_1 + e_3, \delta_3 = e_2$ and $\delta_4 = e_2 + e_3$.

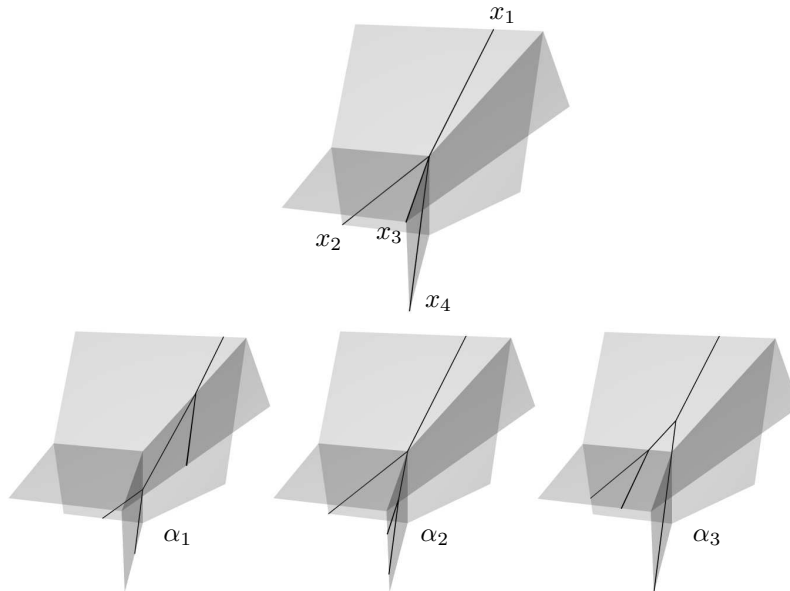

The picture above shows all combinatorial types of degree Δ curves in L_2^3 . If we consider $\mathcal{M}_0(L_2^3, \Delta)$ in barycentric coordinates, the primitive generator of the ray $\mathcal{M}(\alpha_1)$ is $v_{13} + \frac{1}{2}(e_0 + e_3)$, the one of $\mathcal{M}(\alpha_2)$ is $v_{12} + e_1 + \frac{1}{2}e_0$ and the one of $\mathcal{M}(\alpha_3)$ is $v_{14} + e_2 + \frac{1}{2}e_3$. This is balanced with weights 1, which are actually the gluing weights.

TYPE I: By Lemma 1.5.23 this reduces to the case of L_1^2 , where all vertices are good by Theorem 3.2.14. That the moduli data are the same follows from Lemma 3.2.7 and was already mentioned in Definition 3.2.8.

Proposition 3.3.3. *The moduli space of lines $\mathcal{M}_0(\mathcal{X}, \mathbf{1}_3)$ in \mathcal{X} is a tropical variety of dimension $3 - \deg \mathcal{X}$. In particular the moduli space consists of finitely many (weighted) points if $\deg \mathcal{X} = 3$ and it is empty if $\deg \mathcal{X} > 3$.*

PROOF. That $\mathcal{M}_0(\mathcal{X}, \mathbf{1}_3)$ is a tropical variety follows from Theorem 1.5.21 since all possible vertex types are good, as seen above. The dimension can be calculated using Lemma 1.5.18 and (61):

$$\dim \mathcal{M}_0(\mathcal{X}, \mathbf{1}_3) = \dim \mathcal{X} + |\mathbf{1}_3| - 3 - K_{\mathcal{X}} \cdot \mathbf{1}_3 = 2 + 4 - 3 - \deg \mathcal{X}.$$

□

Example 3.3.4. This example of lines in a tropical cubic surface was introduced to me by Cristhian Garay. Consider a floor decomposed generic cubic surface where the three walls (represented by a line, a conic and a cubic) have the following relative position to each other (projected into the e_3 direction):

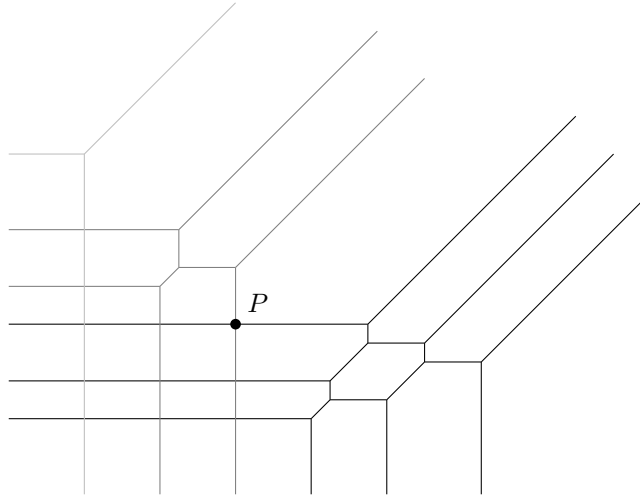

The 0-dimensional cell P of \mathcal{X} lies on the lowest floor, whose projection we obtain by erasing the tropical line from the above picture. Such a cubic surface contains exactly 27 tropical lines which all count with multiplicity one, but in addition it contains a family of lines which does not contain any of the 27 other tropical lines.

All tropical lines in this family have a vertex which is mapped to P , while the rest of the tropical line is mapped into the relative interior of maximal cells of \mathcal{X} . I.e. the lines are decorated as in the picture below.

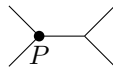

If the vertex that is mapped to P is three-valent, it has to be of resolution dimension -1 . Therefore the only admissible line in the family is the one where there is no bounded edge, i.e. the line where a four-valent vertex is mapped to P . This vertex is then of resolution dimension zero and we now want to determine its vertex type. The directions of the unbounded 1-dimensional cells of \mathcal{X} are known, they are just e_0, e_1, e_2 and e_3 . From this, smoothness of \mathcal{X} and the "map" of the lowest floor from above, we can determine the (outgoing) direction vectors of the four 1-dimensional cells of \mathcal{X} adjacent to P . They are $f_1 = -e_1 + e_3, f_2 = e_1 - 2e_3, f_3 = -e_2 - 2e_3$ and $f_0 = e_2 + 3e_3$. Applying the automorphism

of \mathbb{R}^3 which maps $f_i \mapsto e_i$ for $i = 0, \dots, 3$, we obtain that the vertex type we are looking for is (L_2^3, Δ) with $\Delta = (3e_0 + 2e_1, e_1 + e_2, e_2 + e_3, e_2 + 2e_3)$. Computations as in Remark 2.3.5 show that $[W_{\Delta, H}]^{vir} = 0$ for a hyperplane $H \subset \mathbb{P}^3$ which tropicalises to L_2^3 . Hence the weight of this vertex type, which is also the weight of the tropical line, is zero. Therefore our moduli space consists of exactly 27 lines as one would expect.

Conjecture 3.3.5. For every smooth cubic surface \mathcal{X} we have $\deg \mathcal{M}_0(\mathcal{X}, 1_3) = 27$.

3.4. Examples for computing weights $\deg [W_{\Delta, Y}]^{vir}$

In this section we want to use the theory we developed up to now to determine the weights of all vertex types in L_2^3 with $K_{L_2^3} \cdot \Delta = 2$. We already met some of them, e.g. the weights of types D and E were computed in Example 2.3.6. The most interesting case is type C, where we have $\dim W_{\Delta, H} = 1$ even though $\text{vdim}(L_2^3, \Delta) = 0$, cf. Example 2.3.7. We can only have negative weights when the dimension is bigger than the expected dimension and this example shows that this actually happens.

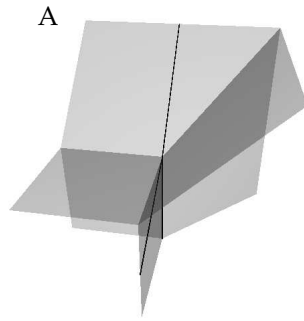

$$\Delta = (e_3, 2e_2 + e_3, 2e_0 + 2e_1)$$

$$\deg [W_{\Delta, H}]^{vir} = \frac{1}{2}$$

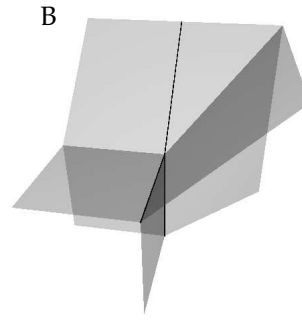

$$\Delta = (2e_3, 2e_2, 2e_0 + 2e_1)$$

$$\deg [W_{\Delta, H}]^{vir} = \frac{1}{2}$$

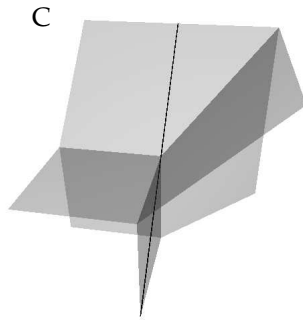

$$\Delta = (2e_3 + 2e_2, e_0 + e_1, e_0 + e_1)$$

$$\deg [W_{\Delta, H}]^{vir} = -\frac{1}{2}$$

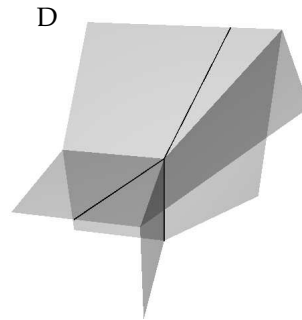

$$\Delta = (2e_3, e_1 + 2e_2, 2e_0 + e_1)$$

$$\deg [W_{\Delta, H}]^{vir} = 1$$

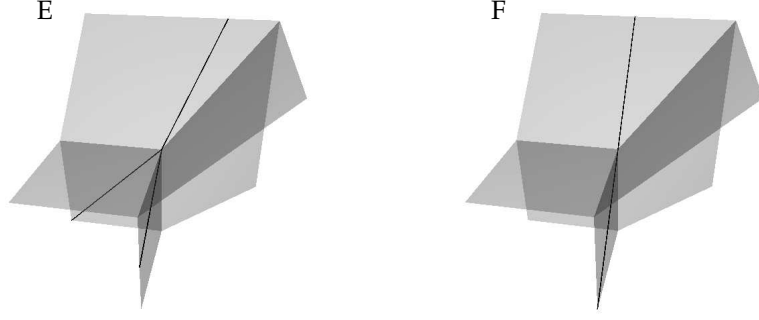

$$\Delta = (e_3 + 2e_2, 2e_0 + e_1, e_1 + e_3)$$

$$\deg [W_{\Delta, H}]^{vir} = 1$$

$$\Delta = (0, 2e_2 + 2e_3, 2e_0 + 2e_1)$$

$$\deg [W_{\Delta, H}]^{vir} = 0$$

The strategy of computing these weights is similar to Remark 3.2.16. We will take some degree of tropical curves such that the virtual dimension is one, and some of the vertex types from above occur in one dimensional combinatorial types. We then use results from Section 3.1 to obtain relations between the numbers we are looking for and numbers that we already know. A good approach is to consider tropical degrees in L_3^4 , as the vertex types from above then occur as projections of resolutions which have only one vertex and hence are particularly easy to understand.

Example 3.4.1 (Type A). Consider the degree $\Delta = (2e_0 + e_1, e_1 + e_2, e_2 + 2e_3 + 2e_4)$ of tropical curves in L_3^4 which has $\text{vdim}(L_3^4, \Delta) = 1$. Let $H \subset \mathbb{P}^4$ denote a hyperplane which tropicalises to L_3^4 and let D_i denote the coordinate hyperplanes of \mathbb{P}^4 , for $i = 0, \dots, 4$. First we want to determine all non-trivial combinatorial types of degree Δ curves in L_3^4 of geometric dimension one and we will see that their number is four. There are three obvious ones γ_2, γ_3 and γ_4 , which are given by moving the trivial combinatorial type into directions e_2, e_3 and e_4 . But there is also one other resolution γ_1 consisting of two vertices, a two-valent one in the origin and a three-valent one in the relative interior of the cone σ_{012} . There are also resolutions of these combinatorial types, but one can check that the only irreducible boundary divisors of W_{Δ, \mathbb{P}^4} are $W_{\Delta, \mathbb{P}^4}(\gamma_i)$ for $i = 1, \dots, 4$.

Using barycentric coordinates to embed $\mathcal{M}_0(L_3^4, \Delta) \hookrightarrow \mathcal{M}_{0,3} \times \mathbb{R}^4 \cong \mathbb{R}^4$, we see that the rays $\mathcal{M}(\gamma_i)$ have the primitive integral vectors $v_{\gamma_1} = 2e_0 + 2e_1 + e_2, v_{\gamma_2} = e_2, v_{\gamma_3} = e_3$ and $v_{\gamma_4} = e_4$. By Lemma 3.1.6 we know that v_{γ_i} equals the vector that is associated to $W_{\Delta, \mathbb{P}^4}(\gamma_i)$ in Construction 3.1.4. We abbreviate $\omega_i := \deg c_{top}(E_H) \cap [W_{\Delta, \mathbb{P}^4}(\gamma_i)]$ for $i = 1, \dots, 4$. So in the fan $\mathcal{W}_{\Delta, H}$ from Construction 3.1.4, case 2, the primitive integral generator of $\mathcal{M}(\gamma_i)$ times the weight is just $r_i := \omega_i v_{\gamma_i}$ for $i = 1, \dots, 4$.

Let Δ_i be the projection of Δ to $\mathbb{R}^4 / \langle e_i \rangle_{\mathbb{R}}$ and $H_i := D_i \cap H$. It is easy to see that for $i = 2, 3, 4$ we have $W_{\Delta, \mathbb{P}^4}(\gamma_i) \cong W_{\Delta_i, D_i}$ and that the vector bundle E_H from Construction 2.3.3 corresponds to E_{H_i} under this isomorphism. Hence we obtain

$$(62) \quad \omega_i = \deg c_{top}(E_H) \cap [W_{\Delta, \mathbb{P}^4}(\gamma_i)] = \deg c_{top}(E_{H_i}) \cap [W_{\Delta_i, D_i}] = \deg [W_{\Delta_i, H_i}]^{vir}$$

for the weights if $i = 2, 3, 4$. The pairs (L_2^3, Δ_3) and (L_2^3, Δ_4) are both of vertex type E, which is already known to have weight one, i.e. $\omega_3 = \omega_4 = 1$. The tuple (L_2^3, Δ_2) is the vertex type A, whose weight we wish to determine.

We know by Lemma 3.1.5 that $\sum_i r_i = 0$. Consider the image of this sum under the tropical evaluation $\text{ev}_2^{V_{\sigma_{12}}}$ at the leaf x_2 . We obtain

$$2\omega_1 e_0 + e_3 + e_4 \equiv 0 \pmod{V_{\sigma_{12}}}$$

and hence $\omega_1 = \frac{1}{2}$. The tropical evaluation $\text{ev}_1^{V_{\sigma_{01}}}$ now yields

$$\frac{1}{2}e_2 + \omega_2 e_2 + e_3 + e_4 \equiv 0 \pmod{V_{\sigma_{01}}}$$

and therefore $\omega_2 = \frac{1}{2}$.

Example 3.4.2 (Type B). Consider the degree $\Delta = (2e_0 + 2e_1, 2e_2 + e_4, 2e_3 + e_4)$ of tropical curves in L_3^4 . We have $\text{vdim}(L_3^4, \Delta) = 1$. Let $H \subset \mathbb{P}^4$ denote a hyperplane which tropicalises to L_3^4 and let D_i denote the coordinate hyperplanes of \mathbb{P}^4 , for $i = 0, \dots, 4$. There are six relevant combinatorial types of degree Δ curves in L_3^4 . The combinatorial type γ_i for $i = 0, \dots, 4$ occurs if we move the trivial combinatorial type into direction e_i . The combinatorial type γ_5 occurs if we move the trivial combinatorial type into direction $e_2 + e_3 + e_4$. It is not difficult to check that these are the only combinatorial types which contribute to the fan $\mathcal{W}_{\Delta, H}$ from Construction 3.1.4, case 2.

Let the primitive integral generator of $\mathcal{M}(\gamma_i)$ be v_{γ_i} for each $i = 0, \dots, 5$. Furthermore, let $\omega_i := \deg c_{top}(E_H) \cap [W_{\Delta, \mathbb{P}^4}(\gamma_i)]$ for $i = 0, \dots, 5$. So in the fan $\mathcal{W}_{\Delta, H}$ from Construction 3.1.4, case 2, the primitive integral generator of $\mathcal{M}(\gamma_i)$ times the weight is just $r_i := \omega_i v_{\gamma_i}$ for $i = 0, \dots, 5$. By Lemma 3.1.6 we know that $r_i = \omega_i e_i$ for $i = 0, \dots, 4$ and $r_5 = \omega_5(e_2 + e_3 + e_4)$.

Let $H_i := D_i \cap H$ and let Δ_i denote the image of Δ in $\mathbb{R}^4 / \langle e_i \rangle_{\mathbb{R}}$. It is easy to see that $W_{\Delta, \mathbb{P}^4}(\gamma_i) \cong W_{\Delta_i, D_i}$ holds for $i = 0, \dots, 4$ and that the restriction of the vector bundle E_H corresponds to E_{H_i} via this isomorphism. Hence $\omega_i = \deg [W_{\Delta_i, D_i}]^{vir}$ for $i = 0, \dots, 4$ as in (62).

Note that (L_2^3, Δ_2) and (L_2^3, Δ_3) are of vertex type A and hence $\omega_2 = \omega_3 = \frac{1}{2}$. Furthermore (L_2^3, Δ_0) and (L_2^3, Δ_1) are of vertex type D, so $\omega_0 = \omega_1 = 1$. The weight we are looking for is ω_4 , since (L_2^3, Δ_4) is of vertex type B.

We know from Lemma 3.1.5 that $\sum_i r_i = 0$. Tropical evaluation $\text{ev}_1^{V_{\sigma_{01}}}$ yields

$$\frac{1}{2}e_2 + \frac{1}{2}e_3 + \omega_4 e_4 \equiv 0 \pmod{V_{\sigma_{01}}}.$$

This implies $\omega_4 = \frac{1}{2}$. For later use, we also want to determine ω_5 . For this we evaluate with $\text{ev}_2^{V_{\sigma_{24}}}$ and obtain

$$e_0 + e_1 + \frac{1}{2}e_3 + \omega_5 e_3 \equiv 0 \pmod{V_{\sigma_{24}}}$$

and hence $\omega_5 = \frac{1}{2}$.

Example 3.4.3 (Type C). Recall Example 1.6.5, where $\Delta = (e_0 + e_3, e_0 + e_3, 2e_1, 2e_2)$ was a degree of tropical curves in L_2^3 of $\text{vdim}(L_2^3, \Delta) = 1$. In that example, we saw that (L_2^3, Δ) is a good vertex type, with the weights chosen there. Now we want to see, that these weights coincide with those from (57). It can be checked that $\mathcal{M}_0(L_2^3, \Delta)$ and $\mathcal{W}_{\Delta, H}$ from Construction 3.1.4 case 2, have the same supports. Let the notation be as in Example 1.6.5.

Let $H \subset \mathbb{P}^3$ be a hyperplane which tropicalises to L_2^3 and let D_i for $i = 0, \dots, 3$ denote the coordinate hyperplanes of \mathbb{P}^3 . Let E_H be the vector bundle from Construction 2.3.3. Again, we define the weights $\omega_i := \deg c_{top}(E_H) \cap [W_{\Delta, \mathbb{P}^3}(\alpha_i)]$ for $i = 1, \dots, 5$. Let as in Example 1.6.5 r_i be the primitive integral generator of $\mathcal{M}(\alpha_i)$, but only for $i = 2, \dots, 5$. By Lemma 3.1.6 we obtain that $r_2 = v_{12} + e_1 + e_2$, $r_3 = v_{12} + e_0 + e_3$, $r_4 = e_0$ and $r_5 = e_3$ equal the vectors that are associated to $W_{\Delta, \mathbb{P}^3}(\alpha_i)$ in Construction 3.1.4, for $i = 2, \dots, 5$. Let r_1 be the vector associated to $W_{\Delta, \mathbb{P}^3}(\alpha_1)$. Then we must have $\sum_i \omega_i r_i = 0$ by Lemma 3.1.5.

Let $\Delta_2 = (2e_1 + 2e_2, e_0 + e_3, e_0 + e_3)$ and $\Delta_3 = (2e_1, 2e_2, 2e_0 + 2e_3)$. Then (L_2^3, Δ_2) is of type C and (L_2^3, Δ_3) is of type B. We have that $W_{\Delta, \mathbb{P}^3}(\alpha_i) \cong W_{\Delta_i, \mathbb{P}^3}$ for $i = 2, 3$, because the stable maps in both stacks only differ by a collapsed component with three special points. Therefore

$$\omega_i = \deg c_{top}(E_H) \cap [W_{\Delta, \mathbb{P}^3}(\alpha_i)] = \deg c_{top}(E'_H) \cap [W_{\Delta_i, \mathbb{P}^3}] = \deg [W_{\Delta_i, H}]^{vir}$$

for $i = 2, 3$. Here E'_H denotes the vector bundle from Construction 2.3.3 on $W_{\Delta_i, \mathbb{P}^3}$. Clearly E_H corresponds to E'_H under the isomorphism $W_{\Delta, \mathbb{P}^3}(\alpha_i) \cong W_{\Delta_i, \mathbb{P}^3}$. So we want to determine ω_2 . We already know that $\omega_3 = \frac{1}{2}$ from the previous example. We apply the tropical

forgetful morphism ft_I with $I = [4]$ to $\sum_i \omega_i r_i$ and we obtain $\omega_2 v_{12} + \frac{1}{2} v_{12} = 0$ and therefore $\omega_2 = -\frac{1}{2}$.

Example 3.4.4 (Type F). As we saw this several times now, we only want to sketch the computation. Consider the degree $\Delta = (2e_0 + 2e_1, 2e_2, 2e_3 + 2e_4)$ of tropical curves in L_3^4 . We have $\text{vdim}(L_3^4, \Delta) = 1$. Let $H \subset \mathbb{P}^4$ be a hyperplane which tropicalises to L_3^4 . Consider $\mathcal{M}_0(\mathbb{R}^4, \Delta)$ equipped with barycentric coordinates. We find that the primitive integral generators of the rays of $\mathcal{W}_{\Delta, H}$ are $v_i = e_i$ for $i = 0, \dots, 4$ and $v_5 = e_2 + e_3 + e_4$ and $v_6 = e_0 + e_1 + e_2$. Each v_i belongs to a combinatorial type α_i of tropical degree Δ curves in L_3^4 of geometric dimension one. As before let $\omega_i := \deg c_{\text{top}}(E_H) \cap [W_{\Delta, \mathbb{P}^4}(\alpha_i)]$. The number we are looking for is ω_2 . We know from Example 3.4.2 that $\omega_0 = \omega_1 = \omega_3 = \omega_4 = \frac{1}{2}$. Furthermore, we have that $W_{\Delta, \mathbb{P}^4}(\alpha_5)$ and $W_{\Delta, \mathbb{P}^4}(\alpha_6)$ are isomorphic to $W_{\Delta, \mathbb{P}^4}(\gamma_5)$ from Example 3.4.2. The restrictions of the vector bundles E_H correspond to each other via these isomorphisms. So we conclude that also $\omega_5 = \omega_6 = \frac{1}{2}$. By Lemma 3.1.5 we know that

$$0 = \sum_{i=0}^6 \omega_i v_i = e_0 + e_1 + (\omega_2 + 1)e_2 + e_3 + e_4$$

and we conclude $\omega_2 = 0$.

Bibliography

- [AR08] Lars Allermann and Johannes Rau. Tropical rational equivalence on \mathbb{R}^r . 2008. E-print, arXiv:0811.2860.
- [AR10] Lars Allermann and Johannes Rau. First steps in tropical intersection theory. *Mathematische Zeitschrift*, 264(3):633–670, 2010. arXiv:0709.3705.
- [BM96] Kai Behrend and Yuri I. Manin. Stacks of stable maps and Gromov-Witten invariants. *Duke Mathematical Journal*, 85(1):1–60, 1996.
- [Bou72] Nicolas Bourbaki. *Commutative Algebra*. Paris, 1972.
- [Cap11] Lucia Caporaso. Algebraic and tropical curves: comparing their moduli spaces. To appear in Handbook of Moduli, edited by Gavril Farkas and Ian Morrison, 2011.
- [CLS11] David Cox, John Little, and Hal Schenck. *Toric Varieties*. American Mathematical Society, 2011.
- [Cox95] David Cox. The functor of a smooth toric variety. *The Tohoku Mathematical Journal. Second Series*, 47(2):251–262, 1995.
- [Don11] Simon K. Donaldson. *Riemann Surfaces*. Oxford University Press, 2011.
- [Dra08] Jan Draisma. A tropical approach to secant dimensions. *Journal of Pure and Applied Algebra*, 212(2):349–363, 2008.
- [Eis04] David Eisenbud. *Commutative Algebra with a View Toward Algebraic Geometry*. Springer, 2004.
- [FP97] William Fulton and Rahul Pandharipande. Notes on stable maps and quantum cohomology, 1997.
- [FR10] Georges François and Johannes Rau. The diagonal of tropical matroid varieties and cycle intersections. E-print, 2010. arXiv:1012.3260v1.
- [Fra11] Georges François. Cocycles on tropical varieties via piecewise polynomials. 2011. Preprint, arXiv:1102.4783.
- [Fra12] Georges François. *Tropical Intersection Products and Families of Tropical Curves*. PhD thesis, TU Kaiserslautern, 2012.
- [FS97] William Fulton and Bernd Sturmfels. Intersection theory on toric varieties. *Topology*, 36:335–353, 1997.
- [Ful98] William Fulton. *Intersection Theory*. Springer, 2nd edition edition, 1998.
- [Gat02] Andreas Gathmann. Absolute and relative Gromov-Witten invariants of very ample hypersurfaces. *Duke Mathematical Journal*, 115:171–203, 2002.
- [Gil84] Henri Gillet. Intersection theory on algebraic stacks and \mathbb{Q} -varieties. *Journal of Pure and Applied Algebra*, 34:193–240, 1984.
- [GKM09] Andreas Gathmann, Michael Kerber, and Hannah Markwig. Tropical fans and the moduli space of rational tropical curves. *Compositio Mathematica*, 145(1):173–195, 2009. arXiv:0708.2268.
- [GM07] Angela Gibney and Diane Maclagan. Equations for Chow and Hilbert Quotients. Preprint, arXiv:0707.1801, 2007.
- [Ham12] Simon Hampe. a-tint: a polymake extension for tropical intersection theory, 2012, <https://bitbucket.org/hampe/atint>.
- [Har97] Robin Hartshorne. *Algebraic Geometry*. Springer, 8th edition, 1997.
- [Har10] Robin Hartshorne. *Deformation Theory*. Springer, 2010.
- [KM94] Maxim Kontsevich and Yuri I. Manin. Gromov-Witten classes, quantum cohomology, and enumerative geometry. *Communications in Mathematical Physics*, 164(3):525–562, 1994.
- [KM09] Michael Kerber and Hannah Markwig. Intersecting Psi-classes on tropical $\mathcal{M}_{0,n}$. *International Mathematics Research Notices*, no. 2:221–240, 2009.
- [Kon] Maxim Kontsevich. Enumeration of rational curves via torus actions. In *The moduli space of curves (Texel Island, 1994)*, volume 129 of *Progress in Mathematics*, pages 335–368. Birkhäuser, Boston.
- [KP11] Eric Katz and Sam Payne. Realization spaces for tropical fans. In *Combinatorial aspects of commutative algebra and algebraic geometry*, volume 6 of *Abel Symposium*, pages 73–88. Springer, Berlin, 2011.
- [Kre99] Andrew Kresch. Cycle groups for Artin stacks. *Inventiones mathematicae*, 138(3):495–536, 1999.
- [Mik05] Grigory Mikhalkin. Enumerative tropical algebraic geometry in \mathbb{R}^2 . *Journal of the American Mathematical Society*, 18(2):313–377, 2005.
- [Mik06] Grigory Mikhalkin. Tropical geometry and its applications. In *International Congress of Mathematicians. Vol. II*, pages 827–852. European Mathematical Society, Zürich, 2006.
- [Oxl92] James G. Oxley. *Matroid Theory*. Oxford University Press, 1992.
- [Pan98] Rahul Pandharipande. Rational curves on hypersurfaces (after A. Givental). *Astérisque*, (252):Exp. No. 848, 5, 307–340, 1998. Séminaire Bourbaki. Vol. 1997/98.

- [Rau09] Johannes Rau. *Tropical intersection theory and gravitational descendants*. PhD thesis, TU Kaiserslautern, 2009, <https://kluedo.ub.uni-kl.de/files/2122/Published.pdf>.
- [Shu06] Eugenii Shustin. A tropical calculation of the Welschinger invariants of real toric del Pezzo surfaces. *Journal of Algebraic Geometry*, 15(2):285–322, 2006.
- [SM13] Bernd Sturmfels and Diane Maclagan. Introduction to tropical geometry. Work in progress, January 27, 2013, homepages.warwick.ac.uk/staff/D.Maclagan/papers/TropicalBook.html.
- [Spe05] David Speyer. *Tropical Geometry*. PhD thesis, UC Berkeley, 2005, <http://www-personal.umich.edu/~speyer/thesis.pdf>.
- [Spe07] David Speyer. Uniformizing tropical curves I: genus zero and one. 2007. E-print, arXiv:0711.2677.
- [SS04] David Speyer and Bernd Sturmfels. The tropical Grassmannian. *Advances in Geometry*, 4(3):389 – 411, 2004, arXiv:math/0304218.
- [Sta] The Stacks Project Authors. *Stacks Project*. <http://stacks.math.columbia.edu>. Version 7f9ae37, compiled on Jan 08, 2013.
- [Vak00] Ravi Vakil. The enumerative geometry of rational and elliptic curves in projective space. *Journal für die reine und angewandte Mathematik*, 529:101–153, 2000.
- [Vig10] Magnus Dehli Vigeland. Smooth tropical surfaces with infinitely many tropical lines. *Arkiv for Matematik*, 48(1):177–206, 2010. arXiv:0703682.
- [Vis89] Angelo Vistoli. Intersection theory on algebraic stacks and on their moduli spaces. *Inventiones mathematicae*, 97:613 – 670, 1989.

Wissenschaftlicher Werdegang

04.11.1984	geboren in Frankenberg (Eder)
2004	Abitur an der Edertalschule, Frankenberg (Eder)
10/2004	Studium der Mathematik an der Philipps-Universität Marburg
04/2007	Studium der Mathematik an der TU Kaiserslautern
09/2009	Diplom in Mathematik, TU Kaiserslautern
seit 10/2009	Doktorand bei Prof. Dr. Andreas Gathmann, TU Kaiserslautern

Curriculum Vitae

04/11/1984	born in Frankenberg (Eder)
2004	Abitur at the Edertalschule, Frankenberg (Eder)
10/2004	Study of mathematics at the Philipps-University Marburg Germany
04/2007	Study of mathematics at the University of Kaiserslautern, Germany
09/2009	Diplom in Mathematics, University of Kaiserslautern
since 10/2009	Ph.D. studies with Prof. Dr. Andreas Gathmann, University of Kaiserslautern